



**NOVELLINI**



# INDICE



## BOX DOCCIA

---

013	N180	119	KUADRA 2.0
023	YOUNG PLUS	135	ROSE ROSSE
035	YOUNG	161	ZEPHYROS 2.0
073	GALA	187	LUNES
083	LOUVRE	217	STAR 2.0
091	BRERA	235	FREE
105	OPERA	249	RIVIERA



## SPAZI DOCCIA

---

257	KUADRA H
273	KUADRA H FRAME COLLECTION
288	KUADRA H IN ART
295	H STYLE
299	H ART
305	GIADA EDGE COLLECTION
318	LUNES H



## PIATTI DOCCIA

---

323	NOVOSOLID
327	NOVOMATT
331	CUSTOM TOUCH
335	CUSTOM
339	OLYMPIC PLUS
341	OLYMPIC
343	VICTORY



## COLONNE DOCCIA

---

346	F
347	Z
348	LINE
350	EASY
351	REVIF
352	DRESS
355	VANITY



## CABINE DOCCIA

---

359	SKILL	427	MEDIA GLASS
367	GLAX 1	435	MEDIA
379	GLAX 2	457	REVOLUTION
391	CRYSTAL		
399	EON		
413	NEW HOLIDAY		



## VASCHE

---

479	INFINITIVE	541	CALOS
483	SHIP	545	CALYPSO
489	DIVINA	547	UNA
515	STILE	549	VOGUE
525	SENSE	551	VENUS
537	IRIS	552	BABY



## PARETI VASCA

---

584	GALA
585	KUADRA
586	YOUNG
589	ROSE ROSSE
591	AURORA
600	RIVIERA



## COMPLEMENTI

---

604	ACCESSORI EDGE	646	PROFILI
610	ACCESSORI FRAME	652	SOLE
631	RUBINETTERIA		
637	ACCESSORI PER BOX E SPAZI DOCCIA		
644	MANIGLIE		
645	ACCESSORI PER VASCHE		



## OUTDOOR SPA

---

661	MOON
665	DIVINA SPA
681	VITA
689	COMPLEMENTI

 **100% MADE IN ITALY**



ITALIAN PLANT NOVELLINI

I valori famigliari sono le fondamenta ed il timone dell'attività imprenditoriale della famiglia Novellini. Generazione dopo generazione, passione, impegno, innovazione e creatività, oltre che una spasmodica attenzione alle esigenze del cliente, costituiscono i valori perseguiti da Novellini.

Il Gruppo Novellini é leader in Europa nella produzione di box doccia, cabine e vasche idromassaggio, con stabilimenti in Italia, Filiali nei principali paesi europei e rappresentanze nei diversi continenti.



**1°**

**IL PIÙ GRANDE  
PRODUTTORE EUROPEO**



**160.100.000**

**FATTURATO  
CONSOLIDATO**



**50**

**PAESI SERVITI  
NEL MONDO**



**737**

**DIPENDENTI**



**9.000**

**CLIENTI**



**15**

**AUTOTRENI SPEDITI  
AL GIORNO**



**10.000 M<sup>2</sup>**

**MAGAZZINO  
ROBOTIZZATO**



**80.000**

**PRODOTTI A STOCK  
GIORNALIERO**

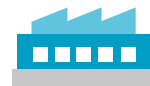

**250.000 M<sup>2</sup>**

**SUPERFICIE COPERTA  
PRODUTTIVA**



**1.000.000**

**PRODOTTI REALIZZATI  
ANNUALMENTE**



# GREEN

## È MOLTO PIÙ CHE UN COLORE: È RESPONSABILITÀ

Il nostro codice etico in materia di ambiente: ogni nostro prodotto è progettato e realizzato per soddisfare le più recenti normative europee in materia di qualità, sicurezza e rispetto dell'ambiente.

L'adozione di processi produttivi a basso impatto ambientale, il controllo dell'immissione di sostanze tossiche e il considerevole risparmio energetico, sono le risposte alle problematiche di un mondo in costante evoluzione. Queste attività hanno permesso a Novellini di essere citata nel 2017 e nel 2019 nel Rapporto Green Italy, come unica Azienda nel nostro settore, ad aver messo in atto nel proprio flusso produttivo azioni e processi ecosostenibili rispettosi per l'ambiente.



### **NOVELLINI HA RECENTEMENTE OTTENUTO LA PROPRIA CERTIFICAZIONE EPD PER 9 GAMME DI BOX DOCCIA E SPAZI DOCCIA.**

EPD (Environmental Product Declaration) è una Dichiarazione Ambientale di Prodotto che definisce l'impatto ambientale del prodotto, in accordo con gli standard internazionali ISO 14025 ed EN 15804.

L'EPD riporta i risultati calcolati attraverso l'analisi del ciclo di vita del prodotto con il metodo LCA (Life Cycle Assessment), valutando il consumo di risorse (materiali, acqua, energia) e gli impatti sull'ambiente circostante nelle varie fasi del ciclo di vita, dall'estrazione delle materie prime al loro trasporto, alla produzione fino alla dismissione del prodotto al termine della vita utile.

**Lunes 2.0, Kuadra 2.0, Young, Opera, Kuadra H e Giada H sono certificati con EPD per un approccio consapevole alla sostenibilità. Il certificato EPDItaly0346 è consultabile presso il sito [www.epditaly.it](http://www.epditaly.it)**

Novellini ha partecipato anche ad una attività di comparto, certificando con EPD le gamme Louvre, Zephyros e Kuadra H, nell'ambito di una EPD media di settore. Il certificato EDP N. S-P-01811 è consultabile presso il sito [www.environdec.com](http://www.environdec.com)

# I SERVIZI A TE DEDICATI



## SEMPRE AL TUO FIANCO

Da oltre vent'anni il **portale web di riferimento per i nostri clienti**.

Centinaia di modelli e ricambi tra cui scegliere, creazione degli ordini in modo rapido ed intuitivo, disponibilità a magazzino visualizzate in tempo reale, promozioni dedicate.

Visita lo Store per rimanere sempre aggiornato sulle novità del mondo Novellini.

[store.novellini.com](http://store.novellini.com)



## IL MONDO NOVELLINI A PORTATA DI APP

Dedicata agli idraulici e ai professionisti del settore. Tutti i **servizi Novellini a tua disposizione con un click**, ovunque ti trovi.

Scarica l'app *Novellini Store Pro* su smartphone Android o Iphone.



IOS



ANDROID



## IL NUOVO VOLTO DEL SERVIZIO CLIENTI

**La nuova piattaforma di ticketing** che ti consente di inoltrare, gestire e monitorare le tue richieste su prodotti e servizi Novellini. Informazioni tecniche e commerciali, modifica e annullo di ordini, resi, interventi di assistenza e molto altro. Ogni processo è automatizzato per garantire un servizio chiaro, veloce e digitalizzato.

Le tue richieste? Ora su *My Novellini*

[mynovellini.novellini.com](http://mynovellini.novellini.com)



## PRODOTTI SEMPRE DISPONIBILI IN GRANDI QUANTITÀ

Gli **IN STOCK** Novellini sono una selezione di **prodotti sempre disponibili a magazzino in grandi quantità**.

Nel listino **IN STOCK** Novellini (richiedilo al tuo agente di zona) o nella sezione dedicata sullo Store, trovi l'elenco completo di questi articoli.

Come identificare un prodotto **IN STOCK** Novellini?

- **BOLLINO BLU**, nel presente listino
-  **CAMIONCINO**, nello Store Novellini

# BOX DOCCIA

INDICE PER MODELLO

## VETRO

		SEMICIRCOLARI - BATTENTI			SEMICIRCOLARI - SCORREVOLI	
8mm	<b>N180</b>					
8mm	<b>YOUNG PLUS</b>					
6mm	<b>YOUNG</b>	p. 63	p. 65,66	p. 64		
8mm	<b>GALA</b>					
6mm	<b>LOUVRE</b>					
6mm	<b>BRERA</b>	p. 97				
8mm	<b>OPERA</b>					
6/8mm	<b>KUADRA 2.0</b>					
6mm	<b>ROSE ROSSE</b>					p. 151
6mm	<b>ZEPHYROS 2.0</b>					p. 177
4/5/6mm	<b>LUNES</b>					p. 205
3/4/5mm	<b>STAR 2.0</b>					p. 221
3/6mm	<b>FREE</b>					
3/4mm	<b>RIVIERA</b>					p. 252

## VETRO

		PORTE SCORREVOLI			PORTE A SOFFIETTO	
8mm	<b>N180</b>					
8mm	<b>YOUNG PLUS</b>					
6mm	<b>YOUNG</b>				p. 50,54	p. 52,56,58
8mm	<b>GALA</b>					
6mm	<b>LOUVRE</b>					
6mm	<b>BRERA</b>					
8mm	<b>OPERA</b>	p. 106,108,110	p. 114			
6/8mm	<b>KUADRA 2.0</b>	p. 120,122	p. 132			
6mm	<b>ROSE ROSSE</b>	p. 138,140,142,143	p. 152	p. 146,148	p. 149	
6mm	<b>ZEPHYROS 2.0</b>	p. 162,166	p. 176	p. 175	p. 173,174	
4/5/6mm	<b>LUNES</b>	p. 192,194	p. 203	p. 200,202	p. 199	
3/4/5mm	<b>STAR 2.0</b>	p. 220		p. 222	p. 225	
3/6mm	<b>FREE</b>				p. 244,245	p. 242,243
3/4mm	<b>RIVIERA</b>	p. 250		p. 252	p. 251	



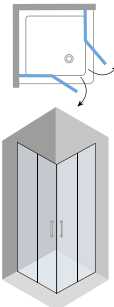
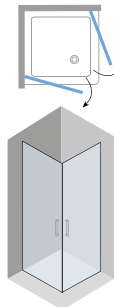
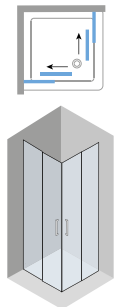
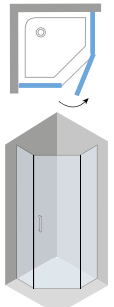

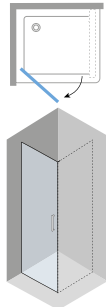
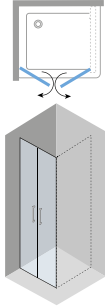
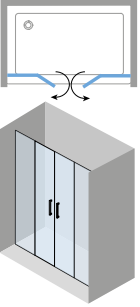
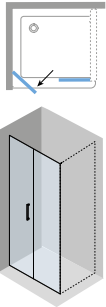
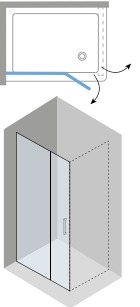
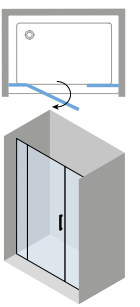
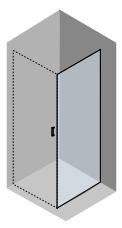
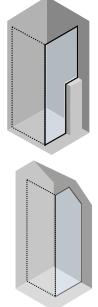
ANGOLO - BATTENTI		ANGOLO - SCORREVOLI	PENTAGONO - BATTENTI
			
	p. 30		
p. 60	p. 48		
p. 88			
p. 96			
		p. 112	
		p. 124	
		p. 136	
		p. 164,168	
		p. 188,190	p. 206
		p. 218	
p. 241	p. 236		
		p. 250	

PORTE BATTENTI						FISSI	SPECIAL
							
p. 14,16			p. 18				
p. 24,28			p. 26				
p. 36,46	p. 40	p. 62	p. 38	p. 42	p. 44	p. 44,46,54	p. 67-69
				p. 74,76,77,78		p. 74,78	
				p. 84,86		p. 84	
				p. 92,94		p. 92	p. 98-101
						p. 106,108,114	
p. 126	p. 127		p. 128			p. 120,130	
p. 144	p. 150					p. 153	p. 154-158
p. 170	p. 172					p. 178	p. 179-183
p. 196	p. 198		p. 204			p. 207,208	p. 210-214
p. 223	p. 224					p. 226	p. 228-232
p. 238-239	p. 240		p. 237			p. 237	
p. 251						p. 253	

# CABINE

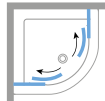
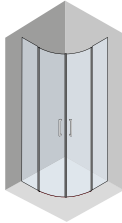
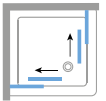
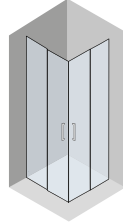
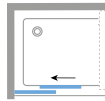
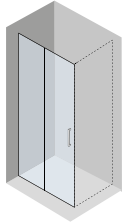
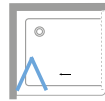
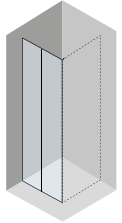
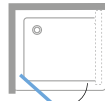
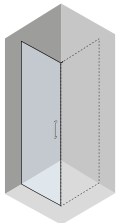
INDICE PER MODELLO

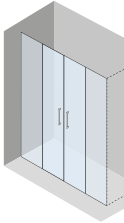
		SEMICIRCOLARI	ANGOLO	PORTE			
<b>VETRO</b>		 	 	 	 	 	 
8mm	<b>SKILL</b>		p. 362	p. 364			p. 360
5/6mm	<b>GLAX 1</b>	p. 374	p. 370,376	p. 368,377		p. 372	
5/6mm	<b>GLAX 2</b>	p. 386	p. 382,388	p. 380,389		p. 384	
6mm	<b>CRYSTAL</b>		p. 394	p. 392		p. 396	
6mm	<b>EON</b>	p. 410	p. 404	p. 400,402		p. 406,408	
4mm	<b>NEW HOLIDAY</b>	p. 422	p. 418	p. 414	p. 416,425	p. 420	
3/4mm	<b>MEDIA GLASS</b>	p. 433	p. 432	p. 428		p. 430	
3mm	<b>MEDIA</b>	p. 440	p. 438	p. 436		p. 437	

# VASCHE

INDICE PER MODELLO

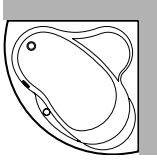
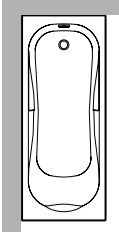
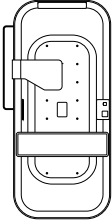
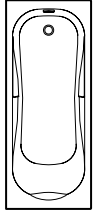
	VASCA ANGOLARE	VASCA RETTANGOLARE	VASCA CENTRO STANZA	VASCA DA INCASSO
				
<b>INFINITIVE</b>	p. 479		p. 479	
<b>SHIP</b>	p. 483		p. 483	
<b>DIVINA DUAL</b>		p. 489	p. 489	p. 489
<b>DIVINA</b>	p. 496,501	p. 505, 509	p. 493, 509	p. 493, 497, 501, 505, 509
<b>STILE</b>	p. 519		p. 519	p. 519
<b>SENSE DUAL</b>		p. 524	p. 524	p. 524
<b>SENSE 2.0</b>		p. 529	p. 529	p. 529
<b>IRIS</b>		p. 537		
<b>CALOS 2.0</b>		p. 541		p. 541
<b>CALYPSO</b>		p. 545		p. 545
<b>UNA</b>	p. 547			p. 547
<b>VOGUE</b>	p. 549			p. 549
<b>VENUS</b>	p. 551			p. 551
<b>BABY</b>				p. 552

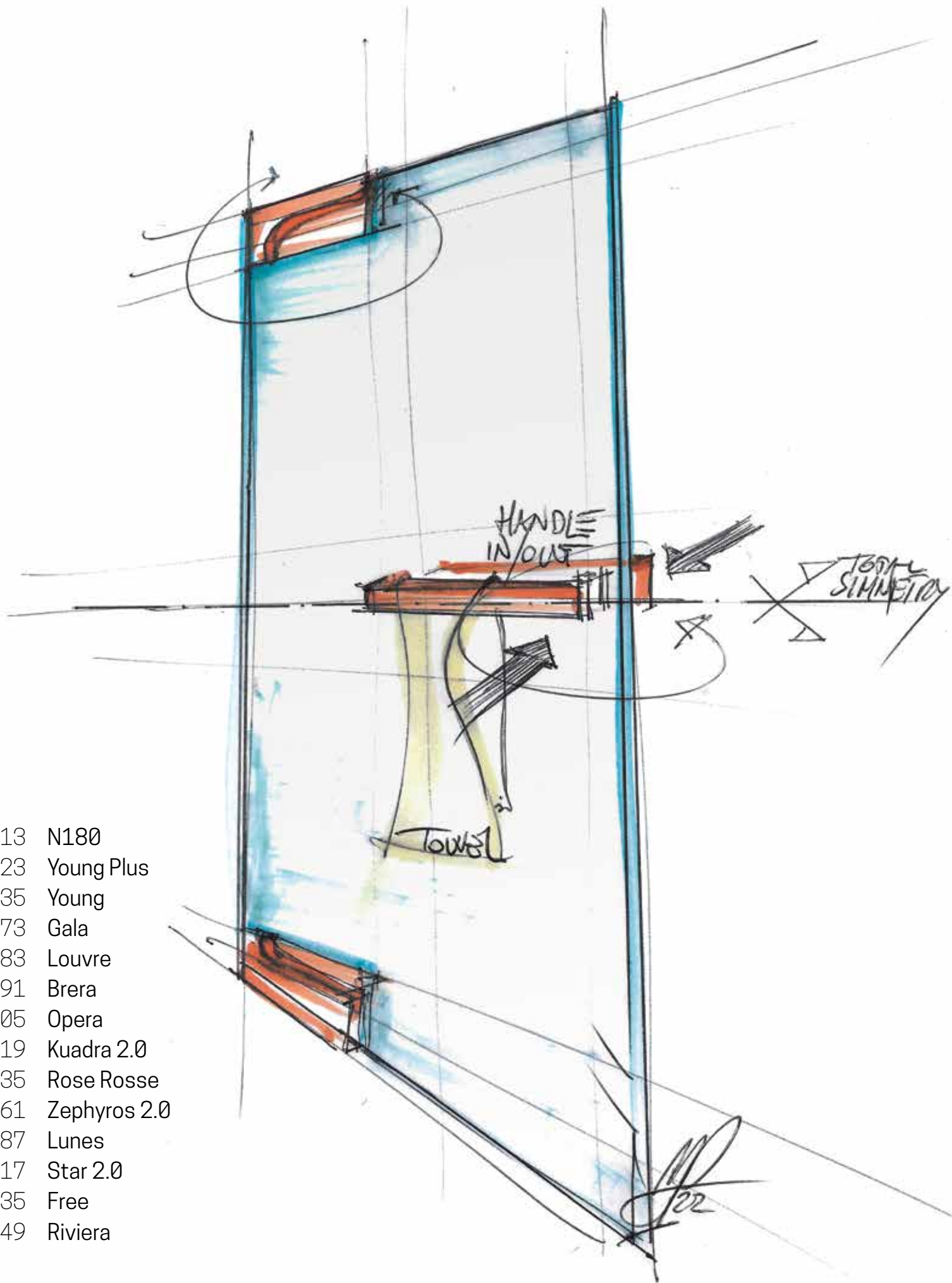

- 013 N180
- 023 Young Plus
- 035 Young
- 073 Gala
- 083 Louvre
- 091 Brera
- 105 Opera
- 119 Kuadra 2.0
- 135 Rose Rosse
- 161 Zephyros 2.0
- 187 Lunes
- 217 Star 2.0
- 235 Free
- 249 Riviera

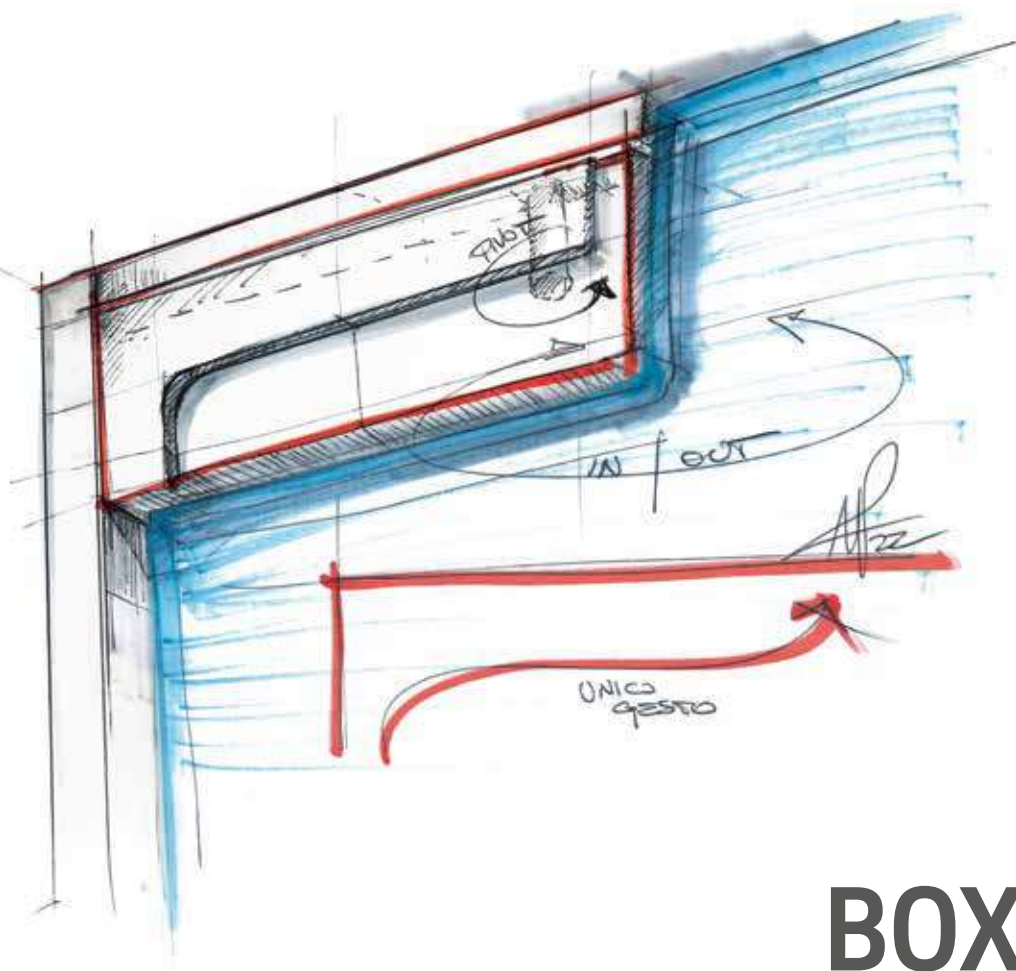

# BOX DOCCIA

UNA SOLUZIONE  
PERFETTA PER  
OGNI DESIDERIO,  
ESIGENZA,  
GUSTO.

La sintesi di comodità e stile in un oggetto di design perfezionato dalle innovazioni delle ultime tecnologie, che lo rendono un prodotto estremamente stabile e sicuro, oltre che altamente personalizzabile.

Quando si sceglie un box Novellini si vuole uno spazio bagno facile da allestire e da mantenere.

La vasta gamma di finiture eleganti, colori e cristalli fa risaltare il tocco di chi vi abita.

# N180

LUMINOSITÀ, ELEGANZA  
E PERSONALITÀ  
NELL'AMBIENTE BAGNO.



◀ Cerniera in/out con blocco  
in apertura a 90° e chiusura  
rallentata



◀ Maniglia



◀ Chiusura con magneti a  
scomparsa

DISPONIBILE DA MARZO 2023

Dettagli, sofisticati accenti visivi e luminosa eleganza fanno di questa gamma di porte a battente un'icona di design.

La rigorosa scelta progettuale combina estetica di immediata eleganza e ricerca delle scelte tecniche con un sistema di chiusura rallentato di elevata ingegnerizzazione.

Le porte N180 sono ideali per creare abbinamenti perfetti con le rubinetterie e i rivestimenti grazie alla vasta scelta di finiture lucide e spazzolate trasformando l'ambiente bagno in un luogo di benessere dove vivere pienamente il piacere dell'acqua.

## TRATTAMENTI





TRASPARENTE / CROMO NERO LUCIDO

# N180

# N180 1B



## PORTA DOCCIA APERTURA 1 ANTA BATTENTE, IN NICCHIA

Design Marco Pellici

Misure			Codice	Scelta vetro	Scelta profilo					
Misura effettiva d'ingombro	Entrata (cm)	Ingombro anta esterno		1	U	B	K	H	O M L	P R Q N Z
<b>A1</b>	*	<b>B</b>		Trasparente	Bianco opaco	Silver	Cromo	Nero opaco	Oro lucido Oro rosa lucido Cromo nero lucido	Oro spazzolato Oro rosa spazzolato Bronzo spazzolato Cromo nero spazzolato Inox spazzolato
77,5↔79	60	59	<b>N1801B79-</b>		900 €	990 €	1.090 €	1.090 €	1.440 €	1.340 €
78,5↔80	61	60	<b>N1801B80-</b>		900 €	990 €	1.090 €	1.090 €	1.440 €	1.340 €
87,5↔89	70	69	<b>N1801B89-</b>		980 €	1.080 €	1.190 €	1.190 €	1.540 €	1.440 €
88,5↔90	71	70	<b>N1801B90-</b>		980 €	1.080 €	1.190 €	1.190 €	1.540 €	1.440 €
97,5↔99	80	79	<b>N1801B99-</b>		1.060 €	1.170 €	1.290 €	1.290 €	1.640 €	1.540 €
98,5↔100	81	80	<b>N1801B100-</b>		1.060 €	1.170 €	1.290 €	1.290 €	1.640 €	1.540 €
H 200 L 80↔100		SPECIAL	<b>N1801BSP</b>		1.374 €	1.512 €	1.668 €	1.668 €	2.018 €	1.918 €

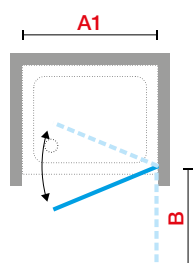
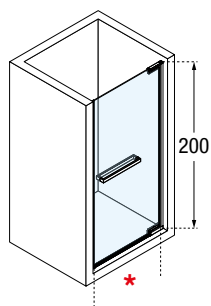





TRASPARENTE / ORO ROSA SPAZZOLATO

## FINITURE VETRI

Trasparente  
cod. 1

## FINITURE PROFILI

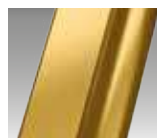
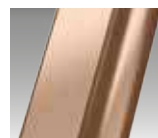
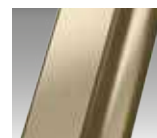
Bianco opaco  
cod. USilver  
cod. BCromo  
cod. KNero opaco  
cod. HOro lucido  
cod. OOro rosa lucido  
cod. MCromo nero  
lucido  
cod. LOro  
spazzolato  
cod. POro rosa  
spazzolato  
cod. RCromo nero  
spazzolato  
cod. NBronzo  
spazzolato  
cod. QInox  
spazzolato  
cod. Z

# N180 G+F



## BOX DOCCIA AD ANGOLO APERTURA 1 ANTA BATTENTE CON 1 PARETE FISSA LATERALE

Design Marco Pellici

Misure					Codice	Scelta vetro	Scelta profilo					
Misura effettiva d'ingombro	Misura centro lastra	Fisso laterale	Entrata (cm)	Ingombro anta		1	U	B	K	H	O M L	P R Q N Z
<b>A</b>	<b>G</b>	<b>F</b>	*	<b>B</b>		Trasparente	Bianco opaco	Silver	Cromo	Nero opaco	Oro lucido Oro rosa lucido Cromo nero lucido	Oro spazzolato Oro rosa spazzolato Bronzo spazzolato Cromo nero spazzolato Inox spazzolato

PORTA												
78↔79,5	76,9↔78,4		61	60	<b>N180G80-</b>	815 €	900 €	990 €	990 €	1.315 €	1.215 €	
88↔89,5	86,9↔88,4		71	70	<b>N180G90-</b>	900 €	990 €	1.090 €	1.090 €	1.415 €	1.315 €	
98↔99,5	96,9↔98,4		81	80	<b>N180G100-</b>	980 €	1.080 €	1.190 €	1.190 €	1.515 €	1.415 €	

H 200					SPECIAL <b>N180GSP</b>	1.272 €	1.404 €	1.548 €	1.548 €	1.873 €	1.773 €	
L 72↔100												

PARETE FISSA												
	76,5↔78	78↔79,5	-	-	<b>N180FG80-</b>	545 €	600 €	660 €	660 €	710 €	685 €	
	86,5↔88	88↔89,5	-	-	<b>N180FG90-</b>	565 €	625 €	690 €	690 €	740 €	715 €	
	96,5↔98	98↔99,5	-	-	<b>N180FG100-</b>	595 €	655 €	720 €	720 €	770 €	745 €	
	116,5↔118	118↔119,5	-	-	<b>N180FG120-</b>	640 €	705 €	780 €	780 €	830 €	805 €	

H 200					SPECIAL <b>N180FGSP</b>	768 €	846 €	936 €	936 €	986 €	961 €	
L 20↔120												

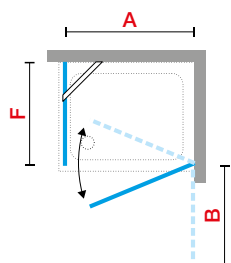
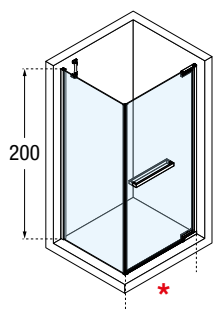

**A/F**  
Misura effettiva d'ingombro

**G**  
Misura centro lastra

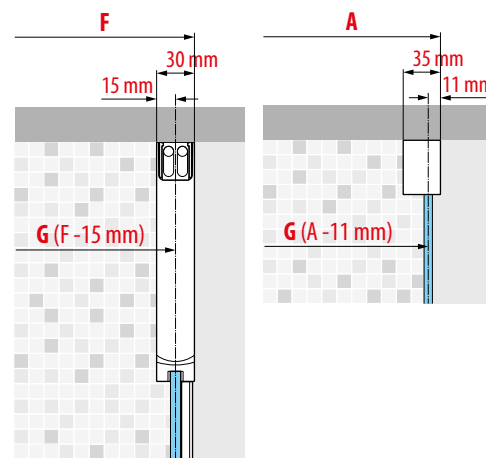



TRASPARENTE / ORO LUCIDO

## FINITURE VETRI

Trasparente  
cod. 1

## FINITURE PROFILI

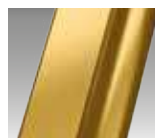
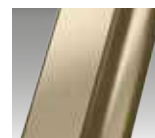
Bianco opaco  
cod. USilver  
cod. BCromo  
cod. KNero opaco  
cod. HOro lucido  
cod. OOro rosa lucido  
cod. MCromo nero  
lucido  
cod. LOro  
spazzolato  
cod. POro rosa  
spazzolato  
cod. RCromo nero  
spazzolato  
cod. NBronzo  
spazzolato  
cod. QInox  
spazzolato  
cod. Z

# N180 G+F IN LINEA



## PORTA DOCCIA APERTURA 1 ANTA BATTENTE E 1 FISSO IN LINEA

Installabile in nicchia o abbinabile a parete fissa laterale N180 F

Design Marco Pellici

Misure					Codice	Scelta vetro	Scelta profilo					
Misura effettiva d'ingombro	Misura centro lastra	Fisso in linea	Entrata (cm)	Ingombro anta esterno		1	U	B	K	H	O M L	P R Q N Z
<b>A</b>	<b>G</b>	<b>F1</b>	*	<b>B</b>		Trasparente	Bianco opaco	Silver	Cromo	Nero opaco	Oro lucido Oro rosa lucido Cromo nero lucido	Oro spazzolato Oro rosa spazzolato Bronzo spazzolato Cromo nero spazzolato Inox spazzolato

PORTA												
97↔100	95,9↔98,9	21↔23	61	60	<b>N180GFL98-</b>	1.140 €	1.260 €	1.390 €	1.390 €	1.765 €	1.640 €	
99↔102	97,9↔100,9	23↔25	61	60	<b>N180GFL100-</b>	1.140 €	1.260 €	1.390 €	1.390 €	1.765 €	1.640 €	
117↔120	115,9↔118,9	21↔23	81	80	<b>N180GFL118-</b>	1.260 €	1.390 €	1.530 €	1.530 €	1.905 €	1.780 €	
119↔122	117,9↔120,9	23↔25	81	80	<b>N180GFL120-</b>	1.260 €	1.390 €	1.530 €	1.530 €	1.905 €	1.780 €	
137↔140	135,9↔138,9	41↔43	81	80	<b>N180GFL138-</b>	1.375 €	1.515 €	1.670 €	1.670 €	2.045 €	1.920 €	
139↔142	137,9↔140,9	43↔45	81	80	<b>N180GFL140-</b>	1.375 €	1.515 €	1.670 €	1.670 €	2.045 €	1.920 €	
157↔160	155,9↔158,9	61↔63	81	80	<b>N180GFL158-</b>	1.435 €	1.585 €	1.750 €	1.750 €	2.125 €	2.000 €	
159↔162	157,9↔160,9	63↔65	81	80	<b>N180GFL160-</b>	1.435 €	1.585 €	1.750 €	1.750 €	2.125 €	2.000 €	
177↔180	175,9↔178,9	81↔83	81	80	<b>N180GFL178-</b>	1.505 €	1.660 €	1.830 €	1.830 €	2.205 €	2.080 €	
179↔182	177,9↔180,9	83↔85	81	80	<b>N180GFL180-</b>	1.505 €	1.660 €	1.830 €	1.830 €	2.205 €	2.080 €	
H 200												
L 92↔200				SPECIAL	<b>N180GFLSP</b>	1.902 €	2.100 €	2.316 €	2.316 €	2.691 €	2.566 €	

FISSO LATERALE												
<b>F</b>												
77,5↔79,5	76↔78				<b>N180F80-</b>	550 €	605 €	670 €	670 €	780 €	740 €	
87,5↔89,5	86↔88				<b>N180F90-</b>	625 €	690 €	760 €	760 €	870 €	830 €	
97,5↔99,5	96↔98				<b>N180F100-</b>	680 €	750 €	825 €	825 €	935 €	895 €	
117,5↔119,5	116↔118				<b>N180F120-</b>	805 €	885 €	978 €	978 €	1.088 €	1.048 €	
H 200												
L 67↔119				SPECIAL	<b>N180FSP</b>	966 €	1.062 €	1.174 €	1.174 €	1.284 €	1.244 €	

### OPTIONAL

BARRA A "T" IN ABBINAMENTO COL FISSO												
	Codice	Scelta profilo										
		U	B	K	H	O M L	P R Q N Z					
			Bianco opaco	Silver	Cromo	Nero opaco	Oro lucido Oro rosa lucido Cromo nero lucido	Oro spazzolato Oro rosa spazzolato Bronzo spazzolato Cromo nero spazzolato Inox spazzolato				
<b>R80BOORT150-</b>	110 €	125 €	140 €	140 €	182 €	168 €						

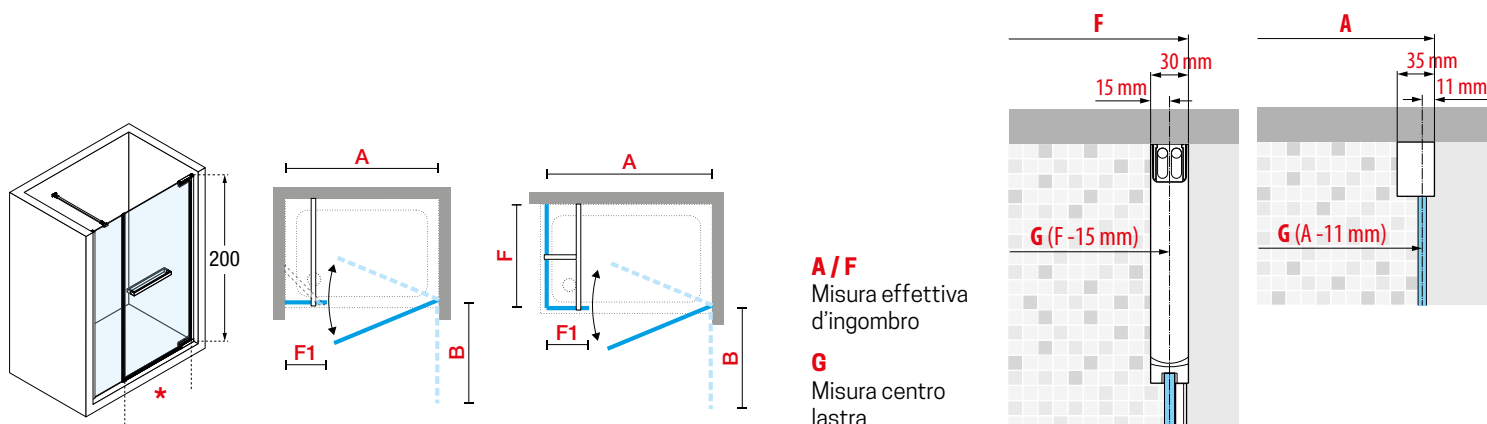

**A/F**  
Misura effettiva d'ingombro

**G**  
Misura centro lastra



TRASPARENTE / BRONZO SPAZZOLATO

## FINITURE VETRI

Trasparente  
cod. 1

## FINITURE PROFILI

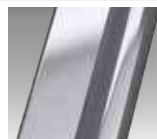
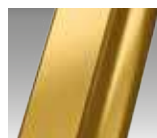
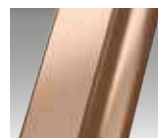
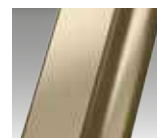
Bianco opaco  
cod. USilver  
cod. BCromo  
cod. KNero opaco  
cod. HOro lucido  
cod. OOro rosa lucido  
cod. MCromo nero  
lucido  
cod. LOro  
spazzolato  
cod. POro rosa  
spazzolato  
cod. RCromo nero  
spazzolato  
cod. NBronzo  
spazzolato  
cod. QInox  
spazzolato  
cod. Z

## DATI TECNICI

### FINITURE PROFILI



Bianco Opaco  
cod. U



Silver  
cod. B



Cromo  
cod. K



Nero opaco  
cod. H

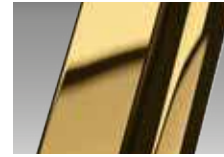

Oro  
lucido  
cod. O



Oro rosa  
lucido  
cod. M



Cromo  
nero lucido  
cod. L

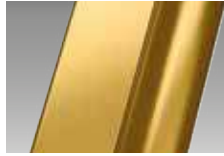

Oro  
spazzolato  
cod. P

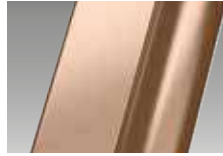

Oro rosa  
spazzolato  
cod. R



Cromo nero  
spazzolato  
cod. N

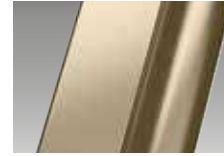

Bronzo  
spazzolato  
cod. Q



Inox  
spazzolato  
cod. Z

### VETRO TEMPRATO 8 mm (European Standards EN 14428)



Trasparente  
cod. 1



### MISURE DI INGOMBRO PROFILI DI FISSAGGIO

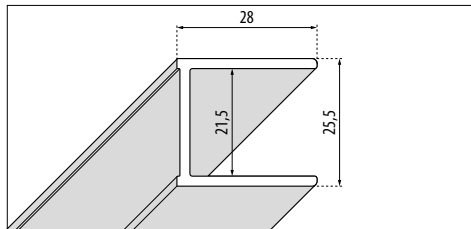

**A MURO**  
per N180 1B - G - GFL

Altezza	Finitura	Codice	Prezzo
1999	Bianco	<b>P01DN1BGST-U</b>	116 €
	Silver	<b>P01DN1BGST-B</b>	128 €
	Cromo	<b>P01DN1BGST-K</b>	141 €
	Nero	<b>P01DN1BGST-H</b>	141 €
	Inox spazzolato	<b>P01DN1BGST-Z</b>	170 €
	Oro lucido	<b>P01DN1BGST-O</b>	184 €
	Oro spazzolato	<b>P01DN1BGST-P</b>	170 €
	Bronzo spazzolato	<b>P01DN1BGST-Q</b>	170 €
	Cromo nero lucido	<b>P01DN1BGST-L</b>	184 €
	Cromo nero spazzolato	<b>P01DN1BGST-N</b>	170 €
	Oro rosa lucido	<b>P01DN1BGST-M</b>	184 €
	Oro rosa spazzolato	<b>P01DN1BGST-R</b>	170 €

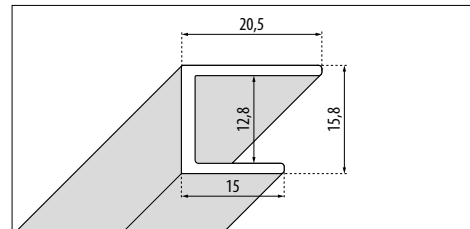

**A MURO**  
per N180 1B - lato magnete

Altezza	Finitura	Codice	Prezzo
1998	Bianco	<b>P04DN1BST-U</b>	100 €
	Silver	<b>P04DN1BST-B</b>	110 €
	Cromo	<b>P04DN1BST-K</b>	121 €
	Nero	<b>P04DN1BST-H</b>	121 €
	Inox spazzolato	<b>P04DN1BST-Z</b>	146 €
	Oro lucido	<b>P04DN1BST-O</b>	158 €
	Oro spazzolato	<b>P04DN1BST-P</b>	146 €
	Bronzo spazzolato	<b>P04DN1BST-Q</b>	146 €
	Cromo nero lucido	<b>P04DN1BST-L</b>	158 €
	Cromo nero spazzolato	<b>P04DN1BST-N</b>	146 €
	Oro rosa lucido	<b>P04DN1BST-M</b>	158 €
	Oro rosa spazzolato	<b>P04DN1BST-R</b>	146 €

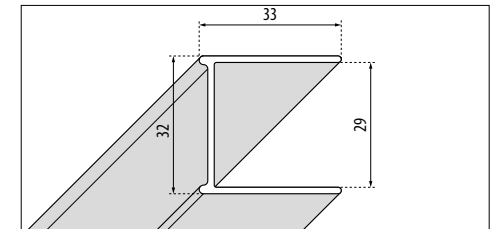

**A MURO**  
per N180 F laterale

Altezza	Finitura	Codice	Prezzo
1999	Bianco	<b>P01BXMOST-U</b>	122 €
	Silver	<b>P01BXMOST-B</b>	135 €
	Cromo	<b>P01BXMOST-K</b>	149 €
	Nero	<b>P01BXMOST-H</b>	149 €
	Inox spazzolato	<b>P01BXMOST-Z</b>	179 €
	Oro lucido	<b>P01BXMOST-O</b>	194 €
	Oro spazzolato	<b>P01BXMOST-P</b>	179 €
	Bronzo spazzolato	<b>P01BXMOST-Q</b>	179 €
	Cromo nero lucido	<b>P01BXMOST-L</b>	194 €
	Cromo nero spazzolato	<b>P01BXMOST-N</b>	179 €
	Oro rosa lucido	<b>P01BXMOST-M</b>	194 €
	Oro rosa spazzolato	<b>P01BXMOST-R</b>	179 €

### COME RILEVARE LE MISURE

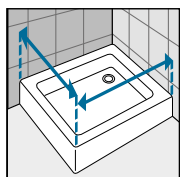

Rilevare le misure da muro a bordo esterno del piatto doccia. Le misure devono essere rilevate sulla parete finita, a rivestimenti posati, secondo gli schemi riportati.

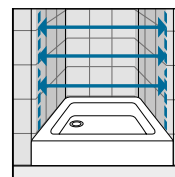

Rilevare le misure da muro a muro, in basso, in alto, al centro e utilizzare quella di valore inferiore. Le misure devono essere rilevate sulla parete finita, a rivestimenti posati, secondo gli schemi riportati.



TRASPARENTE / INOX SPAZZOLATO



# YOUNG PLUS

LO SPESSORE DELL’AFFIDABILITÀ.



◀ Profili portamagnete

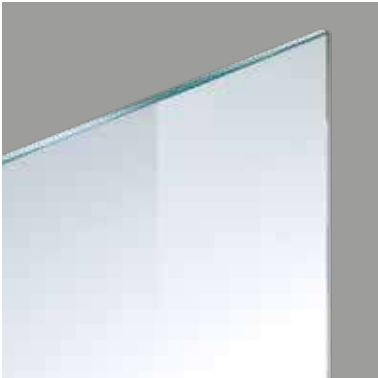

◀ Spessore vetro 8 mm



◀ Cerniere in metallo cromato con sollevamento dell'anta



Tutta l'eccellenza dei cristalli Novellini in otto millimetri di spessore. La novità di Young Plus è nel suo vetro temprato, reso sempre più stabile e sicuro. La trasparenza ben si abbina ai profili in alluminio, ora accessorati con una comoda chiusura a magnete. Una scelta di qualità per un ambiente bagno dal tono deciso.

## TRATTAMENTI







# YOUNG PLUS

# YOUNG PLUS 1B



PORTA DOCCIA APERTURA 1 ANTA BATTENTE, IN NICCHIA

Misure			Codice	Scelta vetro		Scelta profilo				
Misura effettiva d'ingombro	Entrata (cm)	Ingombro anta esterno		1	44	U	B	K	H	Z
<b>A1</b>	*	<b>B</b>		Trasparente	Band Satin	Bianco opaco	Silver	Cromo	Nero opaco	Inox spazzolato
77↔81	68	69	<b>YPLUS1B77-</b>			680 €	750 €	827 €	827 €	992 €
82↔86	73	74	<b>YPLUS1B82-</b>			695 €	764 €	842 €	842 €	1.010 €
87↔91	78	79	<b>YPLUS1B87-</b>		+ 38 €	708 €	780 €	857 €	857 €	1.028 €
92↔96	83	84	<b>YPLUS1B92-</b>			722 €	794 €	874 €	874 €	1.049 €
97↔101	88	89	<b>YPLUS1B97-</b>			735 €	808 €	889 €	889 €	1.067 €
H 140↓220 L 60↔120	SPECIAL		<b>YPLUS1BSP</b>	-		933 €	1.027 €	1.130 €	1.130 €	1.356 €

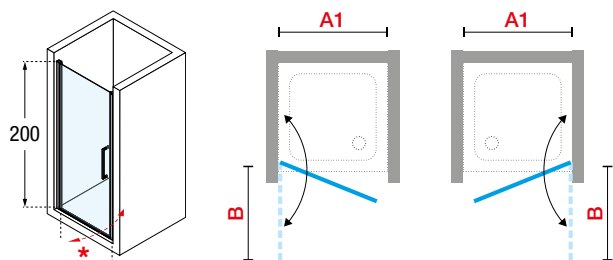

## OPTIONAL



**GUARNIZIONE INFERIORE ORIZZONTALE**  
PER MONTAGGIO SENZA PROFILO INFERIORE DI TENUTA 100 CM

<b>Codice</b>	<b>Prezzo</b>
<b>R55SPB8M01-TR</b>	43 €





**FINITURE VETRI**



Trasparente  
cod 1



Band Satin  
cod 44

**FINITURE PROFILI**



Bianco opaco  
cod U

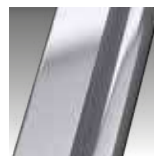

Silver  
cod B



Cromo  
cod K



Nero opaco  
cod H



Inox spazzolato  
cod Z

# YOUNG PLUS G+F IN LINEA



PORTA DOCCIA APERTURA 1 ANTA BATTENTE E 1 FISSO IN LINEA, IN NICCHIA

Misure				Codice	Destra	Sinistra	Scelta vetro		Scelta profilo				
Misura effettiva d'ingombro	Fisso in linea	Entrata (cm)	Ingombro anta esterno		D-	S-	1	44	U	B	K	H	Z
A	F1	*	B				Trasparente	Band Satin	Bianco opaco	Silver	Cromo	Nero opaco	Inox spazzolato

PORTA REVERSIBILE													
97-101	33	58	59	<b>YPLUSGFL97-</b>					790 €	854 €	923 €	923 €	1.107 €
103-107	33	64	65	<b>YPLUSGFL103-</b>					834 €	918 €	1.010 €	1.010 €	1.212 €
107↔111	33	68	69	<b>YPLUSGFL107-</b>					834 €	918 €	1.010 €	1.010 €	1.212 €
114↔118	40	68	69	<b>YPLUSGFL114-</b>					853 €	939 €	1.034 €	1.034 €	1.241 €
117↔121	43	68	69	<b>YPLUSGFL117-</b>					853 €	939 €	1.034 €	1.034 €	1.241 €
134↔138	50	78	79	<b>YPLUSGFL134-</b>					905 €	997 €	1.097 €	1.097 €	1.316 €
137↔141	53	78	79	<b>YPLUSGFL137-</b>	-	-		-	957 €	1.052 €	1.158 €	1.158 €	1.389 €
147↔151	63	78	79	<b>YPLUSGFL147-</b>					982 €	1.082 €	1.190 €	1.190 €	1.428 €
154↔158	70	78	79	<b>YPLUSGFL154-</b>					997 €	1.097 €	1.209 €	1.209 €	1.451 €
157↔161	63	88	89	<b>YPLUSGFL157-</b>					1.012 €	1.113 €	1.225 €	1.225 €	1.470 €
164↔168	70	88	89	<b>YPLUSGFL164-</b>					1.019 €	1.122 €	1.233 €	1.233 €	1.479 €
167↔171	73	88	89	<b>YPLUSGFL167-</b>					1.025 €	1.128 €	1.242 €	1.242 €	1.490 €
177↔181	83	88	89	<b>YPLUSGFL177-</b>					1.039 €	1.142 €	1.258 €	1.258 €	1.509 €
H 140↔220 L 70↔200			SPECIAL	<b>YPLUSGFLSP</b>	-	-		-	1.439 €	1.583 €	1.742 €	1.742 €	2.090 €

PORTA NON REVERSIBILE													
					D-	S-		44	U	B	K	H	Z
97-101	33	58	59	<b>YPLUSGFL97</b>	D-	S-			790 €	854 €	923 €	923 €	1.107 €
103-107	33	64	65	<b>YPLUSGFL103</b>	D-	S-			834 €	918 €	1.010 €	1.010 €	1.212 €
107↔111	33	68	69	<b>YPLUSGFL107</b>	D-	S-			834 €	918 €	1.010 €	1.010 €	1.212 €
114↔118	40	68	69	<b>YPLUSGFL114</b>	D-	S-			853 €	939 €	1.034 €	1.034 €	1.241 €
117↔121	43	68	69	<b>YPLUSGFL117</b>	D-	S-			853 €	939 €	1.034 €	1.034 €	1.241 €
134↔138	50	78	79	<b>YPLUSGFL134</b>	D-	S-			905 €	997 €	1.097 €	1.097 €	1.316 €
137↔141	53	78	79	<b>YPLUSGFL137</b>	D-	S-	-	+ 38 €	957 €	1.052 €	1.158 €	1.158 €	1.389 €
147↔151	63	78	79	<b>YPLUSGFL147</b>	D-	S-			982 €	1.082 €	1.190 €	1.190 €	1.428 €
154↔158	70	78	79	<b>YPLUSGFL154</b>	D-	S-			997 €	1.097 €	1.209 €	1.209 €	1.451 €
157↔161	63	88	89	<b>YPLUSGFL157</b>	D-	S-			1.012 €	1.113 €	1.225 €	1.225 €	1.470 €
164↔168	70	88	89	<b>YPLUSGFL164</b>	D-	S-			1.019 €	1.122 €	1.233 €	1.233 €	1.479 €
167↔171	73	88	89	<b>YPLUSGFL167</b>	D-	S-			1.025 €	1.128 €	1.242 €	1.242 €	1.490 €
177↔181	83	88	89	<b>YPLUSGFL177</b>	D-	S-			1.039 €	1.142 €	1.258 €	1.258 €	1.509 €

## BARRA DI SOSTEGNO 100 CM IN SERIE

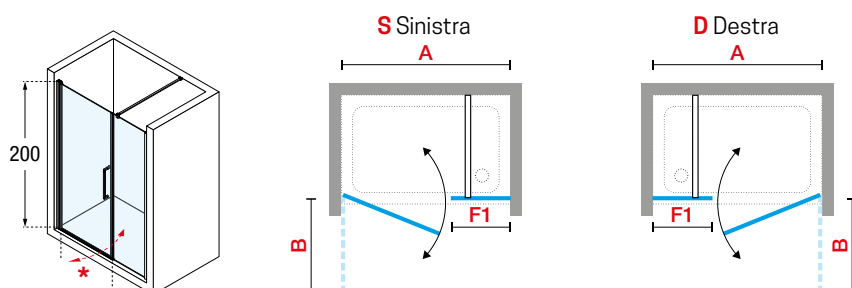

### OPTIONAL



**GUARNIZIONE INFERIORE ORIZZONTALE**  
PER MONTAGGIO SENZA PROFILO INFERIORE DI TENUTA 100 CM

Codice	Prezzo
<b>R55SPB8A01-TR</b>	43 €





**FINITURE VETRI**



Trasparente  
cod 1



Band Satin  
cod 44

**FINITURE PROFILI**



Bianco opaco  
cod U

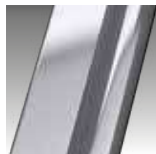

Silver  
cod B



Cromo  
cod K



Nero opaco  
cod H



Inox spazzolato  
cod Z

# YOUNG PLUS G+F



## BOX DOCCIA AD ANGOLO APERTURA 1 ANTA BATTENTE CON PARETE FISSA LATERALE

Misure				Codice	Destra	Sinistra	Scelta vetro		Scelta profilo				
Misura effettiva d'ingombro	Misura centro lastra	Entrata (cm)	Ingombro anta esterno		D-	S-	1	44	U	B	K	H	Z
A	G	*	B				Trasparente	Band Satin	Bianco opaco	Silver	Cromo	Nero opaco	Inox spazzolato
<b>PORTA REVERSIBILE</b>													
76↔78	74,4↔76,4	67	68	<b>YPLUSG76-</b>					533 €	587 €	648 €	648 €	777 €
77↔79	75,4↔77,4	68	69	<b>YPLUSG77-</b>					562 €	617 €	678 €	678 €	813 €
79↔81	77,4↔79,4	70	71	<b>YPLUSG79-</b>					562 €	617 €	678 €	678 €	813 €
81↔83	79,4↔81,4	72	73	<b>YPLUSG81-</b>					562 €	617 €	678 €	678 €	813 €
83↔85	81,4↔83,4	74	75	<b>YPLUSG83-</b>					562 €	617 €	678 €	678 €	813 €
85↔87	83,4↔85,4	76	77	<b>YPLUSG85-</b>					562 €	617 €	678 €	678 €	813 €
87↔89	85,4↔87,4	78	79	<b>YPLUSG87-</b>					562 €	617 €	678 €	678 €	813 €
89↔91	87,4↔89,4	80	81	<b>YPLUSG89-</b>	-	-		+ 38 €	585 €	647 €	710 €	710 €	852 €
91↔93	89,4↔91,4	82	83	<b>YPLUSG91-</b>					585 €	647 €	710 €	710 €	852 €
93↔95	91,4↔93,4	84	85	<b>YPLUSG93-</b>					585 €	647 €	710 €	710 €	852 €
95↔97	93,4↔95,4	86	87	<b>YPLUSG95-</b>					585 €	647 €	710 €	710 €	852 €
97↔99	95,4↔97,4	88	89	<b>YPLUSG97-</b>					585 €	647 €	710 €	710 €	852 €
99↔101	97,4↔99,4	90	91	<b>YPLUSG99-</b>					614 €	675 €	745 €	745 €	894 €
101↔103	99,4↔101,4	92	93	<b>YPLUSG101-</b>					614 €	675 €	745 €	745 €	894 €
103↔105	101,4↔103,4	94	95	<b>YPLUSG103-</b>					614 €	675 €	745 €	745 €	894 €
H 140↔220			SPECIAL	<b>YPLUSGSP</b>	-	-			764 €	842 €	927 €	927 €	1.112 €
L 60↔120													
<b>FISSO REVERSIBILE</b>													
<b>F</b>							<b>1</b>		<b>U</b>	<b>B</b>	<b>K</b>	<b>H</b>	<b>Z</b>
67↔69	65,4↔67,4			<b>YPLUSFG67-</b>					497 €	535 €	580 €	580 €	696 €
69↔71	67,4↔69,4			<b>YPLUSFG69-</b>					497 €	535 €	580 €	580 €	696 €
76↔78	74,4↔76,4			<b>YPLUSFG76-</b>					510 €	563 €	618 €	618 €	741 €
77↔79	75,4↔77,4			<b>YPLUSFG77-</b>					510 €	563 €	618 €	618 €	741 €
79↔81	77,4↔79,4			<b>YPLUSFG79-</b>					510 €	563 €	618 €	618 €	741 €
81↔83	79,4↔81,4			<b>YPLUSFG81-</b>					510 €	563 €	618 €	618 €	741 €
83↔85	81,4↔83,4			<b>YPLUSFG83-</b>					539 €	593 €	654 €	654 €	785 €
85↔87	83,4↔85,4			<b>YPLUSFG85-</b>					539 €	593 €	654 €	654 €	785 €
87↔89	85,4↔87,4			<b>YPLUSFG87-</b>					539 €	593 €	654 €	654 €	785 €
89↔91	87,4↔89,4			<b>YPLUSFG89-</b>	-	-			539 €	593 €	654 €	654 €	785 €
91↔93	89,4↔91,4			<b>YPLUSFG91-</b>					539 €	593 €	654 €	654 €	785 €
93↔95	91,4↔93,4			<b>YPLUSFG93-</b>					539 €	593 €	654 €	654 €	785 €
95↔97	93,4↔95,4			<b>YPLUSFG95-</b>					539 €	593 €	654 €	654 €	785 €
97↔99	95,4↔97,4			<b>YPLUSFG97-</b>					570 €	627 €	693 €	693 €	831 €
99↔101	97,4↔99,4			<b>YPLUSFG99-</b>					570 €	627 €	693 €	693 €	831 €
101↔103	99,4↔101,4			<b>YPLUSFG101-</b>					570 €	627 €	693 €	693 €	831 €
103↔105	101,4↔103,4			<b>YPLUSFG103-</b>					570 €	627 €	693 €	693 €	831 €
117↔119	115,4↔117,4			<b>YPLUSFG117-</b>					602 €	650 €	703 €	703 €	843 €
119↔121	117,4↔119,4			<b>YPLUSFG119-</b>					602 €	650 €	703 €	703 €	843 €
H 140↔220			SPECIAL	<b>YPLUSFGSP</b>					742 €	819 €	902 €	902 €	1.082 €
L 20↔120													
<b>FISSO NON REVERSIBILE</b>													
<b>F</b>								<b>44</b>	<b>U</b>	<b>B</b>	<b>K</b>	<b>H</b>	<b>Z</b>
67↔69	65,4↔67,4			<b>YPLUSFG67</b>	D-	S-			497 €	535 €	580 €	580 €	696 €
69↔71	67,4↔69,4			<b>YPLUSFG69</b>	D-	S-			497 €	535 €	580 €	580 €	696 €
76↔78	74,4↔76,4			<b>YPLUSFG76</b>	D-	S-			510 €	563 €	618 €	618 €	741 €
77↔79	75,4↔77,4			<b>YPLUSFG77</b>	D-	S-			510 €	563 €	618 €	618 €	741 €
79↔81	77,4↔79,4			<b>YPLUSFG79</b>	D-	S-			510 €	563 €	618 €	618 €	741 €
81↔83	79,4↔81,4			<b>YPLUSFG81</b>	D-	S-			510 €	563 €	618 €	618 €	741 €
83↔85	81,4↔83,4			<b>YPLUSFG83</b>	D-	S-			539 €	593 €	654 €	654 €	785 €
85↔87	83,4↔85,4			<b>YPLUSFG85</b>	D-	S-			539 €	593 €	654 €	654 €	785 €
87↔89	85,4↔87,4			<b>YPLUSFG87</b>	D-	S-			539 €	593 €	654 €	654 €	785 €
89↔91	87,4↔89,4			<b>YPLUSFG89</b>	D-	S-		+ 38 €	539 €	593 €	654 €	654 €	785 €
91↔93	89,4↔91,4			<b>YPLUSFG91</b>	D-	S-			539 €	593 €	654 €	654 €	785 €
93↔95	91,4↔93,4			<b>YPLUSFG93</b>	D-	S-			539 €	593 €	654 €	654 €	785 €
95↔97	93,4↔95,4			<b>YPLUSFG95</b>	D-	S-			539 €	593 €	654 €	654 €	785 €
97↔99	95,4↔97,4			<b>YPLUSFG97</b>	D-	S-			570 €	627 €	693 €	693 €	831 €
99↔101	97,4↔99,4			<b>YPLUSFG99</b>	D-	S-			570 €	627 €	693 €	693 €	831 €
101↔103	99,4↔101,4			<b>YPLUSFG101</b>	D-	S-			570 €	627 €	693 €	693 €	831 €
103↔105	101,4↔103,4			<b>YPLUSFG103</b>	D-	S-			570 €	627 €	693 €	693 €	831 €
117↔119	115,4↔117,4			<b>YPLUSFG117</b>	D-	S-			602 €	650 €	703 €	703 €	843 €
119↔121	117,4↔119,4			<b>YPLUSFG119</b>	D-	S-			602 €	650 €	703 €	703 €	843 €

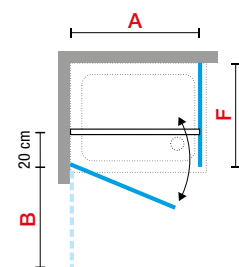
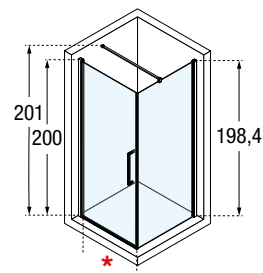

**BARRA DI SOSTEGNO 150 CM IN DOTAZIONE**

### OPTIONAL



#### GUARNIZIONE INFERIORE ORIZZONTALE

PER MONTAGGIO SENZA PROFILO INFERIORE DI TENUTA 100 CM

Codice	Prezzo
<b>R55SPB8M01-TR</b>	43 €

**A** Misura effettiva d'ingombro

**G** Misura centro lastra

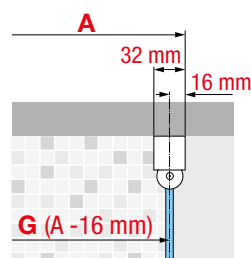



**FINITURE VETRI**



Trasparente  
cod 1



Band Satin  
cod 44

**FINITURE PROFILI**



Bianco opaco  
cod U

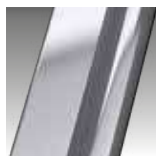

Silver  
cod B



Cromo  
cod K



Nero opaco  
cod H



Inox spazzolato  
cod Z

# YOUNG PLUS 2G



## BOX DOCCIA AD ANGOLO APERTURA 2 ANTE BATTENTI

Misure				Codice	Scelta vetro		Scelta profilo				
Misura effettiva d'ingombro	Misura centro lastra	Entrata (cm)	Ingombro anta esterno		1	44	U	B	K	H	Z
<b>A</b>	<b>G</b>	<b>*</b>	<b>B</b>		Trasparente	Band Satin	Bianco opaco	Silver	Cromo	Nero opaco	Inox spazzolato
76↔78	74,4↔76,4	96	68	<b>YPLUS2G76L-</b>			533 €	587 €	648 €	648 €	777 €
77↔79	75,4↔77,4	97	69	<b>YPLUS2G77L-</b>			562 €	617 €	678 €	678 €	813 €
79↔81	77,4↔79,4	100	71	<b>YPLUS2G79L-</b>			562 €	617 €	678 €	678 €	813 €
81↔83	79,4↔81,4	103	73	<b>YPLUS2G81L-</b>			562 €	617 €	678 €	678 €	813 €
83↔85	81,4↔83,4	106	75	<b>YPLUS2G83L-</b>			562 €	617 €	678 €	678 €	813 €
85↔87	83,4↔85,4	108	77	<b>YPLUS2G85L-</b>			562 €	617 €	678 €	678 €	813 €
87↔89	85,4↔87,4	111	79	<b>YPLUS2G87L-</b>			585 €	647 €	710 €	710 €	813 €
89↔91	87,4↔89,4	114	81	<b>YPLUS2G89L-</b>	+ 38 €		585 €	647 €	710 €	710 €	852 €
91↔93	89,4↔91,4	117	83	<b>YPLUS2G91L-</b>			585 €	647 €	710 €	710 €	852 €
93↔95	91,4↔93,4	120	85	<b>YPLUS2G93L-</b>			585 €	647 €	710 €	710 €	852 €
95↔97	93,4↔95,4	123	87	<b>YPLUS2G95L-</b>			585 €	647 €	710 €	710 €	852 €
97↔99	95,4↔97,4	125	89	<b>YPLUS2G97L-</b>			614 €	675 €	745 €	745 €	852 €
99↔101	97,4↔99,4	128	91	<b>YPLUS2G99L-</b>			614 €	675 €	745 €	745 €	894 €
101↔103	99,4↔101,4	131	93	<b>YPLUS2G101L-</b>			614 €	675 €	745 €	745 €	894 €
103↔105	101,4↔103,4	134	95	<b>YPLUS2G103L-</b>			614 €	675 €	745 €	745 €	894 €
H 140↔220 L 60↔120		SPECIAL		<b>YPLUS2GLSP</b>	-		764 €	842 €	927 €	927 €	1.112 €

### PER COMPORRE UN ANGOLO ORDINARE 2 LATI

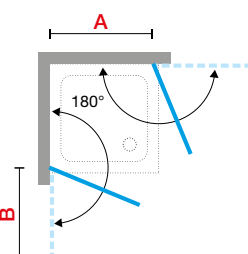
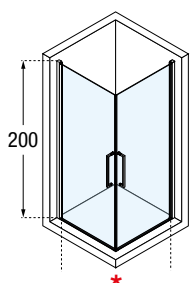

#### OPTIONAL

**GUARNIZIONE INFERIORE ORIZZONTALE**  
PER MONTAGGIO SENZA PROFILO INFERIORE DI TENUTA 100 CM

Codice	Prezzo
<b>R55SPB8A01-TR</b>	43 €

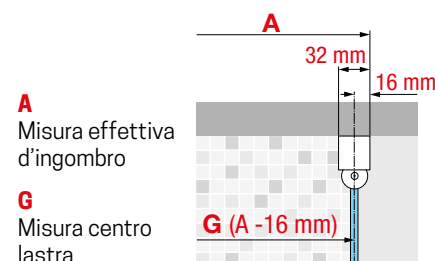

030

Costruzione del codice

**Codice**

+

**Vetro**

+

**Profilo**

= Codice prodotto finale





**FINITURE VETRI**



Trasparente  
cod 1



Band Satin  
cod 44

**FINITURE PROFILI**



Bianco opaco  
cod U

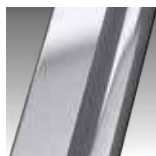

Silver  
cod B



Cromo  
cod K



Nero opaco  
cod H



Inox spazzolato  
cod Z

OPTIONAL



**BARRA DI SOSTEGNO AD ANGOLO**

Finitura	Misure	Codice	Prezzo
Bianco opaco	25 cm	<b>R80LOU250-U</b>	72 €
Cromo		<b>R80LOU250-K</b>	72 €
Nero opaco		<b>R80LOU250-H</b>	72 €
Inox sp.		<b>R80LOU250-Z</b>	87 €
Bianco opaco	35 cm	<b>R80LOU350-U</b>	78 €
Cromo		<b>R80LOU350-K</b>	78 €
Nero opaco		<b>R80LOU350-H</b>	78 €
Inox sp.		<b>R80LOU350-Z</b>	94 €
Bianco opaco	45 cm	<b>R80LOU450-U</b>	85 €
Cromo		<b>R80LOU450-K</b>	85 €
Nero opaco		<b>R80LOU450-H</b>	85 €
Inox sp.		<b>R80LOU450-Z</b>	102 €



**BARRA DI SOSTEGNO 200 cm (accorciabile)**

Finitura	Codice	Prezzo
Bianco opaco	<b>R80Y220-U</b>	69 €
Silver	<b>R80Y220-B</b>	75 €
Cromo	<b>R80Y220-K</b>	82 €
Nero opaco	<b>R80Y220-H</b>	82 €
Inox sp.	<b>R80Y220-Z</b>	99 €



**KIT BARRA ORIENTABILE**

- 1 barra orientabile da 100 cm (accorciabile)
- 1 attacco a muro
- 1 morsetto di fissaggio al vetro

Finitura	Misure	Codice	Prezzo
Bianco opaco	100 cm	<b>R80KUOR100-U</b>	105 €
Silver		<b>R80KUOR100-B</b>	117 €
Cromo		<b>R80KUOR100-K</b>	127 €
Nero opaco		<b>R80KUOR100-H</b>	127 €
Inox sp.		<b>R80KUOR100-Z</b>	153 €



**KIT BARRA A "T" (accorciabile)**

barra di sostegno 150 cm da abbinare con la barra in dotazione per soluzione a "T"

Finitura	Codice	Prezzo
Bianco opaco	<b>R80Y215T-U</b>	90 €
Silver	<b>R80Y215T-B</b>	98 €
Cromo	<b>R80Y215T-K</b>	108 €
Nero opaco	<b>R80Y215T-H</b>	108 €
Inox sp.	<b>R80Y215T-Z</b>	131 €



**GUARNIZIONE INFERIORE ORIZZONTALE - L. 100 cm**

PER MONTAGGIO SENZA PROFILO INFERIORE DI TENUTA

PER YOUNG PLUS 1B / G+F

Codice	Prezzo
<b>R55SPB8M01-TR</b>	43 €

PER YOUNG PLUS G+F in linea / 2G

Codice	Prezzo
<b>R55SPB8A01-TR</b>	43 €

## DATI TECNICI

### FINITURE PROFILI



Bianco opaco  
cod. U

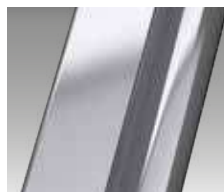

Silver  
cod. B



Cromo  
cod. K 



Nero opaco  
cod. H



Inox spazzolato  
cod. Z

### VETRO TEMPRATO 8 mm (European Standards EN 14428)



Trasparente   
cod. 1



Band Satin  
cod. 44

### OPTIONAL



Maniglia cromata

Finitura	Codice	Prezzo
Cromo	<b>R40EIMAY21-K</b>	88 €
Nero	<b>R40EIMAY21-H</b>	88 €

### MISURE DI INGOMBRO PROFILI DI FISSAGGIO

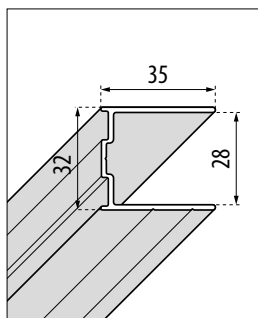

#### A MURO

Altezza	Finitura	Codice
1984	Bianco opaco	<b>P01BNMOBST-U</b>
	Silver	<b>P01BNMOBST-B</b>
	Cromo	<b>P01BNMOBST-K</b>
	Nero	<b>P01BNMOBST-H</b>
	Inox Sp.	<b>P01BNMOBST-Z</b>
2000	Bianco opaco	<b>P01BNMOAST-U</b>
	Silver	<b>P01BNMOAST-B</b>
	Cromo	<b>P01BNMOAST-K</b>
	Nero	<b>P01BNMOAST-H</b>
	Inox Sp.	<b>P01BNMOAST-Z</b>

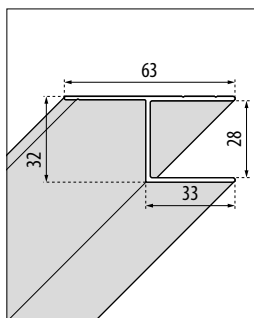

#### A MURO (OPTIONAL)

fissaggio a muro laterale

Altezza	Finitura	Codice
1984	Bianco opaco	<b>P01Y2MOBSTL-U</b>
	Silver	<b>P01Y2MOBSTL-B</b>
	Cromo	<b>P01Y2MOBSTL-K</b>
	Nero	<b>P01Y2MOBSTL-H</b>
	Inox Sp.	<b>P01Y2MOBSTL-Z</b>
2000	Bianco opaco	<b>P01Y2MOASTL-U</b>
	Silver	<b>P01Y2MOASTL-B</b>
	Cromo	<b>P01Y2MOASTL-K</b>
	Nero	<b>P01Y2MOASTL-H</b>
	Inox Sp.	<b>P01Y2MOASTL-Z</b>

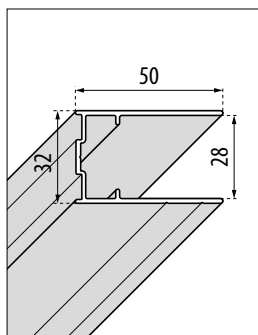

#### COMPENSATIVI (OPTIONAL)

in sostituzione del profilo a muro +15 mm

Altezza	Finitura	Codice
1984	Bianco opaco	<b>P05Y2ST-U</b>
	Silver	<b>P05Y2ST-B</b>
	Cromo	<b>P05Y2ST-K</b>
	Nero	<b>P05Y2ST-H</b>
	Inox Sp.	<b>P05Y2ST-Z</b>
2000	Bianco opaco	<b>P05Y2ST2-U</b>
	Silver	<b>P05Y2ST2-B</b>
	Cromo	<b>P05Y2ST2-K</b>
	Nero	<b>P05Y2ST2-H</b>
	Inox Sp.	<b>P05Y2ST2-Z</b>

### COME RILEVARE LE MISURE

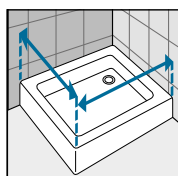

Rilevare le misure da muro a bordo esterno del piatto doccia. Le misure devono essere rilevate sulla parete finita, a rivestimenti posati, secondo gli schemi riportati.

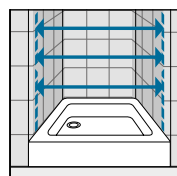

Rilevare le misure da muro a muro, in basso, in alto, al centro e utilizzare quella di valore inferiore. Le misure devono essere rilevate sulla parete finita, a rivestimenti posati, secondo gli schemi riportati.

# YOUNG

ESSENZIALE, VERSATILE, FACILE.



◀ Maniglia in acciaio inox



◀ Possibilità di apertura interno/esterno



◀ Cerniere in metallo cromato con sollevamento dell'anta



Il box doccia che interpreta le esigenze estetiche e funzionali dell'ambiente bagno con linearità.

Estremamente adattabile grazie alle sue molteplici configurazioni ad angolo o in nicchia, permette di valorizzare i volumi secondo le possibilità a disposizione, massimizzando gli spazi anche quando scarseggiano. Le ante possono essere battenti o a soffietto e abbinabili a parete fissa; il sistema di sollevamento dell'anta in apertura e chiusura assicura pulizia e manutenzioni semplici.

## TRATTAMENTI





# YOUNG

# YOUNG 1B



## PORTA DOCCIA APERTURA 1 ANTA BATTENTE

Installabile in nicchia o abbinabile a parete fissa laterale YOUNG 2.0 F1B

Misure						Codice	Scelta vetro			Scelta profilo				
Misura effettiva d'ingombro con fisso	Misura centro lastra	In nicchia	Fisso laterale	Entrata (cm)	Ingombro anta esterno		1	2	4	U	B	K	H	
A	G	A1	F	*	B		Trasparente	Aqua	Satin	Bianco opaco	Silver	Cromo	Nero opaco	
<b>PORTA</b>														
58↔62	56,4↔60,4	57↔61		47	48	<b>Y21B57-</b>	●				524 €	578 €	635 €	635 €
68↔72	66,4↔70,4	67↔71		57	58	<b>Y21B67-</b>	●				545 €	599 €	660 €	660 €
73↔77	71,4↔75,4	72↔76		62	63	<b>Y21B72-</b>					545 €	599 €	660 €	660 €
78↔82	76,4↔80,4	77↔81		67	68	<b>Y21B77-</b>	●				568 €	625 €	689 €	689 €
80↔84	78,4↔82,4	79↔83		69	70	<b>Y21B79-</b>		+ 38 €	+ 38 €		579 €	637 €	702 €	702 €
83↔87	81,4↔85,4	82↔86		72	73	<b>Y21B82-</b>					579 €	637 €	702 €	702 €
88↔92	86,4↔90,4	87↔91		77	78	<b>Y21B87-</b>	●				589 €	650 €	714 €	714 €
93↔97	91,4↔95,4	92↔96		82	83	<b>Y21B92-</b>					600 €	662 €	728 €	728 €
98↔102	96,4↔100,4	97↔101		87	88	<b>Y21B97-</b>	●				613 €	673 €	742 €	742 €
H 140↔220						SPECIAL <b>Y21BSP</b>		+ 38 €	+ 38 €		778 €	855 €	942 €	942 €
L 54↔120														
<b>PARETE FISSA</b>														
-	55,4↔57,4	-	57↔59	-	-	<b>Y2F1B57-</b>					375 €	414 €	455 €	455 €
-	57,4↔59,4	-	59↔61	-	-	<b>Y2F1B59-</b>					375 €	414 €	455 €	455 €
-	63,4↔65,4	-	65↔67	-	-	<b>Y2F1B65-</b>					400 €	440 €	484 €	484 €
-	65,4↔67,4	-	67↔69	-	-	<b>Y2F1B67-</b>	●				400 €	440 €	484 €	484 €
-	67,4↔69,4	-	69↔71	-	-	<b>Y2F1B69-</b>					400 €	440 €	484 €	484 €
-	71,4↔73,4	-	73↔75	-	-	<b>Y2F1B73-</b>					425 €	468 €	514 €	514 €
-	73,4↔75,4	-	75↔77	-	-	<b>Y2F1B75-</b>					425 €	468 €	514 €	514 €
-	74,4↔76,4	-	76↔78	-	-	<b>Y2F1B76-</b>					425 €	468 €	514 €	514 €
-	75,4↔77,4	-	77↔79	-	-	<b>Y2F1B77-</b>	●				425 €	468 €	514 €	514 €
-	77,4↔79,4	-	79↔81	-	-	<b>Y2F1B79-</b>					425 €	468 €	514 €	514 €
-	79,4↔81,4	-	81↔83	-	-	<b>Y2F1B81-</b>		+ 38 €	+ 38 €		425 €	468 €	514 €	514 €
-	83,4↔85,4	-	85↔87	-	-	<b>Y2F1B85-</b>					449 €	494 €	544 €	544 €
-	85,4↔87,4	-	87↔89	-	-	<b>Y2F1B87-</b>	●				449 €	494 €	544 €	544 €
-	87,4↔89,4	-	89↔91	-	-	<b>Y2F1B89-</b>	●				449 €	494 €	544 €	544 €
-	89,4↔91,4	-	91↔93	-	-	<b>Y2F1B91-</b>					449 €	494 €	544 €	544 €
-	93,4↔95,4	-	95↔97	-	-	<b>Y2F1B95-</b>					449 €	494 €	544 €	544 €
-	95,4↔97,4	-	97↔99	-	-	<b>Y2F1B97-</b>	●				475 €	523 €	577 €	577 €
-	97,4↔99,4	-	99↔101	-	-	<b>Y2F1B99-</b>					475 €	523 €	577 €	577 €
-	99,4↔101,4	-	101↔103	-	-	<b>Y2F1B101-</b>					475 €	523 €	577 €	577 €
-	115,4↔117,4	-	117↔119	-	-	<b>Y2F1B117-</b>					475 €	523 €	577 €	577 €
-	117,4↔119,4	-	119↔121	-	-	<b>Y2F1B119-</b>					475 €	523 €	577 €	577 €
			H 140↔220			SPECIAL <b>Y2F1BSP</b>		+ 38 €	+ 38 €		589 €	649 €	714 €	714 €
			L 20↔120											

**IL FISSO SPECIALE DEVE ESSERE ORDINATO DELLA STESSA ALTEZZA TOTALE DELLA PORTA BARRA DI SOSTEGNO 150 CM IN DOTAZIONE**

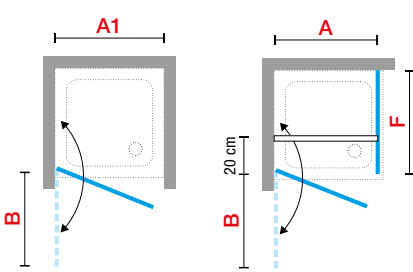
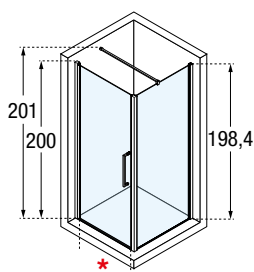

### OPTIONAL

**GUARNIZIONE INFERIORE ORIZZONTALE**  
PER MONTAGGIO SENZA PROFILO INFERIORE DI TENUTA, 100 CM

Codice	Prezzo
<b>R55SPBOM01-TR</b>	43 €

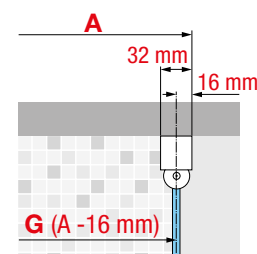



**FINITURE VETRI**



Trasparente  
cod 1



Aqua  
cod 2

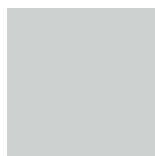

Satin  
cod 4

**FINITURE PROFILI**



Bianco opaco  
cod U

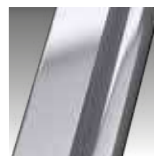

Silver  
cod B



Cromo  
cod K



Nero opaco  
cod H

# YOUNG G+F IN LINEA



## PORTA DOCCIA APERTURA 1 ANTA BATTENTE E 1 FISSO IN LINEA

Installabile in nicchia o abbinabile a parete fissa laterale YOUNG 2.0 F1B

Misure						Codice	Scelta vetro			Scelta profilo				
Misura effettiva d'ingombro con fisso	Misura centro lastra	In nicchia	Fisso in linea	Entrata (cm)	Ingombro anta esterno		1	2	4	U	B	K	H	
<b>A</b>	<b>G</b>	<b>A1</b>	<b>F1</b>	*	<b>B</b>		Trasparente	Aqua	Satin	Bianco opaco	Silver	Cromo	Nero opaco	
<b>PORTA</b>														
98↔102	96,4↔100,4	97↔101	32,5	58	59	<b>Y2GFL97-</b>	●				677 €	745 €	820 €	820 €
108↔112	106,4↔110,4	107↔111	42,5	58	59	<b>Y2GFL107-</b>	●				695 €	764 €	842 €	842 €
115↔119	113,4↔117,4	114↔118	39,5	68	69	<b>Y2GFL114-</b>	●				710 €	783 €	862 €	862 €
118↔122	116,4↔120,4	117↔121	42,5	68	69	<b>Y2GFL117-</b>	●				710 €	783 €	862 €	862 €
135↔139	133,4↔137,4	134↔138	49,5	78	79	<b>Y2GFL134-</b>	●				754 €	830 €	914 €	914 €
138↔142	136,4↔140,4	137↔141	52,5	78	79	<b>Y2GFL137-</b>	●	+ 38 €	+ 38 €		797 €	877 €	965 €	965 €
148↔152	146,4↔150,4	147↔151	52,5	88	89	<b>Y2GFL147-</b>	●				819 €	900 €	993 €	993 €
155↔159	153,4↔157,4	154↔158	59,5	88	89	<b>Y2GFL154-</b>	●				830 €	914 €	1.007 €	1.007 €
158↔162	156,4↔160,4	157↔161	62,5	88	89	<b>Y2GFL157-</b>	●				843 €	928 €	1.020 €	1.020 €
165↔169	163,4↔167,4	164↔168	69,5	88	89	<b>Y2GFL164-</b>	●				849 €	934 €	1.027 €	1.027 €
168↔172	166,4↔170,4	167↔171	72,5	88	89	<b>Y2GFL167-</b>	●				854 €	939 €	1.035 €	1.035 €
178↔182	176,4↔180,4	177↔181	82,5	88	89	<b>Y2GFL177-</b>	●				865 €	952 €	1.048 €	1.048 €
H 140↔220 L 97↔177					SPECIAL	<b>Y2GFLSP</b>		+ 38 €	+ 38 €		1.199 €	1.319 €	1.452 €	1.452 €
<b>PARETE FISSA</b>														
<b>F</b>														
57↔59	55,4↔57,4	-	-	-	-	<b>Y2F1B57-</b>					375 €	414 €	455 €	455 €
59↔61	57,4↔59,4	-	-	-	-	<b>Y2F1B59-</b>					375 €	414 €	455 €	455 €
65↔67	63,4↔65,4	-	-	-	-	<b>Y2F1B65-</b>					400 €	440 €	484 €	484 €
67↔69	65,4↔67,4	-	-	-	-	<b>Y2F1B67-</b>	●				400 €	440 €	484 €	484 €
69↔71	67,4↔69,4	-	-	-	-	<b>Y2F1B69-</b>	●				400 €	440 €	484 €	484 €
73↔75	71,4↔73,4	-	-	-	-	<b>Y2F1B73-</b>					425 €	468 €	514 €	514 €
75↔77	73,4↔75,4	-	-	-	-	<b>Y2F1B75-</b>					425 €	468 €	514 €	514 €
76↔78	74,4↔76,4	-	-	-	-	<b>Y2F1B76-</b>					425 €	468 €	514 €	514 €
77↔79	75,4↔77,4	-	-	-	-	<b>Y2F1B77-</b>	●				425 €	468 €	514 €	514 €
79↔81	77,4↔79,4	-	-	-	-	<b>Y2F1B79-</b>	●				425 €	468 €	514 €	514 €
81↔83	79,4↔81,4	-	-	-	-	<b>Y2F1B81-</b>		+ 38 €	+ 38 €		425 €	468 €	514 €	514 €
85↔87	83,4↔85,4	-	-	-	-	<b>Y2F1B85-</b>					449 €	494 €	544 €	544 €
87↔89	85,4↔87,4	-	-	-	-	<b>Y2F1B87-</b>	●				449 €	494 €	544 €	544 €
89↔91	87,4↔89,4	-	-	-	-	<b>Y2F1B89-</b>	●				449 €	494 €	544 €	544 €
91↔93	89,4↔91,4	-	-	-	-	<b>Y2F1B91-</b>	●				449 €	494 €	544 €	544 €
95↔97	93,4↔95,4	-	-	-	-	<b>Y2F1B95-</b>	●				449 €	494 €	544 €	544 €
97↔99	95,4↔97,4	-	-	-	-	<b>Y2F1B97-</b>	●				475 €	523 €	577 €	577 €
99↔101	97,4↔99,4	-	-	-	-	<b>Y2F1B99-</b>	●				475 €	523 €	577 €	577 €
101↔103	99,4↔101,4	-	-	-	-	<b>Y2F1B101-</b>	●				475 €	523 €	577 €	577 €
117↔119	115,4↔117,4	-	-	-	-	<b>Y2F1B117-</b>	●				475 €	523 €	577 €	577 €
119↔121	117,4↔119,4	-	-	-	-	<b>Y2F1B119-</b>	●				475 €	523 €	577 €	577 €
H 140↔220 L 20↔120					SPECIAL	<b>Y2F1BSP</b>		+ 38 €	+ 38 €		589 €	649 €	714 €	714 €

**IL FISSO SPECIALE DEVE ESSERE ORDINATO DELLA STESSA ALTEZZA TOTALE DELLA PORTA  
BARRA DI SOSTEGNO 150 CM IN DOTAZIONE**

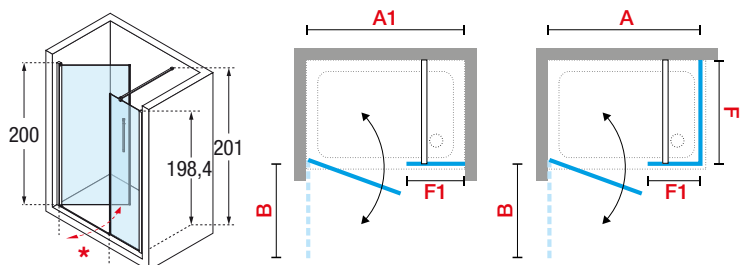

### OPTIONAL

**GUARNIZIONE INFERIORE ORIZZONTALE**  
PER MONTAGGIO SENZA PROFILO INFERIORE DI TENUTA, 100 CM

Codice	Prezzo
<b>R55SPBOM01-TR</b>	43 €

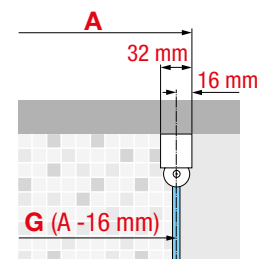





**FINITURE VETRI**



Trasparente  
cod 1



Aqua  
cod 2

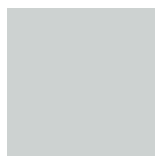

Satin  
cod 4

**FINITURE PROFILI**



Bianco opaco  
cod U

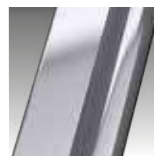

Silver  
cod B



Cromo  
cod K



Nero opaco  
cod H

# YOUNG 2B



## PORTA DOCCIA, APERTURA 2 ANTE BATTENTI

Installabile in nicchia o abbinabile a parete fissa laterale YOUNG 2.0 F2B

Misure						Codice	Scelta vetro			Scelta profilo			
Misura effettiva d'ingombro con fisso	Misura centro lastra	Misura effettiva d'ingombro	Fisso laterale	Entrata (cm)	Ingombro anta esterno		1	2	4	U	B	K	H
A	G	A1	F	*	B		Trasparente	Aqua	Satin	Bianco opaco	Silver	Cromo	Nero opaco
<b>PORTA</b>													
58↔62	56,4↔60,4	57↔61		45	23	<b>Y22B57-</b>				677 €	745 €	820 €	820 €
64↔68	62,4↔66,4	63↔67		51	26	<b>Y22B63-</b>				677 €	745 €	820 €	820 €
68↔72	66,4↔70,4	67↔71		55	28	<b>Y22B67-</b>				677 €	745 €	820 €	820 €
72↔76	70,4↔74,4	71↔75		59	30	<b>Y22B71-</b>				712 €	784 €	863 €	863 €
74↔78	72,4↔76,4	73↔77		61	31	<b>Y22B73-</b>				712 €	784 €	863 €	863 €
78↔82	76,4↔80,4	77↔81		65	33	<b>Y22B77-</b>	●			712 €	784 €	863 €	863 €
84↔88	82,4↔86,4	83↔87		71	36	<b>Y22B83-</b>				747 €	822 €	904 €	904 €
88↔92	86,4↔90,4	87↔91		75	38	<b>Y22B87-</b>	●			747 €	822 €	904 €	904 €
94↔98	92,4↔96,4	93↔97		81	41	<b>Y22B93-</b>	●			747 €	822 €	904 €	904 €
98↔102	96,4↔100,4	97↔101		85	43	<b>Y22B97-</b>	●	+ 38 €	+ 38 €	782 €	860 €	947 €	947 €
104↔108	102,4↔106,4	103↔107		91	46	<b>Y22B103-</b>				782 €	860 €	947 €	947 €
108↔112	106,4↔110,4	107↔111		95	48	<b>Y22B107-</b>				782 €	860 €	947 €	947 €
114↔118	112,4↔116,4	113↔117		101	51	<b>Y22B113-</b>				814 €	895 €	985 €	985 €
118↔122	116,4↔120,4	117↔121		105	53	<b>Y22B117-</b>	●			814 €	895 €	985 €	985 €
138↔142	136,4↔140,4	137↔141		125	63	<b>Y22B137-</b>				854 €	939 €	1.035 €	1.035 €
148↔152	146,4↔150,4	147↔151		135	68	<b>Y22B147-</b>				889 €	978 €	1.078 €	1.078 €
158↔162	156,4↔160,4	157↔161		145	73	<b>Y22B157-</b>				889 €	978 €	1.078 €	1.078 €
168↔172	166,4↔170,4	167↔171		155	78	<b>Y22B167-</b>				924 €	1.017 €	1.120 €	1.120 €
178↔182	176,4↔180,4	177↔181		165	83	<b>Y22B177-</b>				924 €	1.017 €	1.120 €	1.120 €
H 140↔220						SPECIAL <b>Y22BSP</b>		+ 38 €	+ 38 €	1.003 €	1.103 €	1.214 €	1.214 €
L 57↔177													
<b>PARETE FISSA</b>													
-	55,4↔57,4	-	57↔59	-	-	<b>Y2F2B57-</b>				375 €	414 €	455 €	455 €
-	57,4↔59,4	-	59↔61	-	-	<b>Y2F2B59-</b>				375 €	414 €	455 €	455 €
-	63,4↔65,4	-	65↔67	-	-	<b>Y2F2B65-</b>				400 €	440 €	484 €	484 €
-	65,4↔67,4	-	67↔69	-	-	<b>Y2F2B67-</b>	●			400 €	440 €	484 €	484 €
-	67,4↔69,4	-	69↔71	-	-	<b>Y2F2B69-</b>				400 €	440 €	484 €	484 €
-	71,4↔73,4	-	73↔75	-	-	<b>Y2F2B73-</b>				425 €	468 €	514 €	514 €
-	73,4↔75,4	-	75↔77	-	-	<b>Y2F2B75-</b>				425 €	468 €	514 €	514 €
-	74,4↔76,4	-	76↔78	-	-	<b>Y2F2B76-</b>				425 €	468 €	514 €	514 €
-	75,4↔77,4	-	77↔79	-	-	<b>Y2F2B77-</b>	●			425 €	468 €	514 €	514 €
-	77,4↔79,4	-	79↔81	-	-	<b>Y2F2B79-</b>				425 €	468 €	514 €	514 €
-	79,4↔81,4	-	81↔83	-	-	<b>Y2F2B81-</b>		+ 38 €	+ 38 €	425 €	468 €	514 €	514 €
-	83,4↔85,4	-	85↔87	-	-	<b>Y2F2B85-</b>				449 €	494 €	544 €	544 €
-	85,4↔87,4	-	87↔89	-	-	<b>Y2F2B87-</b>				449 €	494 €	544 €	544 €
-	87,4↔89,4	-	89↔91	-	-	<b>Y2F2B89-</b>				449 €	494 €	544 €	544 €
-	89,4↔91,4	-	91↔93	-	-	<b>Y2F2B91-</b>				449 €	494 €	544 €	544 €
-	93,4↔95,4	-	95↔97	-	-	<b>Y2F2B95-</b>				449 €	494 €	544 €	544 €
-	95,4↔97,4	-	97↔99	-	-	<b>Y2F2B97-</b>				475 €	523 €	577 €	577 €
-	97,4↔99,4	-	99↔101	-	-	<b>Y2F2B99-</b>				475 €	523 €	577 €	577 €
-	99,4↔101,4	-	101↔103	-	-	<b>Y2F2B101-</b>				475 €	523 €	577 €	577 €
-	115,4↔117,4	-	117↔119	-	-	<b>Y2F2B117-</b>				475 €	523 €	577 €	577 €
-	117,4↔119,4	-	119↔121	-	-	<b>Y2F2B119-</b>				475 €	523 €	577 €	577 €
-			H 140↔220			SPECIAL <b>Y2F2BSP</b>		+ 38 €	+ 38 €	589 €	649 €	714 €	714 €
			L 20↔120										

### BARRA DI SOSTEGNO 150 CM IN DOTAZIONE

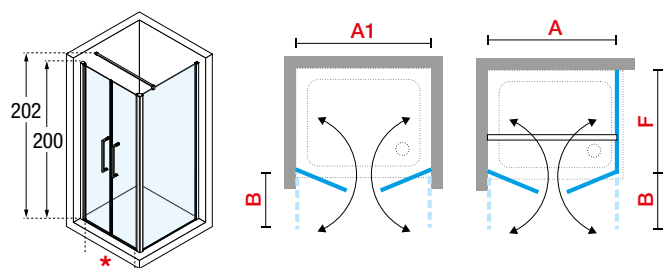

### OPTIONAL

**GUARNIZIONE INFERIORE ORIZZONTALE - L. 100 cm**  
 PER MONTAGGIO SENZA PROFILO INFERIORE DI TENUTA, 100 CM (per box di dimensione superiori a 114 ordinare 2 pezzi)

Codice	Prezzo
<b>R55SPB02A1-TR</b>	25 €

**A** Misura effettiva d'ingombro  
**G** Misura centro lastra

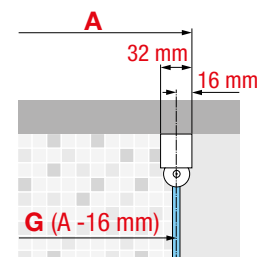



**FINITURE VETRI**



Trasparente  
cod 1



Aqua  
cod 2

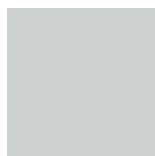

Satin  
cod 4

**FINITURE PROFILI**



Bianco opaco  
cod U

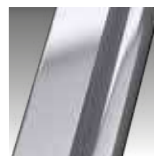

Silver  
cod B



Cromo  
cod K



Nero opaco  
cod H

# YOUNG 2P+F



## PORTA DOCCIA, APERTURA 1 ANTA BATTENTE E 1 FISSA IN LINEA

Installabile in nicchia o abbinabile a parete fissa laterale YOUNG 2.0 F1B

Misure						Codice	Scelta vetro			Scelta profilo			
Misura effettiva d'ingombro con fisso	Misura centro lastra	In nicchia	Fisso in linea	Entrata (cm)	Ingombro anta esterno		1	2	4	U	B	K	H
A	G	A1	F1	*	B		Trasparente	Aqua	Satin	Bianco opaco	Silver	Cromo	Nero opaco
<b>PORTA</b>													
78↔82	76,4↔80,4	77↔81	20↔22	51	51	<b>Y22P77-</b>				628 €	692 €	759 €	759 €
88↔92	86,4↔90,4	87↔91	20↔22	61	61	<b>Y22P87-</b>				655 €	719 €	792 €	792 €
98↔102	96,4↔100,4	97↔101	20↔22	71	71	<b>Y22P97-</b>				680 €	749 €	825 €	825 €
108↔112	106,4↔110,4	107↔111	20↔22	81	81	<b>Y22P107-</b>		+ 38 €	+ 38 €	708 €	779 €	857 €	857 €
118↔122	116,4↔120,4	117↔121	40↔42	71	71	<b>Y22P117-</b>	●			737 €	810 €	892 €	892 €
138↔142	136,4↔140,4	137↔141	40↔42	91	91	<b>Y22P137-</b>				760 €	837 €	922 €	922 €
H 140↔220 L 78↔200						SPECIAL <b>Y22PSP</b>		+ 38 €	+ 38 €	952 €	1.047 €	1.152 €	1.152 €
<b>PARETE FISSA</b>													
	<b>F</b>	<b>G</b>											
57↔59	55,4↔57,4	-	-	-	-	<b>Y2F1B57-</b>				375 €	414 €	455 €	455 €
59↔61	57,4↔59,4	-	-	-	-	<b>Y2F1B59-</b>				375 €	414 €	455 €	455 €
65↔67	63,4↔65,4	-	-	-	-	<b>Y2F1B65-</b>				400 €	440 €	484 €	484 €
67↔69	65,4↔67,4	-	-	-	-	<b>Y2F1B67-</b>	●			400 €	440 €	484 €	484 €
69↔71	67,4↔69,4	-	-	-	-	<b>Y2F1B69-</b>				400 €	440 €	484 €	484 €
73↔75	71,4↔73,4	-	-	-	-	<b>Y2F1B73-</b>				425 €	468 €	514 €	514 €
75↔77	73,4↔75,4	-	-	-	-	<b>Y2F1B75-</b>				425 €	468 €	514 €	514 €
76↔78	74,4↔76,4	-	-	-	-	<b>Y2F1B76-</b>				425 €	468 €	514 €	514 €
77↔79	75,4↔77,4	-	-	-	-	<b>Y2F1B77-</b>	●			425 €	468 €	514 €	514 €
79↔81	77,4↔79,4	-	-	-	-	<b>Y2F1B79-</b>				425 €	468 €	514 €	514 €
81↔83	79,4↔81,4	-	-	-	-	<b>Y2F1B81-</b>		+ 38 €	+ 38 €	425 €	468 €	514 €	514 €
85↔87	83,4↔85,4	-	-	-	-	<b>Y2F1B85-</b>				449 €	494 €	544 €	544 €
87↔89	85,4↔87,4	-	-	-	-	<b>Y2F1B87-</b>	●			449 €	494 €	544 €	544 €
89↔91	87,4↔89,4	-	-	-	-	<b>Y2F1B89-</b>	●			449 €	494 €	544 €	544 €
91↔93	89,4↔91,4	-	-	-	-	<b>Y2F1B91-</b>				449 €	494 €	544 €	544 €
95↔97	93,4↔95,4	-	-	-	-	<b>Y2F1B95-</b>				449 €	494 €	544 €	544 €
97↔99	95,4↔97,4	-	-	-	-	<b>Y2F1B97-</b>	●			475 €	523 €	577 €	577 €
99↔101	97,4↔99,4	-	-	-	-	<b>Y2F1B99-</b>				475 €	523 €	577 €	577 €
101↔103	99,4↔101,4	-	-	-	-	<b>Y2F1B101-</b>				475 €	523 €	577 €	577 €
117↔119	115,4↔117,4	-	-	-	-	<b>Y2F1B117-</b>				475 €	523 €	577 €	577 €
119↔121	117,4↔119,4	-	-	-	-	<b>Y2F1B119-</b>				475 €	523 €	577 €	577 €
H 140↔220 L 20↔120						SPECIAL <b>Y2F1BSP</b>		+ 38 €	+ 38 €	589 €	649 €	714 €	714 €

PER INSTALLAZIONE CON PANNELLO FISSO LATERALE ORDINARE BARRA DI SOSTEGNO R80LOU450 (VEDI PAG. 070)

### OPTIONAL

**BARRA A "T" IN ABBINAMENTO COL FISSO**

Finitura	Codice	Prezzo
Bianco	<b>R80Y22P15T-U</b>	67 €
Silver	<b>R80Y22P15T-B</b>	72 €
Cromo	<b>R80Y22P15T-K</b>	78 €
Nero opaco	<b>R80Y22P15T-H</b>	78 €

**GUARNIZIONE INFERIORE ORIZZONTALE**  
PER MONTAGGIO SENZA PROFILO INFERIORE DI TENUTA, 100 CM

Codice	Prezzo
<b>R55SPBOM01-TR</b>	43 €

**A** Misura effettiva d'ingombro  
**G** Misura centro lastra

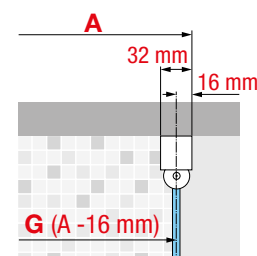
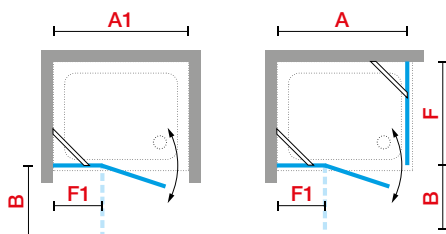
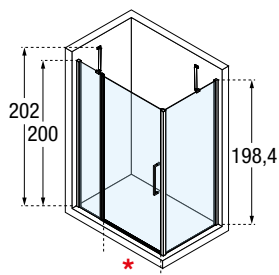



**FINITURE VETRI**



Trasparente  
cod 1



Aqua  
cod 2



Satin  
cod 4

**FINITURE PROFILI**



Bianco opaco  
cod U

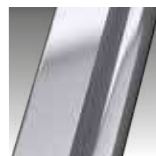

Silver  
cod B



Cromo  
cod K



Nero opaco  
cod H

# YOUNG 2P+FL



## PORTA DOCCIA APERTURA 1 ANTA BATTENTE E 2 FISSI IN LINEA

Installabile in nicchia o abbinabile a parete fissa laterale YOUNG 2.0 F1B

Misure							Codice	Scelta vetro			Scelta profilo			
Misura effettiva d'ingombro		Misura centro lastra	Fisso in linea	Entrata (cm)		Ingombro anta esterno		1	2	4	U	B	K	H
con fisso	In nicchia													
A	A1	G	F1	F2	*	B		Traspa- rente	Aqua	Satinato	Bianco opaco	Silver	Cromo	Nero opaco
<b>PORTA</b>														
138↔142	137↔141	136,4↔140,4	20↔22	54	60	61	<b>Y22PFL137-</b>				1.003 €	1.104 €	1.214 €	1.214 €
148↔152	147↔151	156,4↔150,4	20↔22	54	70	71	<b>Y22PFL147-</b>				1.029 €	1.133 €	1.247 €	1.247 €
158↔162	157↔161	156,4↔160,4	20↔22	64	70	71	<b>Y22PFL157-</b>				1.054 €	1.158 €	1.274 €	1.274 €
168↔172	167↔171	166,4↔170,4	20↔22	74	70	71	<b>Y22PFL167-</b>		+76 €	+76 €	1.080 €	1.187 €	1.305 €	1.305 €
178↔182	177↔181	176,4↔180,4	20↔22	84	70	71	<b>Y22PFL177-</b>				1.103 €	1.213 €	1.335 €	1.335 €
188↔192	187↔191	186,4↔190,4	40↔42	64	80	81	<b>Y22PFL187-</b>				1.135 €	1.250 €	1.375 €	1.375 €
198↔202	197↔201	196,4↔200,4	40↔42	74	80	81	<b>Y22PFL197-</b>				1.162 €	1.278 €	1.405 €	1.405 €
<b>PARETE FISSA</b>														
<b>F</b>														
57↔59	-	55,4↔57,4	-	-	-	-	<b>Y2F1B57-</b>				375 €	414 €	455 €	455 €
59↔61	-	57,4↔59,4	-	-	-	-	<b>Y2F1B59-</b>				375 €	414 €	455 €	455 €
65↔67	-	63,4↔65,4	-	-	-	-	<b>Y2F1B65-</b>				400 €	440 €	484 €	484 €
67↔69	-	65,4↔67,4	-	-	-	-	<b>Y2F1B67-</b>	●			400 €	440 €	484 €	484 €
69↔71	-	67,4↔69,4	-	-	-	-	<b>Y2F1B69-</b>				400 €	440 €	484 €	484 €
73↔75	-	71,4↔73,4	-	-	-	-	<b>Y2F1B73-</b>				425 €	468 €	514 €	514 €
75↔77	-	73,4↔75,4	-	-	-	-	<b>Y2F1B75-</b>				425 €	468 €	514 €	514 €
76↔78	-	74,4↔76,4	-	-	-	-	<b>Y2F1B76-</b>				425 €	468 €	514 €	514 €
77↔79	-	75,4↔77,4	-	-	-	-	<b>Y2F1B77-</b>	●			425 €	468 €	514 €	514 €
79↔81	-	77,4↔79,4	-	-	-	-	<b>Y2F1B79-</b>				425 €	468 €	514 €	514 €
81↔83	-	79,4↔81,4	-	-	-	-	<b>Y2F1B81-</b>		+38 €	+38 €	425 €	468 €	514 €	514 €
85↔87	-	83,4↔85,4	-	-	-	-	<b>Y2F1B85-</b>				449 €	494 €	544 €	544 €
87↔89	-	85,4↔87,4	-	-	-	-	<b>Y2F1B87-</b>	●			449 €	494 €	544 €	544 €
89↔91	-	87,4↔89,4	-	-	-	-	<b>Y2F1B89-</b>	●			449 €	494 €	544 €	544 €
91↔93	-	89,4↔91,4	-	-	-	-	<b>Y2F1B91-</b>	●			449 €	494 €	544 €	544 €
95↔97	-	93,4↔95,4	-	-	-	-	<b>Y2F1B95-</b>				449 €	494 €	544 €	544 €
97↔99	-	95,4↔97,4	-	-	-	-	<b>Y2F1B97-</b>	●			475 €	523 €	577 €	577 €
99↔101	-	97,4↔99,4	-	-	-	-	<b>Y2F1B99-</b>				475 €	523 €	577 €	577 €
101↔103	-	99,4↔101,4	-	-	-	-	<b>Y2F1B101-</b>				475 €	523 €	577 €	577 €
117↔119	-	115,4↔117,4	-	-	-	-	<b>Y2F1B117-</b>				475 €	523 €	577 €	577 €
119↔121	-	117,4↔119,4	-	-	-	-	<b>Y2F1B119-</b>				475 €	523 €	577 €	577 €
H 140↔120	-	-	-	-	-	SPECIAL	<b>Y2F1BSP</b>		+38 €	+38 €	589 €	649 €	714 €	714 €

**GUARNIZIONE INFERIORE ORIZZONTALE**  
PER MONTAGGIO SENZA PROFILO INFERIORE DI TENUTA, 100 CM

Codice **R55SPBOM01-TR** Prezzo 43 €

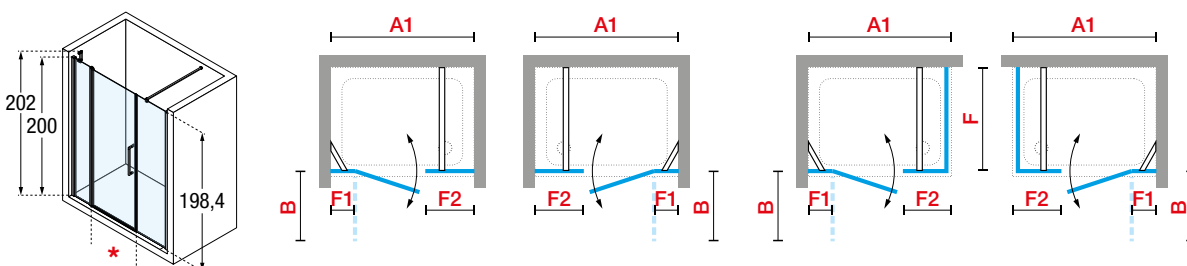



**FINITURE VETRI**



Trasparente  
cod 1



Aqua  
cod 2

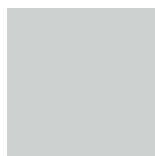

Satin  
cod 4

**FINITURE PROFILI**



Bianco opaco  
cod U

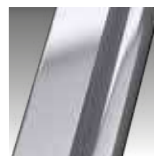

Silver  
cod B



Cromo  
cod K



Nero opaco  
cod H

## BOX DOCCIA AD ANGOLO APERTURA 1 ANTA BATTENTE CON 1 PARETE FISSA LATERALE

Misure					Codice	Scelta vetro			Scelta profilo			
Misura effettiva d'ingombro	Misura centro lastra	Fisso laterale	Entrata (cm)	Ingombro anta esterno		1	2	4	U	B	K	H
A	G	F	*	B		Trasparente	Aqua	Satin	Bianco opaco	Silver	Cromo	Nero opaco
<b>PORTA</b>												
57↔59	55,4↔57,4		48	49	<b>Y2G57-</b>				423 €	465 €	512 €	512 €
59↔61	57,4↔59,4		50	51	<b>Y2G59-</b>				423 €	465 €	512 €	512 €
61↔63	59,4↔61,4		52	53	<b>Y2G61-</b>				423 €	465 €	512 €	512 €
65↔67	63,4↔65,4		56	57	<b>Y2G65-</b>				423 €	465 €	512 €	512 €
67↔69	65,4↔67,4		58	59	<b>Y2G67-</b>				444 €	489 €	539 €	539 €
69↔71	67,4↔69,4		60	61	<b>Y2G69-</b>				444 €	489 €	539 €	539 €
72↔74	70,4↔72,4		63	64	<b>Y2G72-</b>				444 €	489 €	539 €	539 €
74↔76	72,4↔74,4		65	66	<b>Y2G74-</b>				444 €	489 €	539 €	539 €
76↔78	74,4↔76,4		67	68	<b>Y2G76-</b>				444 €	489 €	539 €	539 €
77↔79	75,4↔77,4		68	69	<b>Y2G77-</b>	●			467 €	513 €	565 €	565 €
79↔81	77,4↔79,4		70	71	<b>Y2G79-</b>		+ 38 €	+ 38 €	467 €	513 €	565 €	565 €
81↔83	79,4↔81,4		72	73	<b>Y2G81-</b>				467 €	513 €	565 €	565 €
85↔87	83,4↔85,4		76	77	<b>Y2G85-</b>				467 €	513 €	565 €	565 €
87↔89	85,4↔87,4		78	79	<b>Y2G87-</b>	●			488 €	538 €	592 €	592 €
89↔91	87,4↔89,4		80	81	<b>Y2G89-</b>				488 €	538 €	592 €	592 €
91↔93	89,4↔91,4		82	83	<b>Y2G91-</b>				488 €	538 €	592 €	592 €
93↔95	91,4↔93,4		84	85	<b>Y2G93-</b>				488 €	538 €	592 €	592 €
95↔97	93,4↔95,4		86	87	<b>Y2G95-</b>				488 €	538 €	592 €	592 €
97↔99	95,4↔97,4		88	89	<b>Y2G97-</b>	●			510 €	563 €	620 €	620 €
99↔101	97,4↔99,4		90	91	<b>Y2G99-</b>				510 €	563 €	620 €	620 €
101↔103	99,4↔101,4		92	93	<b>Y2G101-</b>				510 €	563 €	620 €	620 €
H 140↔220 L 50↔120				SPECIAL	<b>Y2GSP</b>		+ 38 €	+ 38 €	637 €	702 €	772 €	772 €
<b>PARETE FISSA</b>												
	55,4↔57,4	57↔59	-	-	<b>Y2FG57-</b>				375 €	414 €	455 €	455 €
	57,4↔59,4	59↔61	-	-	<b>Y2FG59-</b>				375 €	414 €	455 €	455 €
	59,4↔61,4	61↔63	-	-	<b>Y2FG61-</b>				375 €	414 €	455 €	455 €
	63,4↔65,4	65↔67	-	-	<b>Y2FG65-</b>				400 €	440 €	484 €	484 €
	65,4↔67,4	67↔69	-	-	<b>Y2FG67-</b>	●			400 €	440 €	484 €	484 €
	67,4↔69,4	69↔71	-	-	<b>Y2FG69-</b>				400 €	440 €	484 €	484 €
	71,4↔73,4	73↔75	-	-	<b>Y2FG73-</b>				425 €	468 €	514 €	514 €
	73,4↔75,4	75↔77	-	-	<b>Y2FG75-</b>				425 €	468 €	514 €	514 €
	74,4↔76,4	76↔78	-	-	<b>Y2FG76-</b>				425 €	468 €	514 €	514 €
	75,4↔77,4	77↔79	-	-	<b>Y2FG77-</b>	●			425 €	468 €	514 €	514 €
	77,4↔79,4	79↔81	-	-	<b>Y2FG79-</b>				425 €	468 €	514 €	514 €
	79,4↔81,4	81↔83	-	-	<b>Y2FG81-</b>		+ 38 €	+ 38 €	425 €	468 €	514 €	514 €
	83,4↔85,4	85↔87	-	-	<b>Y2FG85-</b>				449 €	494 €	544 €	544 €
	85,4↔87,4	87↔89	-	-	<b>Y2FG87-</b>	●			449 €	494 €	544 €	544 €
	87,4↔89,4	89↔91	-	-	<b>Y2FG89-</b>				449 €	494 €	544 €	544 €
	89,4↔91,4	91↔93	-	-	<b>Y2FG91-</b>				449 €	494 €	544 €	544 €
	91,4↔93,4	93↔95	-	-	<b>Y2FG93-</b>				449 €	494 €	544 €	544 €
	93,4↔95,4	95↔97	-	-	<b>Y2FG95-</b>				449 €	494 €	544 €	544 €
	95,4↔97,4	97↔99	-	-	<b>Y2FG97-</b>				475 €	523 €	577 €	577 €
	97,4↔99,4	99↔101	-	-	<b>Y2FG99-</b>				475 €	523 €	577 €	577 €
	99,4↔101,4	101↔103	-	-	<b>Y2FG101-</b>				475 €	523 €	577 €	577 €
	115,4↔117,4	117↔119	-	-	<b>Y2FG117-</b>				475 €	523 €	577 €	577 €
	117,4↔119,4	119↔121	-	-	<b>Y2FG119-</b>				475 €	523 €	577 €	577 €
	H 100↔220 L 20↔140			SPECIAL	<b>Y2FGSP</b>		+ 38 €	+ 38 €	589 €	649 €	714 €	714 €

**IL FISSO SPECIALE DEVE ESSERE ORDINATO DELLA STESSA ALTEZZA TOTALE DELLA PORTA. BARRA DI SOSTEGNO 150 CM IN DOTAZIONE.**

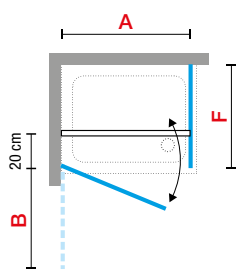
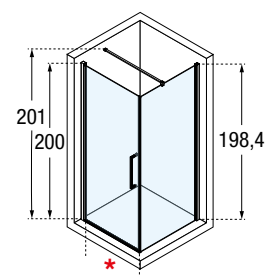

### OPTIONAL

**GUARNIZIONE INFERIORE ORIZZONTALE**  
PER MONTAGGIO SENZA PROFILO INFERIORE DI TENUTA, 100 CM

Codice	Prezzo
<b>R55SPBOM01-TR</b>	43 €

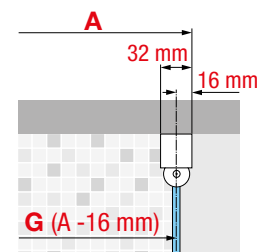





APERTURA INTERNA / ESTERNA

**FINITURE VETRI**



Trasparente  
cod 1



Aqua  
cod 2



Satin  
cod 4

**FINITURE PROFILI**



Bianco opaco  
cod U

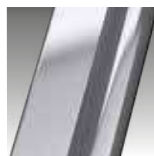

Silver  
cod B



Cromo  
cod K



Nero opaco  
cod H

## BOX DOCCIA AD ANGOLO APERTURA 2 ANTE BATTENTI

Misure				Codice	Scelta vetro			Scelta profilo			
Misura effettiva d'ingombro	Misura centro lastra	Entrata (cm)	Ingombro anta esterno		1	2	4	U	B	K	H
<b>A</b>	<b>G</b>	*	<b>B</b>		Trasparente	Aqua	Satin	Bianco opaco	Silver	Cromo	Nero opaco
57↔59	55,4↔57,4	69	49	<b>Y22G57L-</b>				423 €	465 €	512 €	512 €
59↔61	57,4↔59,4	72	51	<b>Y22G59L-</b>				423 €	465 €	512 €	512 €
61↔63	59,4↔61,4	75	53	<b>Y22G61L-</b>				423 €	465 €	512 €	512 €
65↔67	63,4↔65,4	81	57	<b>Y22G65L-</b>				423 €	465 €	512 €	512 €
67↔69	65,4↔67,4	84	59	<b>Y22G67L-</b>				444 €	489 €	539 €	539 €
69↔71	67,4↔69,4	87	61	<b>Y22G69L-</b>				444 €	489 €	539 €	539 €
72↔74	70,4↔72,4	91	64	<b>Y22G72L-</b>				444 €	489 €	539 €	539 €
74↔76	72,4↔74,4	94	66	<b>Y22G74L-</b>				444 €	489 €	539 €	539 €
76↔78	74,4↔76,4	96	68	<b>Y22G76L-</b>				444 €	489 €	539 €	539 €
77↔79	75,4↔77,4	98	69	<b>Y22G77L-</b>				467 €	513 €	565 €	565 €
79↔81	77,4↔79,4	101	71	<b>Y22G79L-</b>				467 €	513 €	565 €	565 €
81↔83	79,4↔81,4	103	73	<b>Y22G81L-</b>				467 €	513 €	565 €	565 €
85↔87	83,4↔85,4	109	77	<b>Y22G85L-</b>				467 €	513 €	565 €	565 €
87↔89	85,4↔87,4	112	79	<b>Y22G87L-</b>				488 €	538 €	592 €	592 €
89↔91	87,4↔89,4	115	81	<b>Y22G89L-</b>				488 €	538 €	592 €	592 €
91↔93	89,4↔91,4	117	83	<b>Y22G91L-</b>				488 €	538 €	592 €	592 €
95↔97	93,4↔95,4	124	87	<b>Y22G95L-</b>				488 €	538 €	592 €	592 €
97↔99	95,4↔97,4	127	89	<b>Y22G97L-</b>				510 €	563 €	620 €	620 €
99↔101	97,4↔99,4	130	91	<b>Y22G99L-</b>				510 €	563 €	620 €	620 €
101↔103	99,4↔101,4	133	93	<b>Y22G101L-</b>				510 €	563 €	620 €	620 €
H 140↔220 L 30↔108			SPECIAL	<b>Y22GLSP</b>				637 €	702 €	772 €	772 €

### PER COMPORRE UN ANGOLO ORDINARE 2 LATI

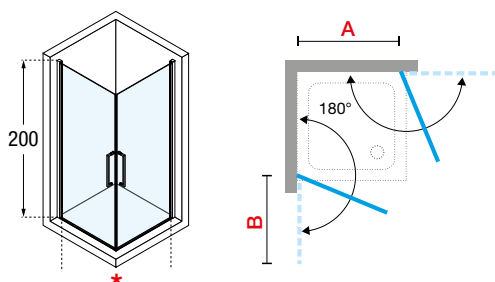

### OPTIONAL

**GUARNIZIONE INFERIORE ORIZZONTALE**  
PER MONTAGGIO SENZA PROFILO INFERIORE DI TENUTA, 100 CM

Codice	Prezzo
<b>R55SPBOA01-TR</b>	43 €

**A** Misura effettiva d'ingombro  
**G** Misura centro lastra

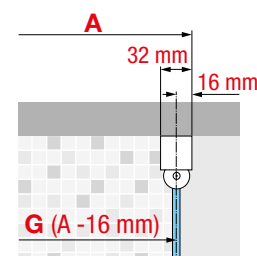



**FINITURE VETRI**



Trasparente  
cod 1



Aqua  
cod 2

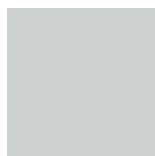

Satin  
cod 4

**FINITURE PROFILI**



Bianco opaco  
cod U

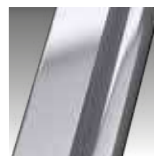

Silver  
cod B



Cromo  
cod K



Nero opaco  
cod H

# YOUNG 1BS



## PORTA DOCCIA, APERTURA 1 ANTA BATTENTE E RIPIEGABILE A SOFFIETTO

Installabile in nicchia o abbinabile a parete fissa laterale YOUNG 2.0 F1B

Misure					Codice	Destra	Sinistra	Scelta vetro			Scelta profilo			
Misura effettiva d'ingombro con fisso	Misura centro lastra	Misura effettiva d'ingombro	Entrata (cm)	Ingombro anta		D-	S-	1	2	4	U	B	K	H
A	G	A1	*	B B1				Trasparente	Aqua	Satin	Bianco opaco	Silver	Cromo	Nero opaco
<b>PORTA</b>														
58↔62	56,4↔60,4	57↔61	41	47 27	<b>Y21BS57</b>	D-	S-				688 €	757 €	833 €	833 €
68↔72	66,4↔70,4	67↔71	51	57 32	<b>Y21BS67</b>	D-	S-				715 €	787 €	865 €	865 €
73↔77	71,4↔75,4	72↔76	56	62 35	<b>Y21BS72</b>	D-	S-				715 €	787 €	865 €	865 €
78↔82	76,4↔80,4	77↔81	61	67 37	<b>Y21BS77</b>	D-	S-	●			742 €	817 €	899 €	899 €
83↔87	81,4↔85,4	82↔86	66	72 40	<b>Y21BS82</b>	D-	S-				742 €	817 €	899 €	899 €
88↔92	86,4↔90,4	87↔91	71	77 42	<b>Y21BS87</b>	D-	S-	●	+ 38 €	+ 38 €	769 €	847 €	932 €	932 €
95↔99	93,4↔97,4	94↔98	78	84 46	<b>Y21BS94</b>	D-	S-				769 €	847 €	932 €	932 €
98↔102	96,4↔100,4	97↔101	81	87 47	<b>Y21BS97</b>	D-	S-	●			795 €	875 €	963 €	963 €
108↔112	106,4↔110,4	107↔111	91	97 52	<b>Y21BS107</b>	D-	S-				795 €	875 €	963 €	963 €
116↔120	114,4↔118,4	115↔119	99	105 55	<b>Y21BS115</b>	D-	S-				823 €	905 €	997 €	997 €
118↔122	116,4↔120,4	117↔121	101	107 57	<b>Y21BS117</b>	D-	S-				823 €	905 €	997 €	997 €
<b>PARETE FISSA</b>														
57↔59	55,4↔57,4	-	-	-	<b>Y2F1B57-</b>						375 €	414 €	455 €	455 €
59↔61	57,4↔59,4	-	-	-	<b>Y2F1B59-</b>						375 €	414 €	455 €	455 €
65↔67	63,4↔65,4	-	-	-	<b>Y2F1B65-</b>						400 €	440 €	484 €	484 €
67↔69	65,4↔67,4	-	-	-	<b>Y2F1B67-</b>			●			400 €	440 €	484 €	484 €
69↔71	67,4↔69,4	-	-	-	<b>Y2F1B69-</b>						400 €	440 €	484 €	484 €
73↔75	71,4↔73,4	-	-	-	<b>Y2F1B73-</b>						425 €	468 €	514 €	514 €
75↔77	73,4↔75,4	-	-	-	<b>Y2F1B75-</b>						425 €	468 €	514 €	514 €
76↔78	74,4↔76,4	-	-	-	<b>Y2F1B76-</b>						425 €	468 €	514 €	514 €
77↔79	75,4↔77,4	-	-	-	<b>Y2F1B77-</b>			●			425 €	468 €	514 €	514 €
79↔81	77,4↔79,4	-	-	-	<b>Y2F1B79-</b>						425 €	468 €	514 €	514 €
81↔83	79,4↔81,4	-	-	-	<b>Y2F1B81-</b>	-	-		+ 38 €	+ 38 €	425 €	468 €	514 €	514 €
85↔87	83,4↔85,4	-	-	-	<b>Y2F1B85-</b>						449 €	494 €	544 €	544 €
87↔89	85,4↔87,4	-	-	-	<b>Y2F1B87-</b>			●			449 €	494 €	544 €	544 €
89↔91	87,4↔89,4	-	-	-	<b>Y2F1B89-</b>			●			449 €	494 €	544 €	544 €
91↔93	89,4↔91,4	-	-	-	<b>Y2F1B91-</b>						449 €	494 €	544 €	544 €
95↔97	93,4↔95,4	-	-	-	<b>Y2F1B95-</b>						449 €	494 €	544 €	544 €
97↔99	95,4↔97,4	-	-	-	<b>Y2F1B97-</b>			●			475 €	523 €	577 €	577 €
99↔101	97,4↔99,4	-	-	-	<b>Y2F1B99-</b>						475 €	523 €	577 €	577 €
101↔103	99,4↔101,4	-	-	-	<b>Y2F1B101-</b>						475 €	523 €	577 €	577 €
117↔119	115,4↔117,4	-	-	-	<b>Y2F1B117-</b>						475 €	523 €	577 €	577 €
119↔121	117,4↔119,4	-	-	-	<b>Y2F1B119-</b>						475 €	523 €	577 €	577 €
H 140↔220 L 20↔120					SPECIAL <b>Y2F1BSP</b>	-	-		+ 38 €	+ 38 €	589 €	649 €	714 €	714 €

**IL FISSO SPECIALE DEVE ESSERE ORDINATO DELLA STESSA ALTEZZA TOTALE DELLA PORTA  
BARRA DI SOSTEGNO 150 CM IN DOTAZIONE**

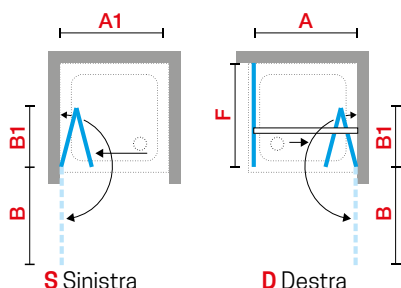
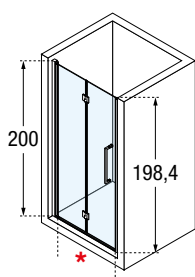

### OPTIONAL

**GUARNIZIONE INFERIORE ORIZZONTALE**  
PER MONTAGGIO SENZA PROFILO INFERIORE DI TENUTA, 100 CM

Codice	Prezzo
<b>R55SPBOM01-TR</b>	43 €

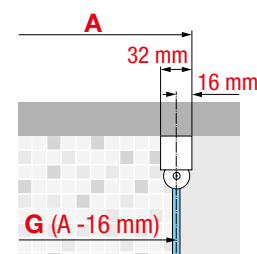

050



Costruzione del codice

**Codice** + **Sinistra/Destra** + **Vetro** + **Profilo** = Codice prodotto finale





GUARNIZIONE VERTICALE PORTA

FINITURE VETRI



Trasparente  
cod 1



Aqua  
cod 2



Satin  
cod 4

FINITURE PROFILI



Bianco opaco  
cod U

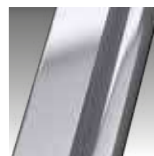

Silver  
cod B



Cromo  
cod K



Nero opaco  
cod H

# YOUNG 2GS



## BOX DOCCIA AD ANGOLO APERTURA 2 ANTE RIPIEGABILI A SOFFIETTO

Misure					Codice	Destra	Sinistra	Scelta vetro			Scelta profilo			
Misura effettiva d'ingombro	Misura centro lastra	Entrata (cm)	Ingombro anta			D-	S-	1	2	4	U	B	K	H
<b>A</b>	<b>G</b>	<b>*</b>	<b>B</b>	<b>B1</b>				Trasparente	Aqua	Satin	Bianco opaco	Silver	Cromo	Nero opaco
57↔59	55,4↔57,4	69	49	26	<b>Y22GS57L</b>	D-	S-				538 €	592 €	650 €	650 €
59↔61	57,4↔59,4	72	51	27	<b>Y22GS59L</b>	D-	S-				538 €	592 €	650 €	650 €
65↔67	63,4↔65,4	81	57	30	<b>Y22GS65L</b>	D-	S-				538 €	592 €	650 €	650 €
67↔69	65,4↔67,4	83	59	31	<b>Y22GS67L</b>	D-	S-				538 €	592 €	650 €	650 €
69↔71	67,4↔69,4	86	61	32	<b>Y22GS69L</b>	D-	S-				563 €	619 €	680 €	680 €
73↔75	71,4↔73,4	92	65	34	<b>Y22GS73L</b>	D-	S-				563 €	619 €	680 €	680 €
75↔77	73,4↔75,4	95	67	35	<b>Y22GS75L</b>	D-	S-				563 €	619 €	680 €	680 €
76↔78	74,4↔76,4	96	68	36	<b>Y22GS76L</b>	D-	S-				563 €	619 €	680 €	680 €
77↔79	75,4↔77,4	98	69	36	<b>Y22GS77L</b>	D-	S-				563 €	619 €	680 €	680 €
79↔81	77,4↔79,4	100	71	37	<b>Y22GS79L</b>	D-	S-				589 €	648 €	713 €	713 €
81↔83	79,4↔81,4	103	73	38	<b>Y22GS81L</b>	D-	S-				589 €	648 €	713 €	713 €
85↔87	83,4↔85,4	109	77	40	<b>Y22GS85L</b>	D-	S-	+ 38 €	+ 38 €		589 €	648 €	713 €	713 €
87↔89	85,4↔87,4	112	79	41	<b>Y22GS87L</b>	D-	S-				589 €	648 €	713 €	713 €
89↔91	87,4↔89,4	115	81	42	<b>Y22GS89L</b>	D-	S-				589 €	648 €	713 €	713 €
91↔93	89,4↔91,4	117	83	43	<b>Y22GS91L</b>	D-	S-				589 €	648 €	713 €	713 €
95↔97	93,4↔95,4	123	87	45	<b>Y22GS95L</b>	D-	S-				614 €	675 €	743 €	743 €
97↔99	95,4↔97,4	126	89	46	<b>Y22GS97L</b>	D-	S-				614 €	675 €	743 €	743 €
99↔101	97,4↔99,4	129	91	47	<b>Y22GS99L</b>	D-	S-				614 €	675 €	743 €	743 €
101↔103	99,4↔101,4	132	93	48	<b>Y22GS101L</b>	D-	S-				614 €	675 €	743 €	743 €
105↔107	103,4↔105,4	141	97	50	<b>Y22GS105L</b>	D-	S-				614 €	675 €	743 €	743 €
115↔117	113,4↔115,4	151	107	55	<b>Y22GS115L</b>	D-	S-				614 €	675 €	743 €	743 €
117↔119	115,4↔117,4	154	109	56	<b>Y22GS117L</b>	D-	S-				640 €	704 €	775 €	775 €
119↔121	117,4↔119,4	157	111	57	<b>Y22GS119L</b>	D-	S-				640 €	704 €	775 €	775 €

### PER COMPORRE UN ANGOLO ORDINARE 2 LATI (1 LATO DESTRO + 1 LATO SINISTRO)

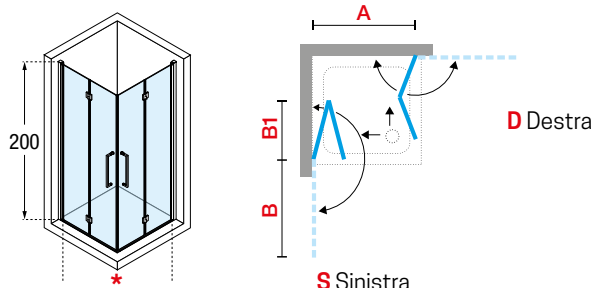

#### OPTIONAL

**GUARNIZIONE INFERIORE ORIZZONTALE**  
PER MONTAGGIO SENZA PROFILO INFERIORE DI TENUTA, 100 CM

Codice	Prezzo
<b>R55SPBOA01-TR</b>	43 €

**A** Misura effettiva d'ingombro  
**G** Misura centro lastra

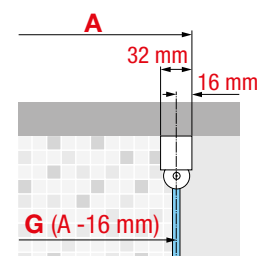



**GUARNIZIONE VERTICALE PORTA**

**FINITURE VETRI**



Trasparente  
cod 1



Aqua  
cod 2



Satin  
cod 4

**FINITURE PROFILI**



Bianco opaco  
cod U

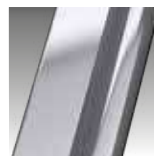

Silver  
cod B



Cromo  
cod K



Nero opaco  
cod H

# YOUNG 2GS+F



## BOX DOCCIA AD ANGOLO APERTURA 1 ANTA BATTENTE E RIPIEGABILE A SOFFIETTO CON 1 PARETE FISSA LATERALE

Misure					Codice	Destra	Sinistra	Scelta vetro			Scelta profilo				
Misura effettiva d'ingombro	Misura centro lastra	Fisso laterale	Entrata (cm)	Ingombro anta		D-	S-	1	2	4	U	B	K	H	
A	G	F	*	B B1				Traspa- rente	Aqua	Satin	Bianco opaco	Silver	Cromo	Nero opaco	
<b>PORTA</b>															
58↔60	56,4↔58,4		49	49 26	<b>Y22GS57L</b>	D-	S-					538 €	592 €	650 €	650 €
60↔62	58,4↔60,4		51	51 27	<b>Y22GS59L</b>	D-	S-					538 €	592 €	650 €	650 €
66↔68	64,4↔66,4		57	57 30	<b>Y22GS65L</b>	D-	S-					538 €	592 €	650 €	650 €
68↔70	66,4↔68,4		59	59 31	<b>Y22GS67L</b>	D-	S-					538 €	592 €	650 €	650 €
70↔72	68,4↔70,4		61	61 32	<b>Y22GS69L</b>	D-	S-					563 €	619 €	680 €	680 €
74↔76	72,4↔74,4		65	65 34	<b>Y22GS73L</b>	D-	S-					563 €	619 €	680 €	680 €
76↔78	74,4↔76,4		67	67 35	<b>Y22GS75L</b>	D-	S-					563 €	619 €	680 €	680 €
77↔79	75,4↔77,4		68	68 36	<b>Y22GS76L</b>	D-	S-					563 €	619 €	680 €	680 €
78↔80	76,4↔78,4		69	69 36	<b>Y22GS77L</b>	D-	S-					563 €	619 €	680 €	680 €
80↔82	78,4↔80,4		71	71 37	<b>Y22GS79L</b>	D-	S-					589 €	648 €	713 €	713 €
82↔84	80,4↔82,4		73	73 38	<b>Y22GS81L</b>	D-	S-					589 €	648 €	713 €	713 €
86↔88	84,4↔86,4		77	77 40	<b>Y22GS85L</b>	D-	S-		+ 38 €	+ 38 €		589 €	648 €	713 €	713 €
88↔90	86,4↔88,4		79	79 41	<b>Y22GS87L</b>	D-	S-					589 €	648 €	713 €	713 €
90↔92	88,4↔90,4		81	81 42	<b>Y22GS89L</b>	D-	S-					589 €	648 €	713 €	713 €
92↔94	90,4↔92,4		83	83 43	<b>Y22GS91L</b>	D-	S-					589 €	648 €	713 €	713 €
96↔98	94,4↔96,4		87	87 45	<b>Y22GS95L</b>	D-	S-					614 €	675 €	743 €	743 €
98↔100	96,4↔98,4		89	89 46	<b>Y22GS97L</b>	D-	S-					614 €	675 €	743 €	743 €
100↔102	98,4↔100,4		91	91 47	<b>Y22GS99L</b>	D-	S-					614 €	675 €	743 €	743 €
102↔104	100,4↔102,4		93	93 48	<b>Y22GS101L</b>	D-	S-					614 €	675 €	743 €	743 €
106↔108	104,4↔106,4		97	97 50	<b>Y22GS105L</b>	D-	S-					614 €	675 €	743 €	743 €
116↔118	114,4↔116,4		107	107 55	<b>Y22GS115L</b>	D-	S-					614 €	675 €	743 €	743 €
118↔120	116,4↔118,4		109	109 56	<b>Y22GS117L</b>	D-	S-					640 €	704 €	775 €	775 €
120↔122	118,4↔120,4		111	111 57	<b>Y22GS119L</b>	D-	S-					640 €	704 €	775 €	775 €
<b>PARETE FISSA</b>															
-	55,4↔57,4	57↔59	-	-	<b>Y2FG57-</b>							375 €	414 €	455 €	455 €
-	57,4↔59,4	59↔61	-	-	<b>Y2FG59-</b>							375 €	414 €	455 €	455 €
-	59,4↔61,4	61↔63	-	-	<b>Y2FG61-</b>							375 €	414 €	455 €	455 €
-	63,4↔65,4	65↔67	-	-	<b>Y2FG65-</b>							400 €	440 €	484 €	484 €
-	65,4↔67,4	67↔69	-	-	<b>Y2FG67-</b>							400 €	440 €	484 €	484 €
-	67,4↔69,4	69↔71	-	-	<b>Y2FG69-</b>							400 €	440 €	484 €	484 €
-	71,4↔73,4	73↔75	-	-	<b>Y2FG73-</b>							425 €	468 €	514 €	514 €
-	73,4↔75,4	75↔77	-	-	<b>Y2FG75-</b>							425 €	468 €	514 €	514 €
-	74,4↔76,4	76↔78	-	-	<b>Y2FG76-</b>							425 €	468 €	514 €	514 €
-	75,4↔77,4	77↔79	-	-	<b>Y2FG77-</b>							425 €	468 €	514 €	514 €
-	77,4↔79,4	79↔81	-	-	<b>Y2FG79-</b>							425 €	468 €	514 €	514 €
-	79,4↔81,4	81↔83	-	-	<b>Y2FG81-</b>	-	-		+ 38 €	+ 38 €		425 €	468 €	514 €	514 €
-	83,4↔85,4	85↔87	-	-	<b>Y2FG85-</b>							449 €	494 €	544 €	544 €
-	85,4↔87,4	87↔89	-	-	<b>Y2FG87-</b>							449 €	494 €	544 €	544 €
-	87,4↔89,4	89↔91	-	-	<b>Y2FG89-</b>							449 €	494 €	544 €	544 €
-	89,4↔91,4	91↔93	-	-	<b>Y2FG91-</b>							449 €	494 €	544 €	544 €
-	91,4↔93,4	93↔95	-	-	<b>Y2FG93-</b>							449 €	494 €	544 €	544 €
-	93,4↔95,4	95↔97	-	-	<b>Y2FG95-</b>							449 €	494 €	544 €	544 €
-	95,4↔97,4	97↔99	-	-	<b>Y2FG97-</b>							475 €	523 €	577 €	577 €
-	97,4↔99,4	99↔101	-	-	<b>Y2FG99-</b>							475 €	523 €	577 €	577 €
-	99,4↔101,4	101↔103	-	-	<b>Y2FG101-</b>							475 €	523 €	577 €	577 €
-	115,4↔117,4	117↔119	-	-	<b>Y2FG117-</b>							475 €	523 €	577 €	577 €
-	117,4↔119,4	119↔121	-	-	<b>Y2FG119-</b>							475 €	523 €	577 €	577 €
	H 100↔220			SPECIAL	<b>Y2FGSP</b>	-	-		+ 38 €	+ 38 €		589 €	649 €	714 €	714 €

### BARRA DI SOSTEGNO 150 CM IN DOTAZIONE

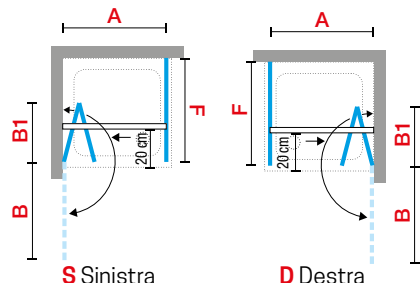
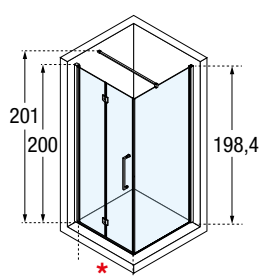

### OPTIONAL

**GUARNIZIONE INFERIORE ORIZZONTALE**  
PER MONTAGGIO SENZA PROFILO INFERIORE DI TENUTA, 100 CM

Codice	Prezzo
<b>R55SPBOA01-TR</b>	43 €

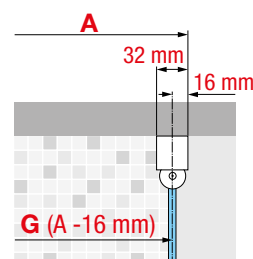





GUARNIZIONE VERTICALE PORTA

**FINITURE VETRI**



Trasparente  
cod 1



Aqua  
cod 2

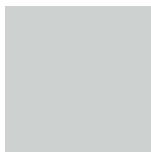

Satin  
cod 4

**FINITURE PROFILI**



Bianco opaco  
cod U



Silver  
cod B



Cromo  
cod K



Nero opaco  
cod H

## BOX DOCCIA AD ANGOLO APERTURA 2 ANTE RIPIEGABILI A SOFFIETTO

Misure							Codice	Destra	Sinistra	Scelta vetro		Scelta profilo			
Misura effettiva d'ingombro	Misura centro lastra	Ante		Entrata	Ingombro ante esterno	Ingombro ante interno		D-	S-	1	2	U	B	K	H
A	G	A1	A2	*	B	B1				Trasparente	Aqua	Bianco opaco	Silver	Cromo	Nero opaco
57↔59	55,4↔57,4	32	24	69	52	32	<b>Y22AS57L</b>	D-	S-			677 €	743 €	814 €	814 €
59↔61	57,4↔59,4	33	25	72	54	33	<b>Y22AS59L</b>	D-	S-			677 €	743 €	814 €	814 €
65↔67	63,4↔65,4	36	28	81	60	36	<b>Y22AS65L</b>	D-	S-			697 €	762 €	834 €	834 €
67↔69	65,4↔67,4	37	29	83	62	37	<b>Y22AS67L</b>	D-	S-			697 €	762 €	834 €	834 €
69↔71	67,4↔69,4	38	30	86	64	38	<b>Y22AS69L</b>	D-	S-			697 €	762 €	834 €	834 €
73↔75	71,4↔73,4	40	32	92	68	40	<b>Y22AS73L</b>	D-	S-			709 €	775 €	848 €	848 €
75↔77	73,4↔75,4	41	33	95	70	41	<b>Y22AS75L</b>	D-	S-			709 €	775 €	848 €	848 €
76↔78	74,4↔76,4	42	33	96	71	42	<b>Y22AS76L</b>	D-	S-			709 €	775 €	848 €	848 €
77↔79	75,4↔77,4	42	34	97	72	42	<b>Y22AS77L</b>	D-	S-			709 €	775 €	848 €	848 €
79↔81	77,4↔79,4	43	35	100	74	43	<b>Y22AS79L</b>	D-	S-			709 €	775 €	848 €	848 €
81↔83	79,4↔81,4	44	36	103	76	44	<b>Y22AS81L</b>	D-	S-			729 €	795 €	867 €	867 €
85↔87	83,4↔85,4	46	38	109	80	46	<b>Y22AS85L</b>	D-	S-	+38 €		729 €	795 €	867 €	867 €
87↔89	85,4↔87,4	47	39	112	82	47	<b>Y22AS87L</b>	D-	S-			729 €	795 €	867 €	867 €
89↔91	87,4↔89,4	48	40	115	84	48	<b>Y22AS89L</b>	D-	S-			729 €	795 €	867 €	867 €
91↔93	89,4↔91,4	49	41	117	86	49	<b>Y22AS91L</b>	D-	S-			735 €	808 €	887 €	887 €
95↔97	93,4↔95,4	51	43	123	90	51	<b>Y22AS95L</b>	D-	S-			735 €	808 €	887 €	887 €
97↔99	95,4↔97,4	52	44	126	92	52	<b>Y22AS97L</b>	D-	S-			735 €	808 €	887 €	887 €
99↔101	97,4↔99,4	53	45	129	94	53	<b>Y22AS99L</b>	D-	S-			735 €	808 €	887 €	887 €
101↔103	99,4↔101,4	54	46	131	96	54	<b>Y22AS101L</b>	D-	S-			755 €	828 €	907 €	907 €
105↔107	103,4↔105,4	56	48	137	100	56	<b>Y22AS105L</b>	D-	S-			755 €	828 €	907 €	907 €
115↔117	113,4↔115,4	61	53	151	110	61	<b>Y22AS115L</b>	D-	S-			775 €	848 €	927 €	927 €
117↔119	115,4↔117,4	62	54	154	112	62	<b>Y22AS117L</b>	D-	S-			775 €	848 €	927 €	927 €
119↔121	117,4↔119,4	63	55	157	114	63	<b>Y22AS119L</b>	D-	S-			775 €	848 €	927 €	927 €

### OPTIONAL



**GUARNIZIONE INFERIORE ORIZZONTALE**  
PER MONTAGGIO SENZA PROFILO INFERIORE DI TENUTA

Codice	Prezzo
<b>R55SPBOM01-TR</b>	43 €

**PER COMPORRE UN ANGOLO, ORDINARE 2 LATI (LATO DESTRO + LATO SINISTRO)**

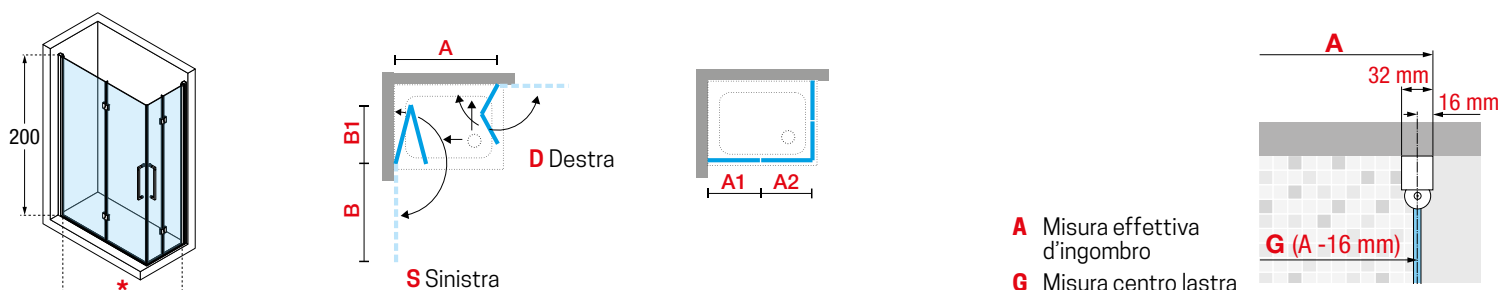

**A** Misura effettiva d'ingombro  
**G** Misura centro lastra

056 Costruzione del codice **Codice** + **Sinistra/Destra** + **Vetro** + **Profilo** = Codice prodotto finale



CERNIERE AVVITATE



GUARNIZIONE VERTICALE PORTA

**FINITURE VETRI**



Trasparente  
cod 1



Aqua  
cod 2

**FINITURE PROFILI**



Bianco opaco  
cod U

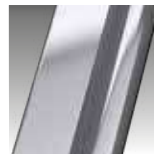

Silver  
cod B



Cromo  
cod K



Nero opaco  
cod H

# YOUNG 3AS



## BOX DOCCIA AD ANGOLO APERTURA 2 ANTE RIPIEGABILI A SOFFIETTO CON DUE ANTE FISSE

Misure								Codice	Destra	Sinistra	Scelta vetro		Scelta profilo			
Misura effettiva d'ingombro	Misura centro lastra	Ante			Entrata	Ingombro ante esterno	Ingombro ante interno				1	2	U	B	K	H
A	G	F1	A1	A2	*	B	B1									
117↔119	115,4↔117,4	22	50	46	131	95	50	<b>Y23AS117L</b>	D-	S-	Trasparente	Aqua	Bianco opaco	Silver	Cromo	Nero opaco
119↔121	117,4↔119,4	22	51	47	134	97	51	<b>Y23AS119L</b>	D-	S-			945 €	1.044 €	1.149 €	1.149 €
121↔123	119,4↔121,4	22	52	48	137	99	52	<b>Y23AS121L</b>	D-	S-			945 €	1.044 €	1.149 €	1.149 €
125↔127	123,4↔125,4	22	54	50	143	103	54	<b>Y23AS125L</b>	D-	S-			945 €	1.044 €	1.149 €	1.149 €
127↔129	125,4↔127,4	22	55	51	145	105	55	<b>Y23AS127L</b>	D-	S-			945 €	1.044 €	1.149 €	1.149 €
129↔131	127,4↔129,4	22	56	52	148	107	56	<b>Y23AS129L</b>	D-	S-			945 €	1.044 €	1.149 €	1.149 €
131↔133	129,4↔131,4	22	57	53	151	109	57	<b>Y23AS131L</b>	D-	S-			972 €	1.070 €	1.175 €	1.175 €
135↔137	133,4↔135,4	26	57	53	151	109	57	<b>Y23AS135L</b>	D-	S-			972 €	1.070 €	1.175 €	1.175 €
137↔139	135,4↔137,4	28	57	53	151	109	57	<b>Y23AS137L</b>	D-	S-			979 €	1.077 €	1.182 €	1.182 €
139↔141	137,4↔139,4	30	57	53	151	109	57	<b>Y23AS139L</b>	D-	S-			985 €	1.084 €	1.189 €	1.189 €
141↔143	139,4↔141,4	32	57	53	151	109	57	<b>Y23AS141L</b>	D-	S-			992 €	1.090 €	1.195 €	1.195 €
145↔147	141,4↔145,4	36	57	53	151	109	57	<b>Y23AS145L</b>	D-	S-			998 €	1.097 €	1.202 €	1.202 €
147↔149	145,4↔147,4	38	57	53	151	109	57	<b>Y23AS147L</b>	D-	S-			1.005 €	1.103 €	1.215 €	1.215 €
149↔151	147,4↔149,4	40	57	53	151	109	57	<b>Y23AS149L</b>	D-	S-			1.005 €	1.103 €	1.215 €	1.215 €
151↔153	149,4↔151,4	42	57	53	151	109	57	<b>Y23AS151L</b>	D-	S-			1.012 €	1.110 €	1.222 €	1.222 €
155↔157	153,4↔155,4	46	57	53	151	109	57	<b>Y23AS155L</b>	D-	S-			1.018 €	1.117 €	1.228 €	1.228 €
157↔159	155,4↔157,4	48	57	53	151	109	57	<b>Y23AS157L</b>	D-	S-			1.024 €	1.129 €	1.242 €	1.242 €
159↔161	157,4↔159,4	50	57	53	151	109	57	<b>Y23AS159L</b>	D-	S-			1.024 €	1.129 €	1.242 €	1.242 €

### OPTIONAL



**GUARNIZIONE INFERIORE ORIZZONTALE**  
PER MONTAGGIO SENZA PROFILO INFERIORE DI TENUTA

Codice	Prezzo
<b>R55SPBOM01-TR</b>	43 €

### PER COMPORRE UN ANGOLO, ORDINARE 2 LATI (LATO DESTRO + LATO SINISTRO)

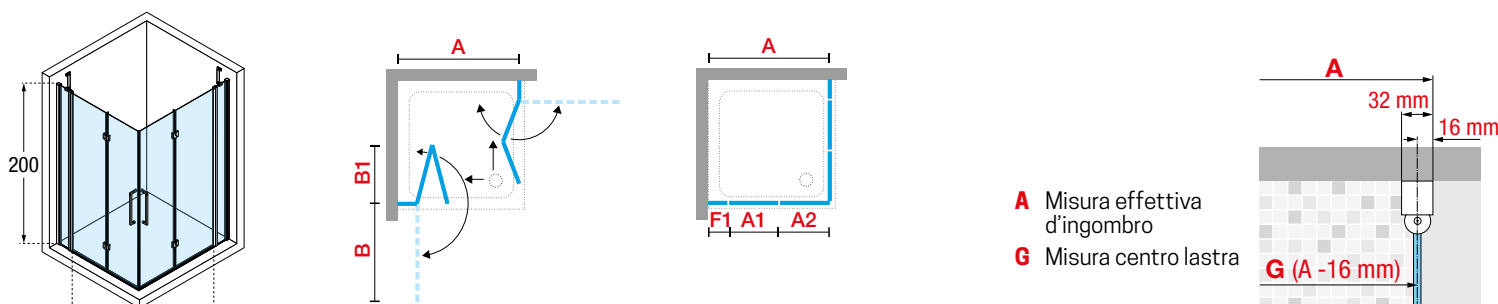

**A** Misura effettiva d'ingombro  
**G** Misura centro lastra



CERNIERE AVVITATE



GUARNIZIONE VERTICALE PORTA

**FINITURE VETRI**



Trasparente  
cod 1



Aqua  
cod 2

**FINITURE PROFILI**



Bianco opaco  
cod U

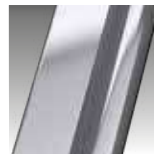

Silver  
cod B



Cromo  
cod K



Nero opaco  
cod H

## BOX DOCCIA AD ANGOLO APERTURA 2 ANTE A BATTENTE E 2 FISSE IN LINEA

Misure					Codice	Scelta vetro			Scelta profilo					
Misura effettiva d'ingombro	Misura centro lastra	Anta fissa	Entrata (cm)	Ingombro anta esterno		1	2	4	U	B	K	H		
A	G	F1	*	B		Trasparente	Aqua	Satin	Bianco opaco	Silver	Cromo	Nero opaco		
57↔59	55,4↔57,4	27	37	27	<b>Y2A57L-</b>				444 €	489 €	539 €	539 €		
59↔61	57,4↔59,4	27	39	29	<b>Y2A59L-</b>				444 €	489 €	539 €	539 €		
61↔63	59,4↔61,4	27	42	31	<b>Y2A61L-</b>				444 €	489 €	539 €	539 €		
65↔67	63,4↔65,4	27	48	35	<b>Y2A65L-</b>				444 €	489 €	539 €	539 €		
67↔69	65,4↔67,4	27	51	37	<b>Y2A67L-</b>				465 €	512 €	564 €	564 €		
69↔71	67,4↔69,4	27	54	39	<b>Y2A69L-</b>				465 €	512 €	564 €	564 €		
73↔75	71,4↔73,4	35	49	35	<b>Y2A73L-</b>				465 €	512 €	564 €	564 €		
75↔77	73,4↔75,4	35	51	37	<b>Y2A75L-</b>				465 €	512 €	564 €	564 €		
76↔78	74,4↔76,4	35	52	38	<b>Y2A76L-</b>				465 €	512 €	564 €	564 €		
77↔79	75,4↔77,4	35	54	39	<b>Y2A77L-</b>				487 €	537 €	590 €	590 €		
79↔81	77,4↔79,4	35	57	41	<b>Y2A79L-</b>				487 €	537 €	590 €	590 €		
81↔83	79,4↔81,4	35	59	43	<b>Y2A81L-</b>				487 €	537 €	590 €	590 €		
85↔87	83,4↔85,4	43	54	39	<b>Y2A85L-</b>				487 €	537 €	590 €	590 €		
87↔89	85,4↔87,4	43	57	41	<b>Y2A87L-</b>				487 €	537 €	590 €	590 €		
89↔91	87,4↔89,4	43	60	43	<b>Y2A89L-</b>				509 €	562 €	618 €	618 €		
91↔93	89,4↔91,4	43	62	45	<b>Y2A91L-</b>				509 €	562 €	618 €	618 €		
95↔97	93,4↔95,4	43	69	49	<b>Y2A95L-</b>				509 €	562 €	618 €	618 €		
97↔99	95,4↔97,4	43	72	51	<b>Y2A97L-</b>				509 €	562 €	618 €	618 €		
99↔101	97,4↔99,4	43	75	53	<b>Y2A99L-</b>				509 €	562 €	618 €	618 €		
101↔103	99,4↔101,4	43	77	55	<b>Y2A101L-</b>				509 €	562 €	618 €	618 €		
H 140↔220 L 57↔118				SPECIAL	<b>Y2ALSP</b>				+ 38 €	+ 38 €	658 €	723 €	797 €	797 €

### PER COMPORRE UN ANGOLO ORDINARE 2 LATI BARRE DI SOSTEGNO AD ANGOLO, IN DOTAZIONE

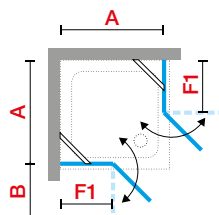
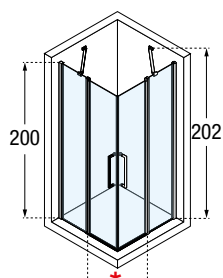

#### OPTIONAL

**GUARNIZIONE INFERIORE ORIZZONTALE**  
PER MONTAGGIO SENZA PROFILO INFERIORE DI TENUTA, 100 CM

Codice	Prezzo
<b>R55SPBOA01-TR</b>	43 €

**A** Misura effettiva d'ingombro  
**G** Misura centro lastra

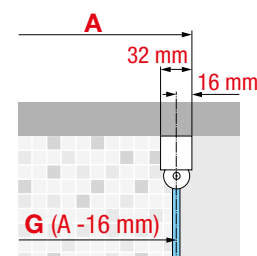



**FINITURE VETRI**



Trasparente  
cod 1

Aqua  
cod 2

Satin  
cod 4

**FINITURE PROFILI**

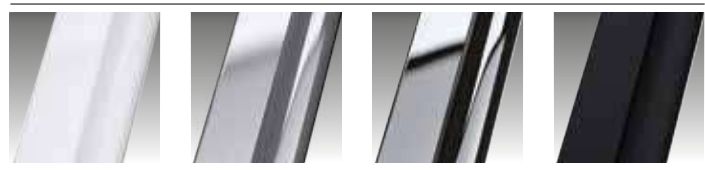

Bianco opaco  
cod U

Silver  
cod B

Cromo  
cod K

Nero opaco  
cod H

# YOUNG 2A



PORTA DOCCIA APERTURA 2 ANTE BATTENTI E 2 FISSE IN LINEA, IN NICCHIA



## FINITURE VETRI



Trasparente  
cod 1

Aqua  
cod 2



Satin  
cod 4

## FINITURE PROFILI



Bianco opaco  
cod U

Silver  
cod B



Cromo  
cod K

Nero opaco  
cod H

Misure				Codice	Scelta vetro			Scelta profilo			
Misura effettiva d'ingombro	Anta fissa	Entrata (cm)	Ingombro anta esterno		1	2	4	U	B	K	H
<b>A</b>	<b>F1</b>	*	<b>B</b>		Trasparente	Aqua	Satinato	Bianco opaco	Silver	Cromo	Nero opaco
97↔101	25	43	22	<b>Y22A97-</b>				883 €	972 €	1.069 €	1.069 €
117↔121	30	53	27	<b>Y22A117-</b>				883 €	972 €	1.069 €	1.069 €
137↔141	36	61	31	<b>Y22A137-</b>				924 €	1.017 €	1.120 €	1.120 €
147↔151	37	69	35	<b>Y22A147-</b>		+ 76 €	+ 76 €	924 €	1.017 €	1.120 €	1.120 €
157↔161	40	73	37	<b>Y22A157-</b>				975 €	1.075 €	1.183 €	1.183 €
167↔171	43	77	39	<b>Y22A167-</b>				975 €	1.075 €	1.183 €	1.183 €
177↔181	45	81	41	<b>Y22A177-</b>				1.017 €	1.120 €	1.232 €	1.232 €

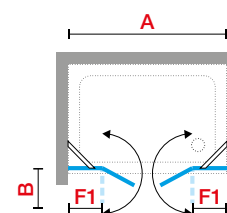
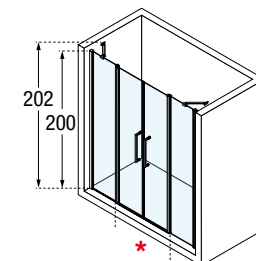

**2 BARRE DI SOSTEGNO AD ANGOLO, IN DOTAZIONE**

## OPTIONAL



**GUARNIZIONE INFERIORE ORIZZONTALE**  
PER MONTAGGIO SENZA PROFILO INFERIORE DI TENUTA, 100 CM

Codice	Prezzo
<b>R55SPB02A1-TR</b>	25 €



# YOUNG R2



BOX DOCCIA AD ANGOLO SEMICIRCOLARE, APERTURA 2 ANTE BATTENTI E 2 FISSE



## FINITURE VETRI



Traspirente  
cod 1

Aqua  
cod 2



Satin  
cod 4

## FINITURE PROFILI



Bianco opaco  
cod U

Silver  
cod B



Cromo  
cod K

Nero opaco  
cod H

Misure					Codice	Scelta vetro			Scelta profilo			
Misura effettiva d'ingombro	Misura centro lastra	Anta fissa	Entrata (cm)	Ingombro anta esterno		1	2	4	U	B	K	H
<b>A</b>	<b>G</b>	<b>F1</b>	*	<b>B</b>		Traspa- rente	Aqua	Satin	Bianco opaco	Silver	Cromo	Nero opaco
77,5↔79,5	75,9↔77,9	22	71	38	<b>Y2R80-</b>				1.299 €	1.429 €	1.573 €	1.573 €
87,5↔89,5	85,9↔87,9	32	71	38	<b>Y2R90-</b>		+ 76 €	+ 76 €	1.299 €	1.429 €	1.573 €	1.573 €
97,5↔99,5	95,9↔97,9	42	71	38	<b>Y2R100-</b>				1.299 €	1.429 €	1.573 €	1.573 €

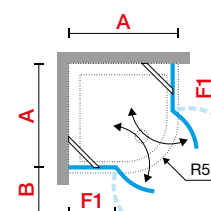
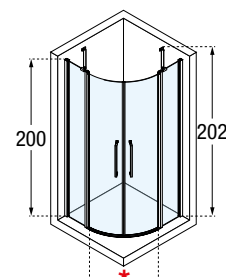

2 BARRE DI SOSTEGNO AD ANGOLO, IN DOTAZIONE

## OPTIONAL



**GUARNIZIONE INFERIORE ORIZZONTALE**  
PER MONTAGGIO SENZA PROFILO INFERIORE DI TENUTA, 100 CM

Codice	Prezzo
<b>R55SPBOR01-TR</b>	54 €

**A**  
Misura effettiva d'ingombro

**G**  
Misura centro lastra

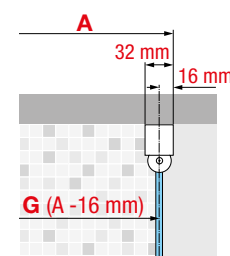

Costruzione del codice

Codice + Sinistra/Destra + Vetro + Profilo = Codice prodotto finale

# YOUNG R2 LUX



BOX DOCCIA AD ANGOLO SEMICIRCOLARE, APERTURA 2 ANTE BATTENTI



## FINITURE VETRI



Trasparente  
cod 1

Aqua  
cod 2

## FINITURE PROFILI



Bianco opaco  
cod U

Silver  
cod B



Cromo  
cod K

Nero opaco  
cod H

Misure				Codice	Scelta vetro		Scelta profilo			
Misura effettiva d'ingombro	Misura centro lastra	Entrata (cm)	Ingombro anta esterno		1	2	U	B	K	H
<b>A</b>	<b>G</b>	*	<b>B</b>		Trasparente	Aqua	Bianco opaco	Silver	Cromo	Nero opaco
77,5↔79,5	75,9↔77,9	98	56	<b>Y2R280-</b>			1.363 €	1.500 €	1.650 €	1.650 €
87,5↔89,5	85,9↔87,9	112	66	<b>Y2R290-</b>		+ 76 €	1.363 €	1.500 €	1.650 €	1.650 €
97,5↔99,5	95,9↔97,9	126	76	<b>Y2R2100-</b>			1.363 €	1.500 €	1.650 €	1.650 €

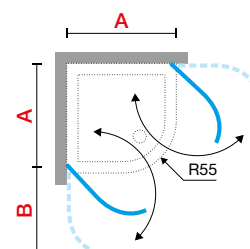
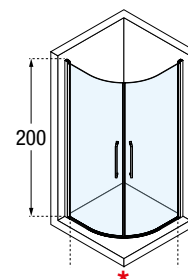

## OPTIONAL



**GUARNIZIONE INFERIORE ORIZZONTALE**  
PER MONTAGGIO SENZA PROFILO INFERIORE DI TENUTA, 100 CM

Codice	Prezzo
<b>R55SPBOR01-TR</b>	54 €

**A**  
Misura effettiva d'ingombro

**G**  
Misura centro lastra

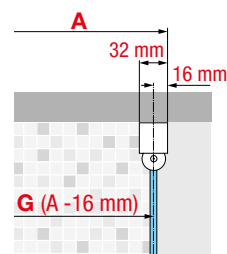

# YOUNG R1



BOX DOCCIA AD ANGOLO SEMICIRCOLARE, APERTURA 1 ANTA BATTENTE E 2 FISSE



## FINITURE VETRI

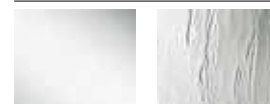

Trasparente  
cod 1

Aqua  
cod 2

## FINITURE PROFILI



Bianco opaco  
cod U

Silver  
cod B



Cromo  
cod K

Nero opaco  
cod H

Misure						Codice	Scelta vetro		Scelta profilo			
Misura effettiva d'ingombro	Misura centro lastra	Fisso in linea		Entrata (cm)	Ingombro anta esterno		1	2	U	B	K	H
<b>A</b>	<b>G</b>	<b>F1</b>	<b>F2</b>	<b>*</b>	<b>B</b>		Trasparente	Aqua	Bianco opaco	Silver	Cromo	Nero opaco
77,5↔79,5	75,9↔77,9	22	23	72	73	<b>Y2R1A80-</b>			1.299 €	1.429 €	1.573 €	1.573 €
87,5↔89,5	85,9↔87,9	32	33	72	73	<b>Y2R1A90-</b>		+ 76 €	1.299 €	1.429 €	1.573 €	1.573 €
97,5↔99,5	95,9↔97,9	42	43	72	73	<b>Y2R1A100-</b>			1.299 €	1.429 €	1.573 €	1.573 €

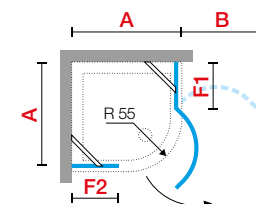
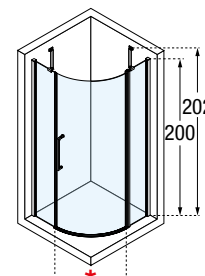

## 2 BARRE DI SOSTEGNO AD ANGOLO, IN DOTAZIONE

### OPTIONAL



**GUARNIZIONE INFERIORE ORIZZONTALE**  
PER MONTAGGIO SENZA PROFILO INFERIORE DI TENUTA, 100 CM

Codice	Prezzo
<b>R55SPBOR11-TR</b>	54 €

**A**  
Misura effettiva d'ingombro

**G**  
Misura centro lastra

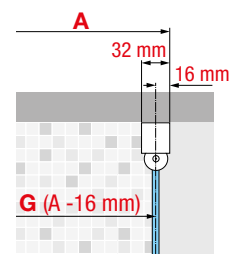

Costruzione del codice + Codice + Vetro + Profilo = Codice prodotto finale

# YOUNG R



BOX DOCCIA AD ANGOLO SEMICIRCOLARE ASIMMETRICO, APERTURA 1 ANTA BATTENTE E 2 FISSE



## FINITURE VETRI

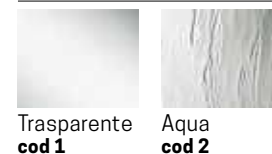

## FINITURE PROFILI



Misure					Codice	Scelta vetro		Scelta profilo			
Misura effettiva d'ingombro	Misura centro lastra	Anta fissa	Entrata (cm)	Ingombro anta esterno		1	2	U	B	K	H
<b>A</b>	<b>G</b>	<b>F1 F2</b>	<b>*</b>	<b>B</b>		Trasparente	Aqua	Bianco opaco	Silver	Cromo	Nero opaco
67,5↔69,5 x 87,5↔89,5	65,9↔67,9 x 85,9↔87,9	30 49	48	49	<b>Y2R1A7090-</b>			1.299 €	1.429 €	1.573 €	1.573 €
77,5↔79,5 x 97,5↔99,5	75,9↔77,9 x 95,9↔97,9	40 59	48	49	<b>Y2R1A80100-</b>	+ 76 €		1.299 €	1.429 €	1.573 €	1.573 €
77,5↔79,5 x 117,5↔119,5	75,9↔77,9 x 115,9↔117,9	40 79	48	49	<b>Y2R1A80120-</b>			1.299 €	1.429 €	1.573 €	1.573 €

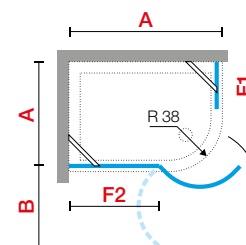
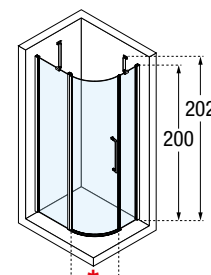

2 BARRE DI SOSTEGNO AD ANGOLO, IN DOTAZIONE

## OPTIONAL



**GUARNIZIONE INFERIORE ORIZZONTALE**  
PER MONTAGGIO SENZA PROFILO INFERIORE DI TENUTA, 100 CM

Codice	Prezzo
<b>R55SPBOR11-TR</b>	54 €

**A**  
Misura effettiva d'ingombro

**G**  
Misura centro lastra

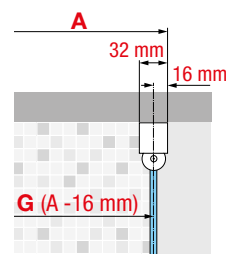

# YOUNG F SPECIAL 2

## PARETE FISSA SPECIALE, SAGOMATA 5 LATI

Compatibile con porte YOUNG 2.0 G e 2GS



### FINITURE VETRI



Trasparente  
cod 1

Aqua  
cod 2



Satin  
cod 4

### FINITURE PROFILI



Bianco opaco  
cod U

Silver  
cod B



Cromo  
cod K

Nero opaco  
cod H

Misura	Codice	Scelta vetro			Scelta profilo			
		1	2	4	U	B	K	H
Misura effettiva d'ingombro		Trasparente	Aqua	Satin	Bianco opaco	Silver	Cromo	Nero opaco
<b>F</b>								
H 155↕200 L 38↔120	<b>Y2F2SP</b>	+ 38 €	+ 38 €	558 €	615 €	677 €	677 €	

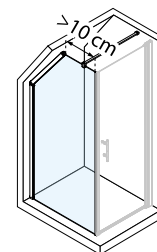

Sinistra

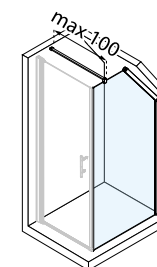

Destra

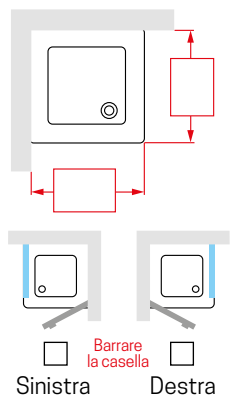
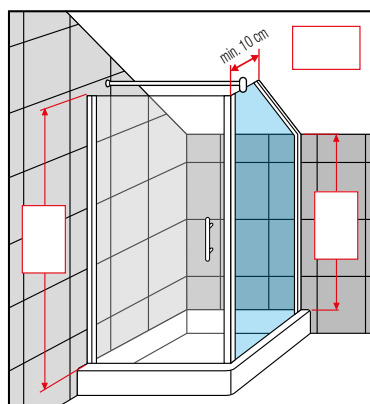

PER LA FATTIBILITÀ DELLE MISURE SPECIALI CONTATTARE IL SERVIZIO CLIENTI O CONSULTARE [HTTP://STORE.NOVELLINI.COM](http://store.novellini.com)  
BARRA DI SOSTEGNO 150 CM IN DOTAZIONE

Costruzione del codice **Codice** + **Vetro** + **Profilo** = Codice prodotto finale

# YOUNG F SPECIAL 3

**PARETE FISSA SPECIALE, SAGOMATA 6 LATI**

Compatibile con porte YOUNG 2.0 G e 2GS



6 mm



2 cm



## FINITURE VETRI



Trasparente  
cod 1



Aqua  
cod 2



Satin  
cod 4

## FINITURE PROFILI



Bianco opaco  
cod U



Silver  
cod B



Cromo  
cod K



Nero opaco  
cod H

Misure	Codice	Scelta vetro			Scelta profilo			
Misura effettiva d'ingombro		1	2	4	U	B	K	H
<b>A</b>		Trasparente	Aqua	Satinato	Bianco opaco	Silver	Cromo	Nero opaco
H 140±200 L 60↔120	<b>Y2F3SP</b>		+ 38 €	+ 38 €	603 €	663 €	729 €	729 €

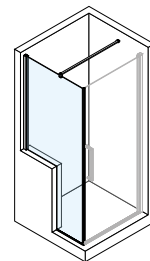

Sinistra

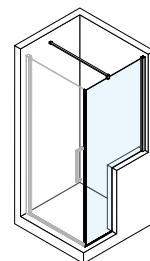

Destra

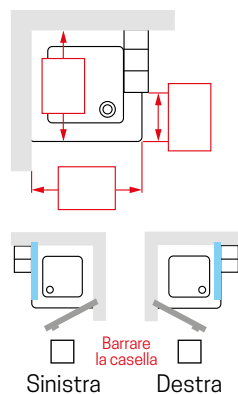
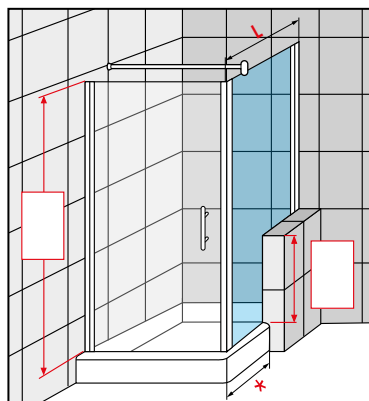

\*  $\geq L/3$ : LA QUOTA DI \* DEVE ESSERE MAGGIORE DI 1/3 DELLA LUCE SUPERIORE E COMUNQUE NON INFERIORE A 20 cm.

**PER LA FATTIBILITÀ DELLE MISURE SPECIALI CONTATTARE IL SERVIZIO CLIENTI O CONSULTARE [HTTP://STORE.NOVELLINI.COM](http://store.novellini.com)  
BARRA DI SOSTEGNO 150 CM IN DOTAZIONE**

# YOUNG F SPECIAL 4



6 mm



2 cm



**PARETE FISSA SPECIALE, PER INSTALLAZIONE SU MURETTO, SPECIALE IN LARGHEZZA ED ALTEZZA**

Compatibile con porte YOUNG 2.0 1BS, 1B, G+F in linea e 2P



## FINITURE VETRI



Trasparente  
cod 1



Aqua  
cod 2



Satin  
cod 4

## FINITURE PROFILI



Bianco opaco  
cod U



Silver  
cod B



Cromo  
cod K



Nero opaco  
cod H

Misura	Codice	Scelta vetro			Scelta profilo			
		1	2	4	U	B	K	H
Misura effettiva d'ingombro		Trasparente	Aqua	Satin	Bianco opaco	Silver	Cromo	Nero opaco
<b>F</b>								
H 65±200 L 20↔120	<b>Y2F4SP</b>		+ 38 €	+ 38 €	525 €	578 €	635 €	635 €

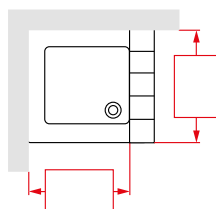
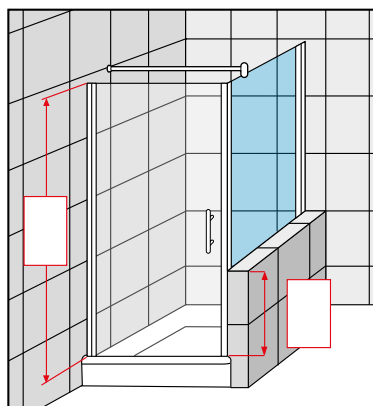
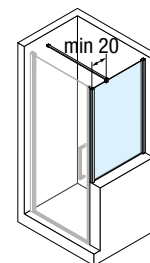

**PER LA FATTIBILITÀ DELLE MISURE SPECIALI CONTATTARE IL SERVIZIO CLIENTI O CONSULTARE [HTTP://STORE.NOVELLINI.COM](http://store.novellini.com)  
BARRA DI SOSTEGNO 150 CM IN DOTAZIONE**

Costruzione del codice + Vetro + Profilo = Codice prodotto finale

OPTIONAL



**BARRA DI SOSTEGNO AD ANGOLO**

Finitura	Misure	Codice	Prezzo
Bianco opaco	25 cm	<b>R80LOU250-U</b>	72 €
Cromo		<b>R80LOU250-K</b>	72 €
Nero opaco		<b>R80LOU250-H</b>	72 €
Bianco opaco	35 cm	<b>R80LOU350-U</b>	78 €
Cromo		<b>R80LOU350-K</b>	78 €
Nero opaco		<b>R80LOU350-H</b>	78 €
Bianco opaco	45 cm	<b>R80LOU450-U</b>	85 €
Cromo		<b>R80LOU450-K</b>	85 €
Nero opaco		<b>R80LOU450-H</b>	85 €



**BARRA DI SOSTEGNO 200 cm (accorciabile)**

Finitura	Codice	Prezzo
Bianco opaco	<b>R80Y220-U</b>	69 €
Silver	<b>R80Y220-B</b>	75 €
Cromo	<b>R80Y220-K</b>	82 €
Nero opaco	<b>R80Y220-H</b>	82 €



**KIT BARRA ORIENTABILE**

- 1 barra orientabile da 100 cm (accorciabile)
- 1 attacco a muro
- 1 morsetto di fissaggio al vetro

Finitura	Misure	Codice	Prezzo
Bianco opaco	100 cm	<b>R80KUOR100-U</b>	105 €
Silver		<b>R80KUOR100-B</b>	117 €
Cromo		<b>R80KUOR100-K</b>	127 €
Nero opaco		<b>R80KUOR100-H</b>	127 €



**KIT BARRA A "T" (accorciabile)**

barra di sostegno 150 cm da abbinare con la barra in dotazione per soluzione a "T"

Finitura	Codice	Prezzo
Bianco opaco	<b>R80Y215T-U</b>	90 €
Silver	<b>R80Y215T-B</b>	98 €
Cromo	<b>R80Y215T-K</b>	108 €
Nero opaco	<b>R80Y215T-H</b>	108 €



**GUARNIZIONE INFERIORE ORIZZONTALE - L. 100 cm**

PER MONTAGGIO SENZA PROFILO INFERIORE DI TENUTA

PER YOUNG 2A - 2B

Codice	Prezzo
<b>R55SPB02A1-TR</b>	25 €

PER YOUNG A / 2G / 2GS

Codice	Prezzo
<b>R55SPB0A01-TR</b>	43 €

PER YOUNG 1B - 1BS - 2P - G

Codice	Prezzo
<b>R55SPB0M01-TR</b>	43 €



**GUARNIZIONE INFERIORE ORIZZONTALE**

PER MONTAGGIO SENZA PROFILO INFERIORE DI TENUTA

PER YOUNG R2, R2LUX

Codice	Prezzo
<b>R55SPBOR01-TR</b>	54 €

PER YOUNG R, R1

Codice	Prezzo
<b>R55SPBOR11-TR</b>	54 €



## DATI TECNICI

### FINITURE PROFILI



Bianco opaco  
cod. U

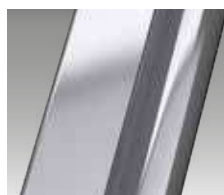

Silver  
cod. B



Cromo  
cod. K



Nero opaco  
cod. H



### VETRO TEMPRATO 6 mm (European Standards EN 14428)



Trasparente  
cod. 1



Aqua  
cod. 2



Satin  
cod. 4

### MANIGLIA



Maniglia cromata

### OPTIONAL



Maniglia cromata

Finitura	Codice	Prezzo
Cromo	R40EIMAY21-K	88 €
Nero	R40EIMAY21-H	88 €

### MISURE DI INGOMBRO PROFILI DI FISSAGGIO

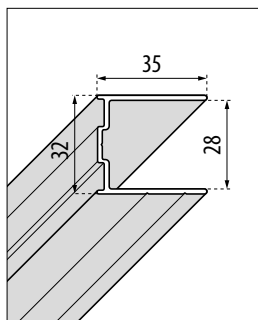

#### A MURO

Altezza	Finitura	Codice
1984	Bianco opaco	P01BNMOBST-U
	Silver	P01BNMOBST-B
	Cromo	P01BNMOBST-K
	Nero opaco	P01BNMOBST-H
2000	Bianco	P01BNMOAST-U
	Silver	P01BNMOAST-B
	Cromo	P01BNMOAST-K
	Nero	P01BNMOAST-H

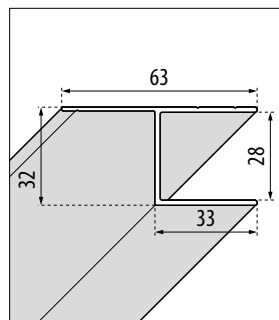

#### A MURO (OPTIONAL)

fissaggio a muro laterale

Altezza	Finitura	Codice
1984	Bianco opaco	P01Y2MOBSTL-U
	Silver	P01Y2MOBSTL-B
	Cromo	P01Y2MOBSTL-K
	Nero opaco	P01Y2MOBSTL-H
2000	Bianco	P01Y2MOASTL-U
	Silver	P01Y2MOASTL-B
	Cromo	P01Y2MOASTL-K
	Nero	P01Y2MOASTL-H

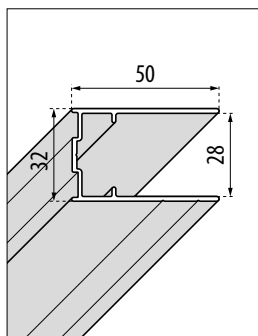

#### COMPENSATIVI (OPTIONAL)

in sostituzione del profilo a muro +15 mm

Altezza	Finitura	Codice
1984	Bianco opaco	P05Y2ST-U
	Silver	P05Y2ST-B
	Cromo	P05Y2ST-K
	Nero opaco	P05Y2ST-H
2000	Bianco	P05Y2ST2-U
	Silver	P05Y2ST2-B
	Cromo	P05Y2ST2-K
	Nero	P05Y2ST2-H

### COME RILEVARE LE MISURE

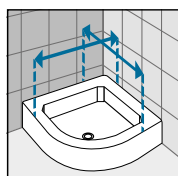
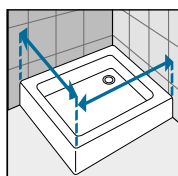

Rilevare le misure da muro a bordo esterno del piatto doccia. Le misure devono essere rilevate sulla parete finita, a rivestimenti posati, secondo gli schemi riportati.

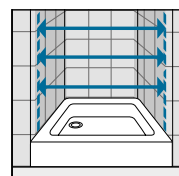

Rilevare le misure da muro a muro, in basso, in alto, al centro e utilizzare quella di valore inferiore. Le misure devono essere rilevate sulla parete finita, a rivestimenti posati, secondo gli schemi riportati.

# GALA

L'ESSENZIALITÀ DEL VETRO.  
LA QUALITÀ SENZA COMPROMESSI.



◀ Cerniere regolabili  
in metallo cromato



◀ Vetri sempre paralleli



◀ Maniglia e cerniere  
design Marco Pellici

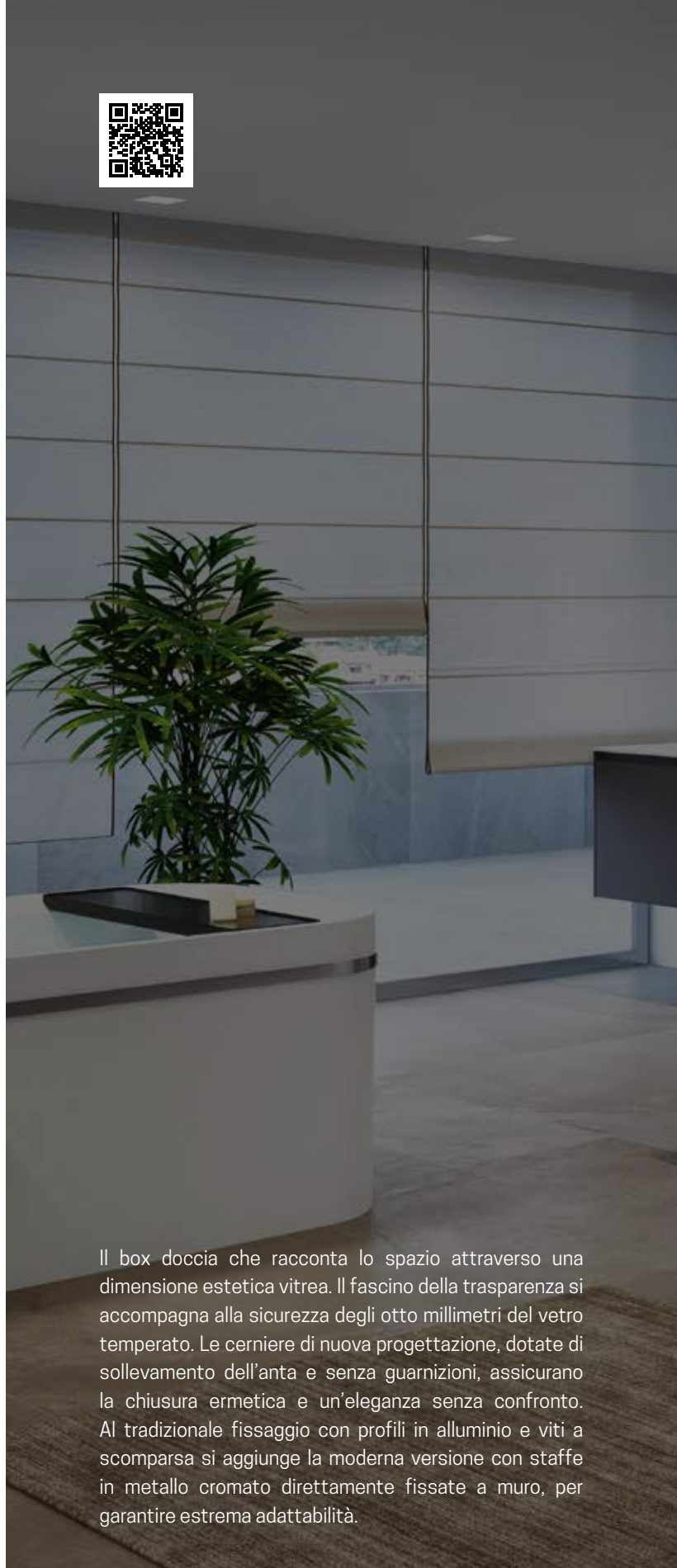

Il box doccia che racconta lo spazio attraverso una dimensione estetica vitrea. Il fascino della trasparenza si accompagna alla sicurezza degli otto millimetri del vetro temperato. Le cerniere di nuova progettazione, dotate di sollevamento dell'anta e senza guarnizioni, assicurano la chiusura ermetica e un'eleganza senza confronto. Al tradizionale fissaggio con profili in alluminio e viti a scomparsa si aggiunge la moderna versione con staffe in metallo cromato direttamente fissate a muro, per garantire estrema adattabilità.

## TRATTAMENTI





# GALA

# GALA 2P+F

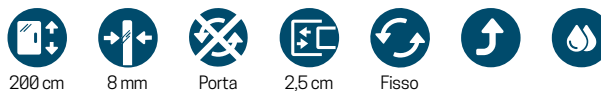

## BOX DOCCIA AD ANGOLO, APERTURA 1 ANTA BATTENTE E 1 FISSO IN LINEA CON 1 PARETE FISSA LATERALE

Design Marco Pellici

Misure							Codice	Destra	Sinistra	Scelta vetro	Scelta profilo
Misura effettiva d'ingombro	Misura centro lastra	Fisso frontale	Entrata (cm)		Ingombro anta esterno			D-	S-	1	K
			Min.	Max.	Min.	Max.					
<b>A</b>	<b>G</b>	<b>F1</b>	*	*	<b>B</b>	<b>B</b>				Trasparente	Cromo
<b>PORTA</b>											
113,5↔116	112,5↔115	55	51	53	54	57	<b>GALA12PF115</b>	D-	S-		1.332 €
116↔118,5	115↔117,5	58	51	53	54	57	<b>GALA12PF120</b>	D-	S-		1.470 €
136↔138,5	135↔137,5	68	61	63	64	67	<b>GALA12PF140</b>	D-	S-		1.612 €
156↔158,5	155↔157,5	78	71	73	74	77	<b>GALA12PF160</b>	D-	S-		1.752 €
176↔178,5	175↔177,5	88	81	83	84	87	<b>GALA12PF180</b>	D-	S-		1.890 €
H 150↑210 L 113,5↔180					SPECIAL		<b>GALA12PFSP</b>	-	-		2.097 €
<b>PARETE FISSA</b>											
<b>F</b>	<b>G</b>										
66↔68,5	65↔67,5	-	-	-	-	-	<b>GALA1F70-</b>				603 €
71↔73,5	70↔72,5	-	-	-	-	-	<b>GALA1F75-</b>				633 €
76↔78,5	75↔77,5	-	-	-	-	-	<b>GALA1F80-</b>				660 €
86↔88,5	85↔87,5	-	-	-	-	-	<b>GALA1F90-</b>	-	-		688 €
96↔98,5	95↔97,5	-	-	-	-	-	<b>GALA1F100-</b>				717 €
106↔108,5	105↔107,5	-	-	-	-	-	<b>GALA1F110-</b>				744 €
116↔118,5	115↔117,5	-	-	-	-	-	<b>GALA1F120-</b>				772 €
H 150↑210 L 26↔121					SPECIAL		<b>GALA1FSP</b>	-	-		839 €

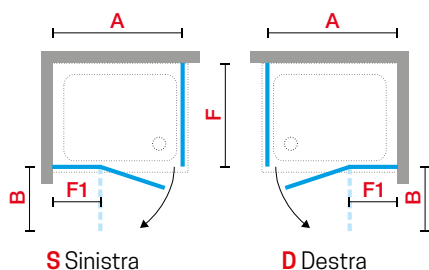
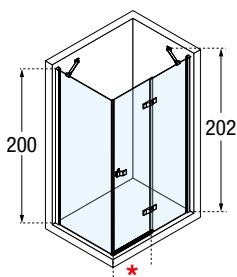

**A**  
Misura effettiva d'ingombro

**G**  
Misura centro lastra

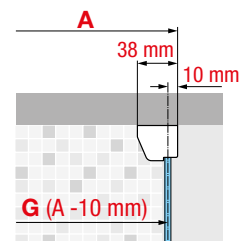

074



Costruzione del codice

Codice + Sinistra/Destra + Vetro + Profilo = Codice prodotto finale



**FINITURE VETRI**



Trasparente  
cod 1

**FINITURE PROFILI**



Cromo  
cod K

# GALA 2P



200 cm



8 mm



2,5 cm



## PORTA DOCCIA, APERTURA 1 ANTA BATTENTE E 1 FISSA IN LINEA, IN NICCHIA

Design Marco Pellici



### FINITURE VETRI



Trasparente  
cod 1

### FINITURE PROFILI



Cromo  
cod K

Misure						Codice	Destra	Sinistra	Scelta vetro	Scelta profilo
Misura effettiva d'ingombro	Fisso frontale	Entrata (cm)		Ingombro anta esterno						
		Min.	Max.	Min.	Max.	D-	S-	1	K	
<b>A</b>	<b>F1</b>	*	*	<b>B</b>	<b>B</b>				Trasparente	Cromo
114,5↔117	55	51	53	54	57	<b>GALA12P115</b>	D-	S-		1.402 €
117↔119,5	58	51	53	54	57	<b>GALA12P120</b>	D-	S-		1.540 €
137↔139,5	68	61	63	64	67	<b>GALA12P140</b>	D-	S-		1.680 €
157↔159,5	78	71	73	74	77	<b>GALA12P160</b>	D-	S-		1.820 €
177↔179,5	88	81	83	84	87	<b>GALA12P180</b>	D-	S-		1.960 €
H 150↔210 L 114,5↔180				SPECIAL		<b>GALA12PSP</b>	-	-		2.164 €

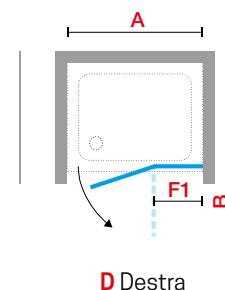
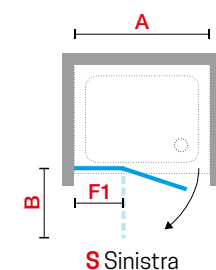
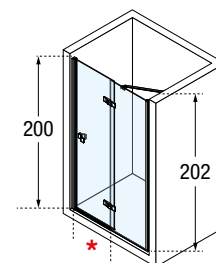

**A**  
Misura effettiva d'ingombro

**G**  
Misura centro lastra

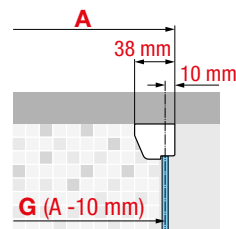

# GALA 1B



200 cm



8 mm



2,5 cm



## PORTA DOCCIA APERTURA 1 ANTA BATTENTE E 1 FISSO IN LINEA, IN NICCHIA

Design Marco Pellici



### FINITURE VETRI



Trasparente  
cod 1

### FINITURE PROFILI



Cromo  
cod K

Misure						Codice	Destra D-	Sinistra S-	Scelta vetro 1	Scelta profilo K
Misura effettiva d'ingombro	Fisso frontale	Entrata (cm)		Ingombro anta esterno						
		Min.	Max.	Min.	Max.	Trasparente	Cromo			
<b>A</b>	<b>F1</b>	*	*	<b>B</b>	<b>B</b>					
77↔79,5	18	51	53	54	57	<b>GALA11B80</b>	D-	S-	1.233 €	
87↔89,5	18	61	63	64	67	<b>GALA11B90</b>	D-	S-	1.332 €	
97↔99,5	18	71	73	74	77	<b>GALA11B100</b>	D-	S-	1.429 €	
107↔109,5	18	81	83	84	87	<b>GALA11B110</b>	D-	S-	1.528 €	
117↔119,5	28	81	83	84	87	<b>GALA11B120</b>	D-	S-	1.624 €	
H 150↔210 L 77↔120				SPECIAL		<b>GALA11BSP</b>			1.732 €	

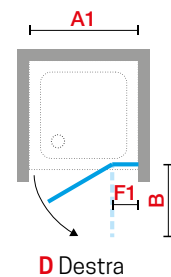
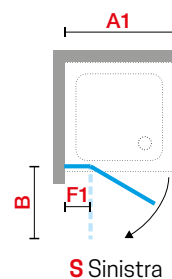
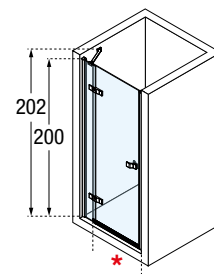

**A**  
Misura effettiva  
d'ingombro

**G**  
Misura centro  
lastra

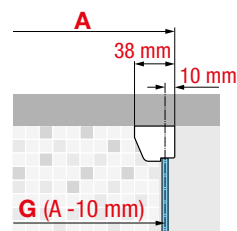

Costruzione  
del codice

Codice

+

Sinistra/Destra

+

Vetro

+

Profilo

= Codice  
prodotto finale

# GALA G+F



## BOX DOCCIA AD ANGOLO APERTURA 1 ANTA BATTENTE E 1 FISSA IN LINEA CON 1 PARETE FISSA LATERALE

Design Marco Pellici

Misure							Codice	Destra	Sinistra	Scelta vetro	Scelta profilo	
Misura effettiva d'ingombro	Misura centro lastra	Fisso frontale	Entrata		Ingombro anta esterno			D-	S-	1	K	
			Min.	Max.	Min.	Max.						
A	G	F1	*	*	B	B				Trasparente	Cromo	
<b>PORTA</b>												
76↔78,5	75↔77,5	18	51	54	54	57	<b>GALA1G80</b>	D-	S-		1.009 €	
86↔88,5	85↔87,5	18	61	64	64	67	<b>GALA1G90</b>	D-	S-		1.094 €	
96↔98,5	95↔97,5	18	71	74	74	77	<b>GALA1G100</b>	D-	S-		1.178 €	
106↔108,5	105↔107,5	18	81	84	84	87	<b>GALA1G110</b>	D-	S-		1.260 €	
116↔118,5	115↔117,5	28	81	84	84	87	<b>GALA1G120</b>	D-	S-		1.345 €	
H 150†210 L 76↔120							SPECIAL	<b>GALA1GSP</b>	-	-		2.097 €
<b>PARETE FISSA</b>												
<b>F</b>	<b>G</b>											
66↔68,5	65↔67,5	-	-	-	-	-	<b>GALA1F70-</b>				603 €	
71↔73,5	70↔72,5	-	-	-	-	-	<b>GALA1F75-</b>				633 €	
76↔78,5	75↔77,5	-	-	-	-	-	<b>GALA1F80-</b>				660 €	
86↔88,5	85↔87,5	-	-	-	-	-	<b>GALA1F90-</b>	-	-		688 €	
96↔98,5	95↔97,5	-	-	-	-	-	<b>GALA1F100-</b>				717 €	
106↔108,5	105↔107,5	-	-	-	-	-	<b>GALA1F110-</b>				744 €	
116↔118,5	115↔117,5	-	-	-	-	-	<b>GALA1F120-</b>				772 €	
H 150†210 L 26↔121							SPECIAL	<b>GALA1FSP</b>				839 €

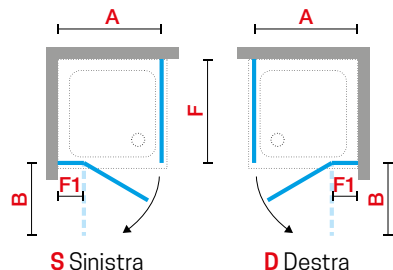
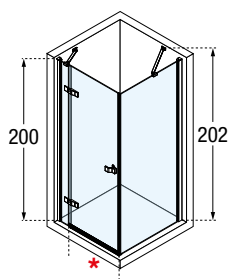

**A**  
Misura effettiva d'ingombro

**G**  
Misura centro lastra

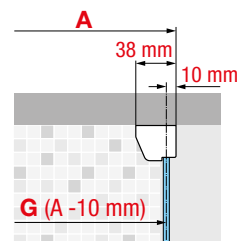



**FINITURE VETRI**

Trasparente  
cod 1

**FINITURE PROFILI**

Cromo  
cod K

## BARRE DI SOSTEGNO

### BARRA DI SOSTEGNO STANDARD (IN DOTAZIONE)



### OPTIONAL

	<b>1</b>	<b>BARRA DI SOSTEGNO ORIENTABILE</b> <ul style="list-style-type: none"> <li>1 barra orientabile (accorciabile)</li> <li>1 attacco a muro</li> <li>1 morsetto di fissaggio al vetro</li> </ul>																		
			<table border="1"> <thead> <tr> <th>Finitura</th> <th>Misure</th> <th>Codice</th> <th>Prezzo</th> </tr> </thead> <tbody> <tr> <td></td> <td>100</td> <td><b>R80KUOR100-K</b></td> <td>127 €</td> </tr> <tr> <td>Cromo</td> <td>150</td> <td><b>R80KUOR150-K</b></td> <td>132 €</td> </tr> <tr> <td></td> <td>180</td> <td><b>R80KUOR180-K</b></td> <td>135 €</td> </tr> </tbody> </table>	Finitura	Misure	Codice	Prezzo		100	<b>R80KUOR100-K</b>	127 €	Cromo	150	<b>R80KUOR150-K</b>	132 €		180	<b>R80KUOR180-K</b>	135 €	
	Finitura	Misure	Codice	Prezzo																
	100	<b>R80KUOR100-K</b>	127 €																	
Cromo	150	<b>R80KUOR150-K</b>	132 €																	
	180	<b>R80KUOR180-K</b>	135 €																	
	<b>2</b>	<b>KIT 2 BARRE A "T"</b> <ul style="list-style-type: none"> <li>2 barre da 150 cm (accorciabili)</li> <li>1 attacco a muro</li> <li>2 morsetti di fissaggio al vetro</li> <li>1 raccordo barre</li> </ul>																		
			<table border="1"> <thead> <tr> <th>Finitura</th> <th>Codice</th> <th>Prezzo</th> </tr> </thead> <tbody> <tr> <td>Cromo</td> <td><b>R80KUORT150-K</b></td> <td>183 €</td> </tr> </tbody> </table>	Finitura	Codice	Prezzo	Cromo	<b>R80KUORT150-K</b>	183 €											
Finitura	Codice	Prezzo																		
Cromo	<b>R80KUORT150-K</b>	183 €																		
	<b>3</b>	<b>SISTEMA DI FISSAGGIO EVO (angolo)</b> <ul style="list-style-type: none"> <li>1 barra frontale da 180 cm</li> <li>1 barra laterale da 120 cm</li> <li>2 morsetti di fissaggio</li> <li>1 angolare di unione</li> </ul>																		
			<table border="1"> <thead> <tr> <th>Finitura</th> <th>Codice</th> <th>Prezzo</th> </tr> </thead> <tbody> <tr> <td>Cromo</td> <td><b>KUADHSF-K</b></td> <td>267 €</td> </tr> </tbody> </table>	Finitura	Codice	Prezzo	Cromo	<b>KUADHSF-K</b>	267 €											
Finitura	Codice	Prezzo																		
Cromo	<b>KUADHSF-K</b>	267 €																		
	<b>4</b>	<b>SISTEMA DI FISSAGGIO EVO (in nicchia)</b> <ul style="list-style-type: none"> <li>1 barra frontale da 180 cm</li> <li>1 morsetto di fissaggio</li> </ul>																		
			<table border="1"> <thead> <tr> <th>Finitura</th> <th>Codice</th> <th>Prezzo</th> </tr> </thead> <tbody> <tr> <td>Cromo</td> <td><b>KUADHSFN-K</b></td> <td>204 €</td> </tr> </tbody> </table>	Finitura	Codice	Prezzo	Cromo	<b>KUADHSFN-K</b>	204 €											
Finitura	Codice	Prezzo																		
Cromo	<b>KUADHSFN-K</b>	204 €																		

### ESEMPI COMBINAZIONI BARRE DI SOSTEGNO

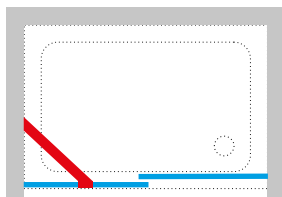

Per questa combinazione ordinare:

- 1** Barra di sostegno orientabile

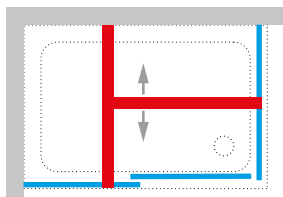

Per questa combinazione ordinare:

- 2** Kit 2 barre a "T"

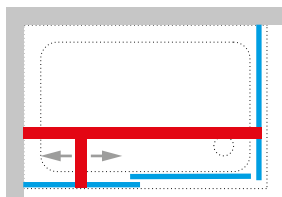

Per questa combinazione ordinare:

- 2** Kit 2 barre a "T"

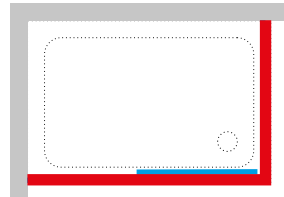

Per questa combinazione ordinare:

- 3** Sistema di fissaggio EVO (ANGOLO)

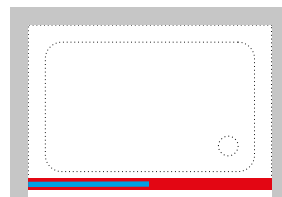

Per questa combinazione ordinare:

- 4** Sistema di fissaggio EVO (IN NICCHIA)

## DATI TECNICI

### FINITURE PROFILI



Cromo  
cod. K



### VETRO TEMPRATO 8 mm (European Standards EN 14428)



Trasparente  
cod. 1



### MANIGLIA



Maniglia in metallo  
cromato  
interasse 30 mm

### MISURE DI INGOMBRO PROFILI DI FISSAGGIO

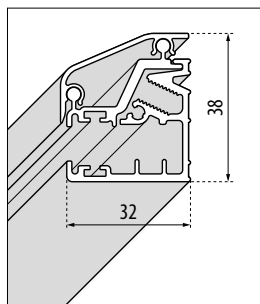

**A MURO**  
per GALA G / 1B / 2P

Finitura	Codice
Cromo	<b>KP01GA1MO-K</b>

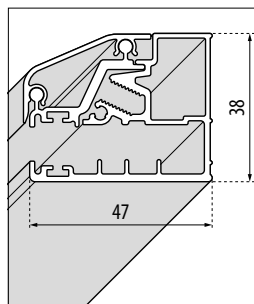

**A MURO**  
per parete fissa

Finitura	Codice
Cromo	<b>KP01GA1FI-K</b>

### COME RILEVARE LE MISURE

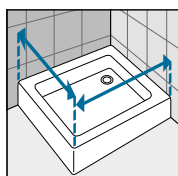

Rilevare le misure da muro a bordo esterno del piatto doccia. Le misure devono essere rilevate sulla parete finita, a rivestimenti posati, secondo gli schemi riportati.

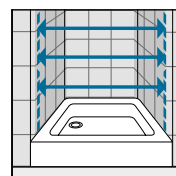

Rilevare le misure da muro a muro, in basso, in alto, al centro e utilizzare quella di valore inferiore. Le misure devono essere rilevate sulla parete finita, a rivestimenti posati, secondo gli schemi riportati.

# LOUVRE

UN TOCCO DI GRANDE ELEGANZA.



◀ Cerniere in metallo cromato con sollevamento dell'anta



◀ Barra di sostegno a muro



◀ Profilo di tenuta a pavimento per un ingresso senza barriere

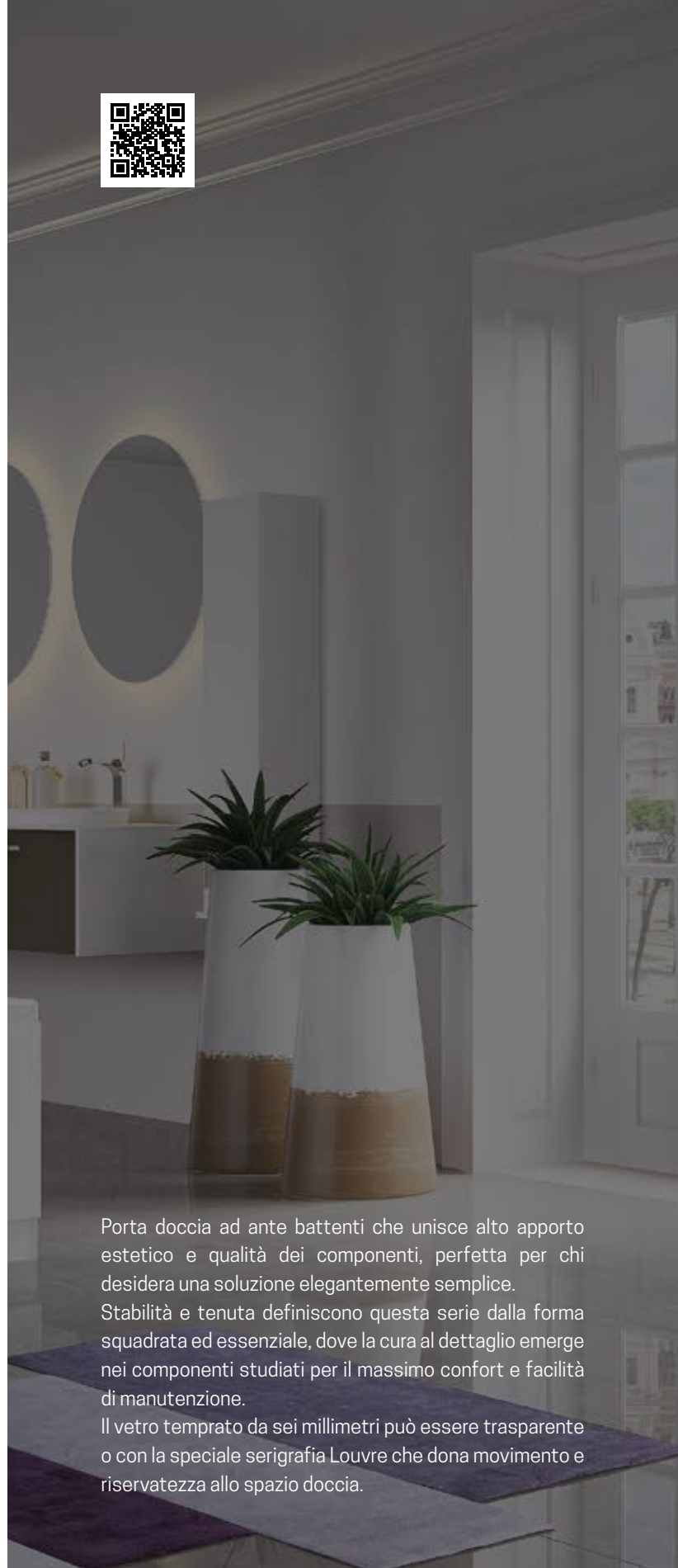

Porta doccia ad ante battenti che unisce alto apporto estetico e qualità dei componenti, perfetta per chi desidera una soluzione elegantemente semplice. Stabilità e tenuta definiscono questa serie dalla forma squadrata ed essenziale, dove la cura al dettaglio emerge nei componenti studiati per il massimo confort e facilità di manutenzione. Il vetro temprato da sei millimetri può essere trasparente o con la speciale serigrafia Louvre che dona movimento e riservatezza allo spazio doccia.

## TRATTAMENTI





# LOUVRE

# LOUVRE G+F



195 cm



6 mm



3 cm



Porta



Fisso



## BOX DOCCIA AD ANGOLO APERTURA 1 ANTA BATTENTE E 1 FISSO IN LINEA CON 1 PARETE FISSA LATERALE

Misure					Codice	Destra D-	Sinistra S-	Scelta vetro		Scelta profilo	
Misura effettiva d'ingombro <b>A</b>	Misura centro lastra <b>G</b>	Fisso frontale <b>F1</b>	Entrata (cm) <b>*</b>	Ingombro anta esterno <b>B</b>				<b>1</b>	<b>58</b>	<b>B</b>	<b>K</b>
								Trasparente	Serigrafia Louvre	Silver	Cromo
<b>PORTA</b>											
67,5↔70,5	66↔69	15	50	51	<b>LOUVNGF70L</b>	D-	S-			633 €	695 €
72,5↔75,5	71↔74	20	50	51	<b>LOUVNGF75L</b>	D-	S-			644 €	709 €
77,5↔80,5	76↔79	25	50	51	<b>LOUVNGF80L</b>	D-	S-			663 €	727 €
82,5↔85,5	81↔84	15	65	66	<b>LOUVNGF85L</b>	D-	S-			684 €	752 €
87,5↔90,5	86↔89	20	65	66	<b>LOUVNGF90L</b>	D-	S-			707 €	777 €
92,5↔95,5	91↔94	25	65	66	<b>LOUVNGF95L</b>	D-	S-			728 €	800 €
97,5↔100,5	96↔99	30	65	66	<b>LOUVNGF100L</b>	D-	S-	+ 38 €		752 €	827 €
107,5↔110,5	106↔107	40	65	66	<b>LOUVNGF110L</b>	D-	S-			793 €	872 €
117,5↔120,5	116↔119	50	65	66	<b>LOUVNGF120L</b>	D-	S-			852 €	935 €
137,5↔140,5	136↔139	50	85	86	<b>LOUVNGF140L</b>	D-	S-			905 €	994 €
147,5↔150,5	146↔149	60	85	86	<b>LOUVNGF150L</b>	D-	S-			958 €	1.052 €
157,5↔160,5	156↔159	70	85	86	<b>LOUVNGF160L</b>	D-	S-			1.010 €	1.109 €
167,5↔170,5	166↔169	80	85	86	<b>LOUVNGF170L</b>	D-	S-			1.064 €	1.170 €

<b>PARETE FISSA REVERSIBILE</b>											
<b>F</b>											
66,5↔69,5	65↔68	-	-	-	<b>LOUVNF70-</b>					528 €	579 €
71,5↔74,5	70↔73	-	-	-	<b>LOUVNF75-</b>					558 €	614 €
76,5↔79,5	75↔78	-	-	-	<b>LOUVNF80-</b>					588 €	647 €
81,5↔84,5	80↔83	-	-	-	<b>LOUVNF85-</b>					618 €	679 €
86,5↔89,5	85↔88	-	-	-	<b>LOUVNF90-</b>	-	-	+ 38 €		648 €	712 €
91,5↔94,5	90↔93	-	-	-	<b>LOUVNF95-</b>					679 €	745 €
96,5↔99,5	95↔98	-	-	-	<b>LOUVNF100-</b>					709 €	778 €
106,5↔109,5	105↔108	-	-	-	<b>LOUVNF110-</b>					723 €	795 €
116,5↔119,5	115↔118	-	-	-	<b>LOUVNF120-</b>					738 €	808 €

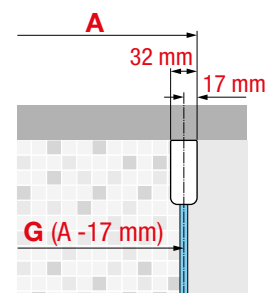
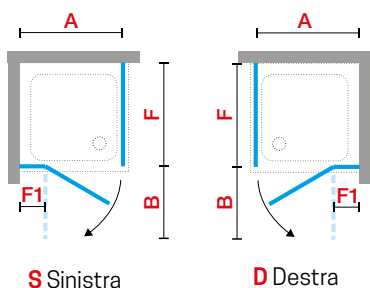
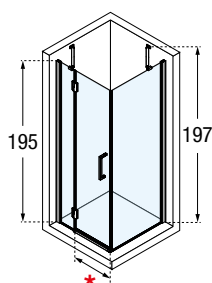

**A** Misura effettiva d'ingombro  
**G** Misura centro lastra





#### FINITURE VETRI



Trasparente  
cod 1

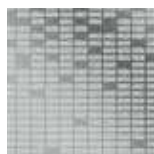

Ser. Louvre  
cod 58

#### FINITURE PROFILI

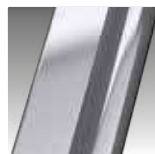

Silver  
cod B



Cromo  
cod K

# LOUVRE G



## PORTA DOCCIA APERTURA 1 ANTA BATTENTE E 1 FISSO IN LINEA, IN NICCHIA

Misure				Codice	Destra	Sinistra	Scelta vetro		Scelta profilo	
Misura effettiva d'ingombro	Fisso frontale	Entrata (cm)	Ingombro anta esterno		D-	S-	1	58	B	K
A	F1	*	B				Trasparente	Serigrafia Louvre	Silver	Cromo
68↔71	15	50	51	<b>LOUVNG70L</b>	D-	S-	+ 38 €		633 €	695 €
73↔76	20	50	51	<b>LOUVNG75L</b>	D-	S-			644 €	709 €
78↔81	25	50	51	<b>LOUVNG80L</b>	D-	S-			663 €	727 €
83↔86	15	65	66	<b>LOUVNG85L</b>	D-	S-			684 €	752 €
88↔91	20	65	66	<b>LOUVNG90L</b>	D-	S-			707 €	777 €
93↔96	25	65	66	<b>LOUVNG95L</b>	D-	S-			728 €	800 €
98↔101	30	65	66	<b>LOUVNG100L</b>	D-	S-			752 €	827 €
108↔111	40	65	66	<b>LOUVNG110L</b>	D-	S-			793 €	872 €
118↔121	50	65	66	<b>LOUVNG120L</b>	D-	S-			852 €	935 €
138↔141	50	85	86	<b>LOUVNG140L</b>	D-	S-			905 €	994 €
148↔151	60	85	86	<b>LOUVNG150L</b>	D-	S-			958 €	1.052 €
158↔161	70	85	86	<b>LOUVNG160L</b>	D-	S-			1.010 €	1.109 €
168↔171	80	85	86	<b>LOUVNG170L</b>	D-	S-			1.064 €	1.170 €

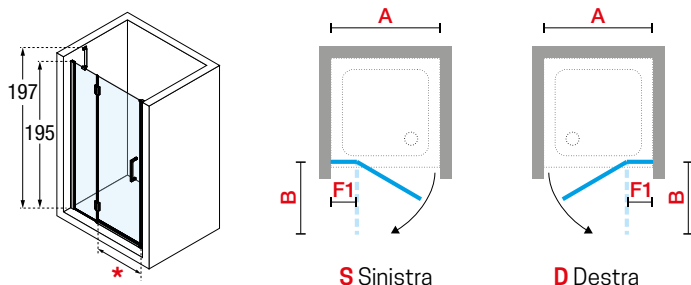





**FINITURE VETRI**



Trasparente  
cod 1



Ser. Louvre  
cod 58

**FINITURE PROFILI**

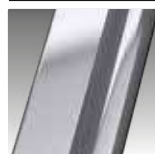

Silver  
cod B



Cromo  
cod K

# LOUVRE A



BOX DOCCIA AD ANGOLO APERTURA 2 ANTE A BATTENTE E 2 FISSE IN LINEA



## FINITURE VETRI

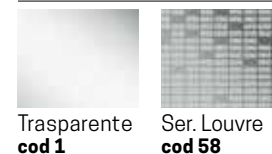

## FINITURE PROFILI

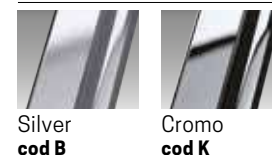

Misure					Codice	Destra	Sinistra	Scelta vetro		Scelta profilo		
Misura effettiva d'ingombro	Misura centro lastra	Fisso frontale	Entrata (cm)	Ingombro anta esterno				1	58	B	K	
<b>A</b>	<b>G</b>	<b>F1</b>	<b>*</b>	<b>B</b>				Trasparente	Serigrafia Louvre	Silver	Cromo	
66,5↔69,5	65↔68	15	71	51	<b>LOUVNA70L</b>	D-	S-			633 €	695 €	
71,5↔74,5	70↔73	20	71	51	<b>LOUVNA75L</b>	D-	S-			648 €	712 €	
76,5↔79,5	75↔78	25	71	51	<b>LOUVNA80L</b>	D-	S-			663 €	727 €	
81,5↔84,5	80↔83	30	71	51	<b>LOUVNA85L</b>	D-	S-			679 €	745 €	
86,5↔89,5	85↔88	35	71	51	<b>LOUVNA90L</b>	D-	S-			+ 38 €	693 €	760 €
91,5↔94,5	90↔93	40	71	51	<b>LOUVNA95L</b>	D-	S-			709 €	778 €	
96,5↔99,5	95↔98	45	71	51	<b>LOUVNA100L</b>	D-	S-			723 €	795 €	
106,5↔109,5	105↔108	55	71	51	<b>LOUVNA110L</b>	D-	S-			753 €	827 €	
116,5↔119,5	115↔118	50	92	65	<b>LOUVNA120L</b>	D-	S-			783 €	858 €	

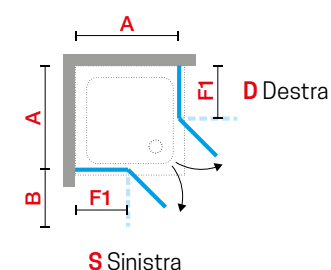
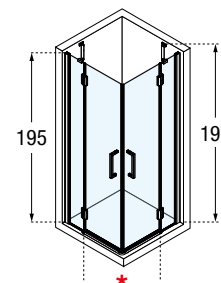

PER COMPORRE UN ANGOLO ORDINARE DUE LATI (LATO DESTRO + LATO SINISTRO)

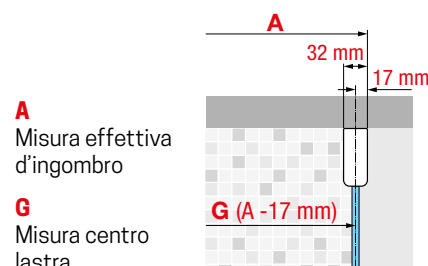

## DATI TECNICI

### FINITURE PROFILI



Silver  
cod. B



Cromo  
cod. K



### VETRO TEMPRATO 6 mm (European Standards EN 14428)



Trasparente  
cod. 1



### SERIGRAFIA

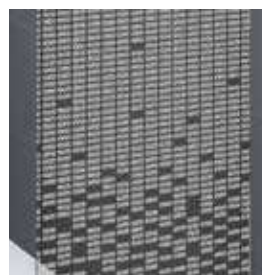

Louvre  
cod. 58

### BARRA DI SOSTEGNO STANDARD (IN DOTAZIONE)



Per altre barre di sostegno vedi pag. 070

### MANIGLIA



Maniglia in metallo  
cromato  
interasse 256 mm

### MISURE DI INGOMBRO PROFILI DI FISSAGGIO

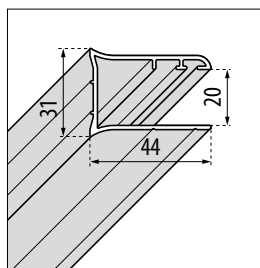

**A MURO**  
per tutti i modelli

Finitura	Codice
Silver	<b>P01BI2MOST-B</b>
Cromo	<b>P01BI2MOST-K</b>

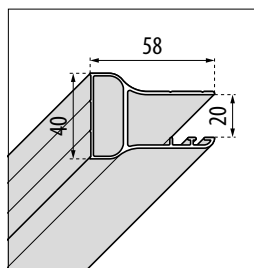

**COMPENSATIVI**  
per tutti i modelli

Finitura	Codice
Silver	<b>P05BI2MOST-B</b>
Cromo	<b>P05BI2MOST-K</b>

### COME RILEVARE LE MISURE

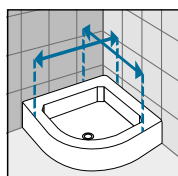
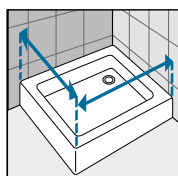

Rilevare le misure da muro a bordo esterno del piatto doccia. Le misure devono essere rilevate sulla parete finita, a rivestimenti posati, secondo gli schemi riportati.

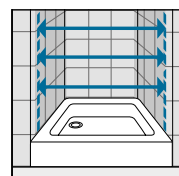

Rilevare le misure da muro a muro, in basso, in alto, al centro e utilizzare quella di valore inferiore. Le misure devono essere rilevate sulla parete finita, a rivestimenti posati, secondo gli schemi riportati.

# BRERA

IL TUO SPAZIO PREFERITO  
È DESIGN E SOSTANZA IN UN BOX.



◀ Cerniere in metallo cromato



◀ Barra di sostegno



◀ Maniglia e cerniere  
in metallo cromato  
design Marco Pellici



Una serie box doccia Novellini ad ante battenti versatile e dal design contemporaneo. Il suo gusto semplice ma raffinato si adatta con facilità a tutti gli ambienti bagno. Sicurezza e qualità si rispecchiano nel trattamento antigocce Crystal Clear, che rallenta la formazione del calcare e dei batteri e facilita la pulizia, e nell'impiego di alluminio NewChrome - ecologico, resistente, sicuro.

## TRATTAMENTI





# BRERA



## BOX DOCCIA AD ANGOLO APERTURA 1 ANTA BATTENTE CON 1 PARETE FISSA LATERALE

Misure					Codice	Destra	Sinistra	Scelta vetro			Scelta profilo	
Misura effettiva d'ingombro	Misura centro lastra	Fisso frontale	Entrata (cm)	Ingombro anta esterno				1	54	79	B	K
<b>A</b>	<b>G</b>	<b>F1</b>	<b>*</b>	<b>B</b>				Trasparente	Fumè	Serigrafia Jeans	Silver	Cromo
<b>PORTA</b>												
67↔69	66↔68	18	46	49	<b>BRERAGF70L</b>	D-	S-				684 €	753 €
72↔74	71↔73	23	46	49	<b>BRERAGF75L</b>	D-	S-				714 €	785 €
77↔79	76↔78	28	46	49	<b>BRERAGF80L</b>	D-	S-				743 €	818 €
82↔84	81↔83	33	46	49	<b>BRERAGF85L</b>	D-	S-				770 €	848 €
87↔89	86↔88	23	61	64	<b>BRERAGF90L</b>	D-	S-				803 €	884 €
92↔94	91↔93	28	61	64	<b>BRERAGF95L</b>	D-	S-				834 €	918 €
97↔99	96↔98	33	61	64	<b>BRERAGF100L</b>	D-	S-				867 €	954 €
107↔109	106↔108	43	61	64	<b>BRERAGF110L</b>	D-	S-	+100 €		+38 €	899 €	990 €
117↔119	116↔118	53	61	64	<b>BRERAGF120L</b>	D-	S-				932 €	1.024 €
127↔129	126↔128	53	71	74	<b>BRERAGF130L</b>	D-	S-				948 €	1.043 €
137↔139	136↔138	63	71	74	<b>BRERAGF140L</b>	D-	S-				963 €	1.060 €
147↔149	146↔148	73	71	74	<b>BRERAGF150L</b>	D-	S-				1.009 €	1.109 €
157↔159	156↔158	83	71	74	<b>BRERAGF160L</b>	D-	S-				1.068 €	1.175 €
167↔169	166↔168	93	71	74	<b>BRERAGF170L</b>	D-	S-				1.129 €	1.242 €
H 170↔220 L 67↔169				SPECIAL	<b>BRERAGFSP</b>	-	-	-	-		1.274 €	1.402 €

<b>PARETE FISSA REVERSIBILE</b>												
<b>F</b>	<b>G</b>											
67↔69	66↔68	-	-	-	<b>BRERAF70-</b>						528 €	579 €
72↔74	71↔73	-	-	-	<b>BRERAF75-</b>						558 €	614 €
77↔79	76↔78	-	-	-	<b>BRERAF80-</b>						588 €	647 €
82↔84	81↔83	-	-	-	<b>BRERAF85-</b>						618 €	679 €
87↔89	86↔88	-	-	-	<b>BRERAF90-</b>	-	-	+100 €		+38 €	648 €	712 €
92↔94	91↔93	-	-	-	<b>BRERAF95-</b>						679 €	745 €
97↔99	96↔98	-	-	-	<b>BRERAF100-</b>						709 €	778 €
107↔109	106↔108	-	-	-	<b>BRERAF110-</b>						723 €	795 €
117↔119	116↔118	-	-	-	<b>BRERAF120-</b>						738 €	808 €
H 170↔220 L 20↔119				SPECIAL	<b>BRERAFSP</b>			+100 €		-	778 €	854 €

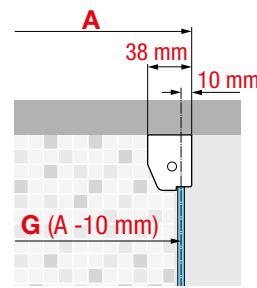
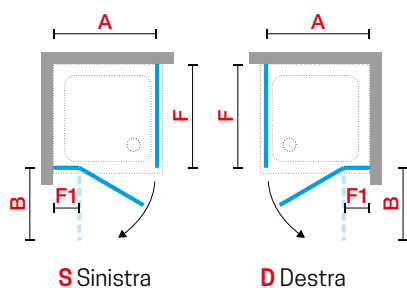
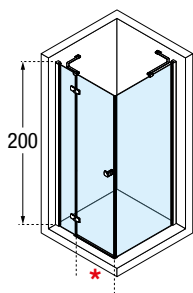

**A**  
Misura effettiva d'ingombro

**G**  
Misura centro lastra





#### FINITURE VETRI



Trasparente  
cod 1

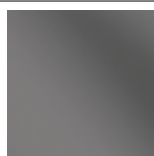

Fumé  
cod 54



Jeans  
cod 79

#### FINITURE PROFILI

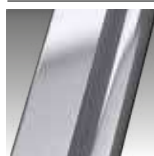

Silver  
cod B



Cromo  
cod K

## PORTA DOCCIA APERTURA 1 ANTA BATTENTE E 1 FISSO IN LINEA, IN NICCHIA

Misure				Codice	Destra	Sinistra	Scelta vetro			Scelta profilo	
Misura effettiva d'ingombro	Fisso frontale	Entrata (cm)	Ingombro anta esterno		D-	S-	1	54	79	B	K
<b>A</b>	<b>F1</b>	*	<b>B</b>				Trasparente	Fumè	Serigrafia Jeans	Silver	Cromo
69↔71	18	46	49	<b>BRERAG70L</b>	D-	S-				684 €	753 €
74↔76	23	46	49	<b>BRERAG75L</b>	D-	S-				714 €	785 €
79↔81	28	46	49	<b>BRERAG80L</b>	D-	S-				743 €	818 €
84↔86	33	46	49	<b>BRERAG85L</b>	D-	S-				770 €	848 €
89↔91	23	61	64	<b>BRERAG90L</b>	D-	S-				803 €	884 €
94↔96	28	61	64	<b>BRERAG95L</b>	D-	S-				834 €	918 €
99↔101	33	61	64	<b>BRERAG100L</b>	D-	S-				867 €	954 €
109↔111	43	61	64	<b>BRERAG110L</b>	D-	S-		+ 100 €	+ 38 €	899 €	990 €
119↔121	53	61	64	<b>BRERAG120L</b>	D-	S-				932 €	1.024 €
129↔131	53	71	74	<b>BRERAG130L</b>	D-	S-				948 €	1.043 €
139↔141	63	71	74	<b>BRERAG140L</b>	D-	S-				963 €	1.060 €
149↔151	73	71	74	<b>BRERAG150L</b>	D-	S-				1.009 €	1.109 €
159↔161	83	71	74	<b>BRERAG160L</b>	D-	S-				1.068 €	1.175 €
169↔171	93	71	74	<b>BRERAG170L</b>	D-	S-				1.129 €	1.242 €
H 170↔220 L 68↔170			SPECIAL	<b>BRERAGSP</b>	-	-		-	-	1.274 €	1.402 €

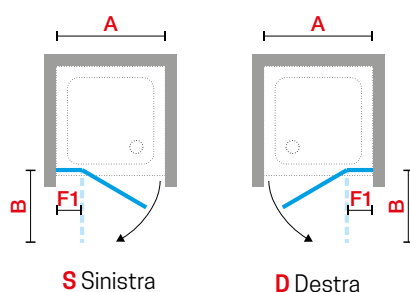
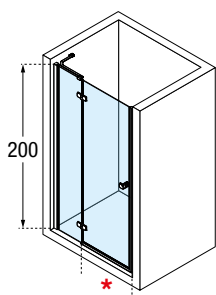





#### FINITURE VETRI



Trasparente  
cod 1



Fumé  
cod 54



Jeans  
cod 79

#### FINITURE PROFILI

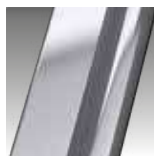

Silver  
cod B



Cromo  
cod K

# BRERA A



**BOX DOCCIA AD ANGOLO APERTURA 2 ANTE A BATTENTE E 2 FISSE IN LINEA**



## FINITURE VETRI



## FINITURE PROFILI

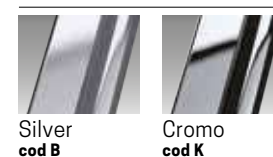

Misure					Codice	Destra	Sinistra	Scelta vetro			Scelta profilo	
Misura effettiva d'ingombro	Misura centro lastra	Fisso frontale	Entrata (cm)	Ingombro anta esterno				1	54	79	B	K
<b>A</b>	<b>G</b>	<b>F1</b>	<b>*</b>	<b>B</b>				Trasparente	Fumé	Serigrafia Jeans	Silver	Cromo
67↔69	66↔68	18	69	49	<b>BRERAA70L</b>	D-	S-				654 €	719 €
72↔74	71↔73	23	69	49	<b>BRERAA75L</b>	D-	S-				668 €	737 €
77↔79	76↔78	28	69	49	<b>BRERAA80L</b>	D-	S-				683 €	752 €
82↔84	81↔83	33	69	49	<b>BRERAA85L</b>	D-	S-				700 €	770 €
87↔89	86↔88	23	90	64	<b>BRERAA90L</b>	D-	S-		+100 €	+38 €	714 €	785 €
92↔94	91↔93	28	90	64	<b>BRERAA95L</b>	D-	S-				729 €	803 €
97↔99	96↔98	33	90	64	<b>BRERAA100L</b>	D-	S-				747 €	823 €
107↔109	106↔108	43	90	64	<b>BRERAA110L</b>	D-	S-				777 €	854 €
117↔119	116↔118	53	90	64	<b>BRERAA120L</b>	D-	S-				807 €	888 €
H 170↔220												
L 66↔118			SPECIAL		<b>BRERAA1SP</b>				-	-	935 €	1.030 €

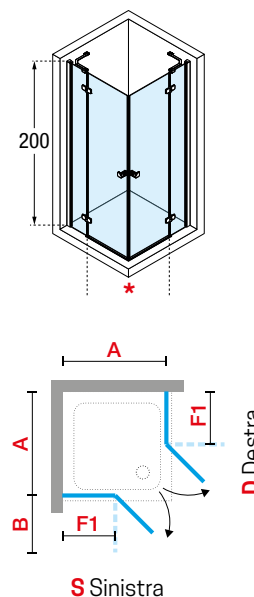

**PER COMPORRE UN ANGOLO ORDINARE 2 LATI (1 LATO DESTRO + 1 LATO SINISTRO)**

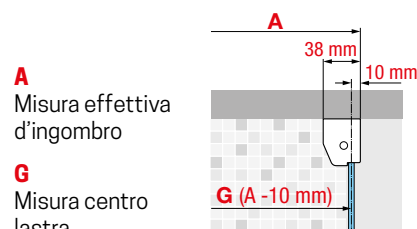

# BRERA R



200 cm



6 mm



2 cm



BOX DOCCIA AD ANGOLO SEMICIRCOLARE, APERTURA 1 ANTA BATTENTE E 2 FISSE



## FINITURE VETRI



Trasparente  
cod 1



Jeans  
cod 79

## FINITURE PROFILI



Silver  
cod B



Cromo  
cod K

Misure						Codice	Scelta vetro		Scelta profilo	
Misura effettiva d'ingombro	Misura centro lastra	Fisso frontale	Raggio	Entrata (cm)	Ingombro anta esterno		1	79	B	K
<b>A</b>	<b>G</b>	<b>F1</b>	<b>R</b>	*	<b>B</b>		Trasparente	Serigrafia Jeans	Silver	Cromo
77↔79	76↔78	18	55	82	43	<b>BRERAR80-</b>			1.857 €	2.043 €
87↔89	86↔88	28	55	82	43	<b>BRERAR90-</b>		+ 76 €	1.948 €	2.143 €
97↔99	96↔98	38	55	82	43	<b>BRERAR100-</b>			2.042 €	2.245 €

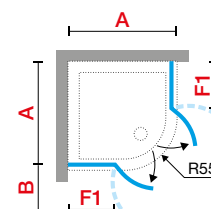
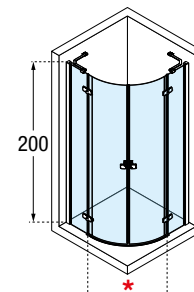

**A**  
Misura effettiva d'ingombro

**G**  
Misura centro lastra

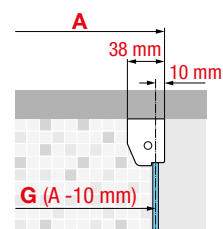

Costruzione del codice

Codice

+

Vetro

+

Profilo

=

Codice prodotto finale

# BRERA F SPECIAL 1



6 mm



2 cm



## PARETE FISSA SPECIALE, SPECIALE IN LARGHEZZA

Compatibile con porta BRERA G+F



### FINITURE VETRI



Trasparente  
cod 1



Fumé  
cod 54

### FINITURE PROFILI



Silver  
cod B



Cromo  
cod K

Misure	Codice	Scelta vetro		Scelta profilo	
Misura effettiva d'ingombro		<b>1</b>	<b>54</b>	<b>B</b>	<b>K</b>
<b>A</b>		Trasparente	Fumé	Silver	Cromo
H 170±220 L 20↔119	<b>BRERAFSP</b>		+ 100 €	778 €	854 €

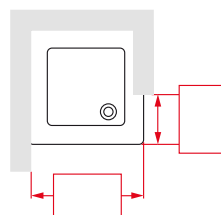
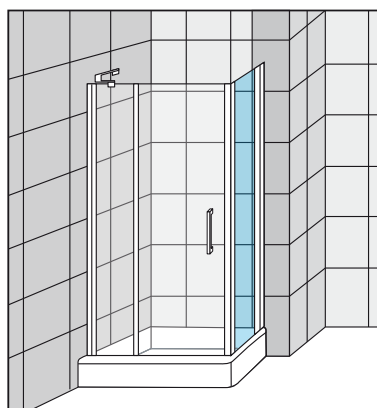
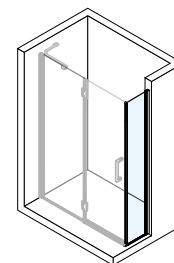

PER LA FATTIBILITÀ DELLE MISURE SPECIALI CONTATTARE IL SERVIZIO CLIENTI O CONSULTARE [HTTP://STORE.NOVELLINI.COM](http://store.novellini.com)

# BRERA F SPECIAL 2

**PARETE FISSA SPECIALE, SAGOMATA 5 LATI**

Compatibile con porta BRERA G+F



6 mm



2 cm



## FINITURE VETRI



Trasparente  
cod 1

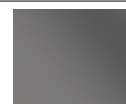

Fumé  
cod 54

## FINITURE PROFILI



Silver  
cod B



Cromo  
cod K

Misure	Codice	Scelta vetro		Scelta profilo	
Misura effettiva d'ingombro		<b>1</b>	<b>54</b>	<b>B</b>	<b>K</b>
<b>A</b>		Trasparente	Fumé	Silver	Cromo
H 170↓220 L 60↔100	<b>BRERAF2SP</b>		+ 100 €	907 €	995 €

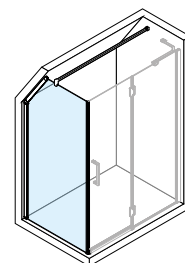

Sinistra

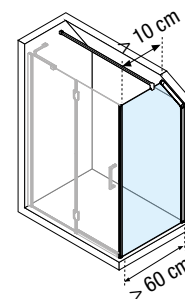

Destra

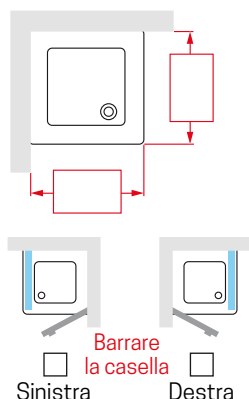
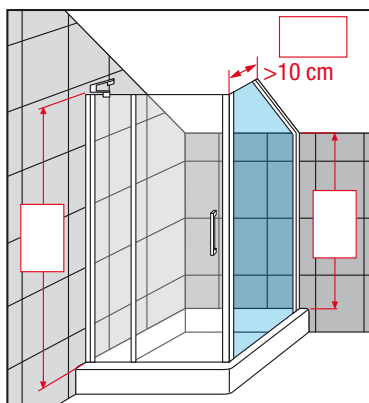

PER LA FATTIBILITÀ DELLE MISURE SPECIALI CONTATTARE IL SERVIZIO CLIENTI O CONSULTARE [HTTP://STORE.NOVELLINI.COM](http://store.novellini.com)

# BRERA F SPECIAL 3



6 mm



2 cm



## PARETE FISSA SPECIALE, SAGOMATA 6 LATI

Compatibile con porta BRERA G+F



### FINITURE VETRI



Trasparente  
cod 1



Fumé  
cod 54

### FINITURE PROFILI



Silver  
cod B



Cromo  
cod K

Misure	Codice	Scelta vetro		Scelta profilo	
Misura effettiva d'ingombro		<b>1</b>	<b>54</b>	<b>B</b>	<b>K</b>
<b>A</b>		Trasparente	Fumé	Silver	Cromo
H 170↕220 L 62↔119	<b>BRERAF3SP</b>		+ 100 €	913 €	1.003 €

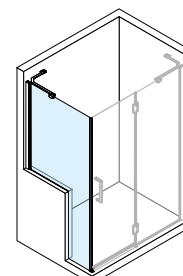

Sinistra

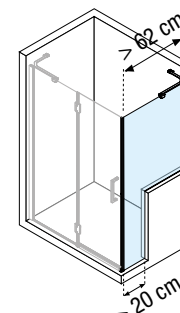

Destra

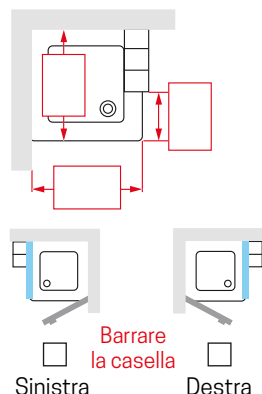
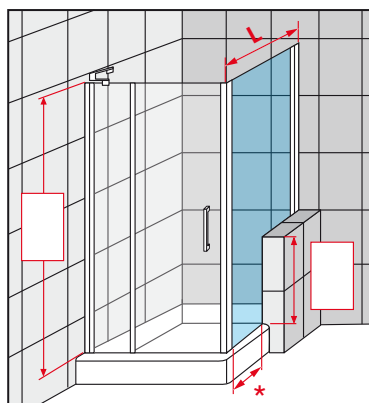

\*  $\geq L/3$ : LA QUOTA DI \* DEVE ESSERE SUPERIORE AD 1/3 DELLA LUCE SUPERIORE E COMUNQUE NON INFERIORE A 20 cm.

PER LA FATTIBILITÀ DELLE MISURE SPECIALI CONTATTARE IL SERVIZIO CLIENTI O CONSULTARE [HTTP://STORE.NOVELLINI.COM](http://store.novellini.com)

# BRERA F SPECIAL 4



6 mm



2 cm



**PARETE FISSA SPECIALE, PER INSTALLAZIONE SU MURETTO, SPECIALE IN LARGHEZZA ED ALTEZZA**

Compatibile con porta BRERA G



## FINITURE VETRI



Trasparente  
cod 1



Fumé  
cod 54

## FINITURE PROFILI



Silver  
cod B



Cromo  
cod K

Misure	Codice	Scelta vetro		Scelta profilo	
Misura effettiva d'ingombro		<b>1</b>	<b>54</b>	<b>B</b>	<b>K</b>
<b>A</b>		Trasparente	Fumé	Silver	Cromo
H 50↕220 L 20↔119	<b>BRERAF4SP</b>		+ 100 €	778 €	854 €

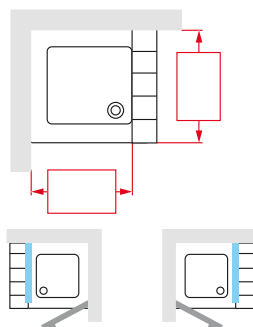
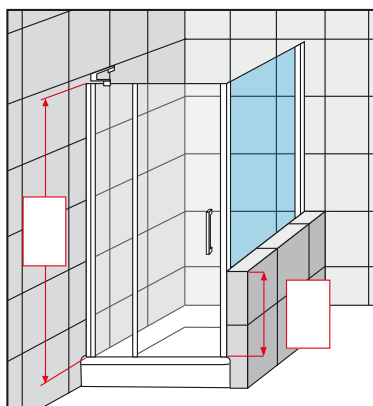
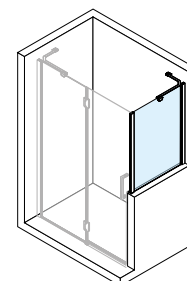

REVERSIBILE

PER LA FATTIBILITÀ DELLE MISURE SPECIALI CONTATTARE IL SERVIZIO CLIENTI O CONSULTARE [HTTP://STORE.NOVELLINI.COM](http://store.novellini.com)

## BARRE DI SOSTEGNO

### BARRA DI SOSTEGNO STANDARD (IN DOTAZIONE)



### MANIGLIA



Maniglia in metallo cromato

### OPTIONAL



1

#### BARRA DI SOSTEGNO ORIENTABILE

- 1 barra orientabile (accorciabile)
- 1 attacco a muro
- 1 morsetto di fissaggio al vetro

Finitura	Misure	Codice	Prezzo
Silver	100	<b>R80KUOR100-B</b>	117 €
Cromo	100	<b>R80KUOR100-K</b>	127 €
Silver	150	<b>R80KUOR150-B</b>	120 €
Cromo	150	<b>R80KUOR150-K</b>	132 €
Silver	180	<b>R80KUOR180-B</b>	124 €
Cromo	180	<b>R80KUOR180-K</b>	135 €



2

#### KIT 2 BARRE A "T"

- 2 barre da 150 cm (accorciabili)
- 1 attacco a muro
- 2 morsetti di fissaggio al vetro
- 1 raccordo barre

Finitura	Codice	Prezzo
Silver	<b>R80KUORT150-B</b>	172 €
Cromo	<b>R80KUORT150-K</b>	183 €

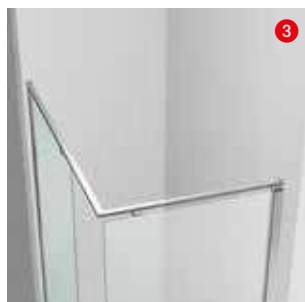

3

#### SISTEMA DI FISSAGGIO EVO (angolo)

- 1 barra frontale da 180 cm
- 1 barra laterale da 120 cm
- 2 morsetti di fissaggio
- 1 angolare di unione

Finitura	Codice	Prezzo
Silver	<b>KUADHSF-B</b>	247 €
Cromo	<b>KUADHSF-K</b>	267 €



4

#### SISTEMA DI FISSAGGIO EVO (in nicchia)

- 1 barra frontale da 180 cm
- 1 morsetto di fissaggio

Finitura	Codice	Prezzo
Silver	<b>KUADHSFN-B</b>	183 €
Cromo	<b>KUADHSFN-K</b>	204 €

### ESEMPI COMBINAZIONI BARRE DI SOSTEGNO

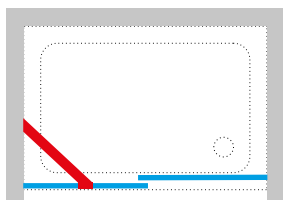

Per questa combinazione ordinare:

- 1 Barra di sostegno orientabile

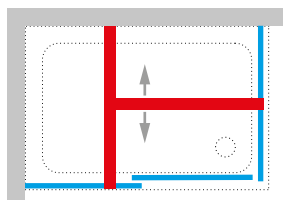

Per questa combinazione ordinare:

- 2 Kit 2 barre a "T"

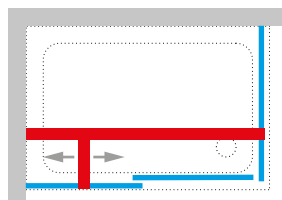

Per questa combinazione ordinare:

- 2 Kit 2 barre a "T"

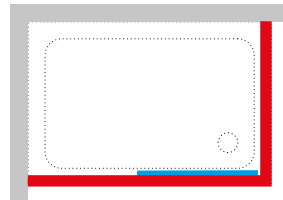

Per questa combinazione ordinare:

- 3 Sistema di fissaggio EVO (ANGOLO)

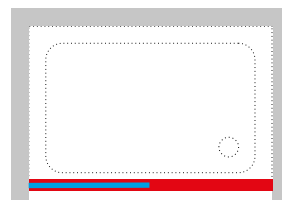

Per questa combinazione ordinare:

- 4 Sistema di fissaggio EVO (IN NICCHIA)



## DATI TECNICI

### FINITURE PROFILI



Silver  
cod. B



Cromo  
cod. K



### VETRO TEMPRATO 6 mm (European Standards EN 14428)



Trasparente  
cod. 1



Fumé  
cod. 54

### SERIGRAFIA



Jeans  
cod. 79

### MISURE DI INGOMBRO PROFILI DI FISSAGGIO

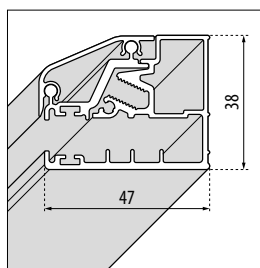

**A MURO**  
per tutti i modelli

Finitura	Codice
Cromo	<b>KP01BREMO-K</b>
Silver	<b>KP01BREMO-B</b>

### COME RILEVARE LE MISURE

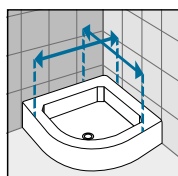
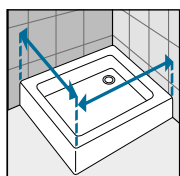

Rilevare le misure da muro a bordo esterno del piatto doccia. Le misure devono essere rilevate sulla parete finita, a rivestimenti posati, secondo gli schemi riportati.

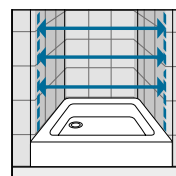

Rilevare le misure da muro a muro, in basso, in alto, al centro e utilizzare quella di valore inferiore. Le misure devono essere rilevate sulla parete finita, a rivestimenti posati, secondo gli schemi riportati.

# OPERA

LASCIATI ACCOGLIERE.  
È ARTE, DISEGNATA PER TE.



◀ Sistema Soft Closing  
in apertura e chiusura,  
scorrimento con cuscinetti  
a sfera

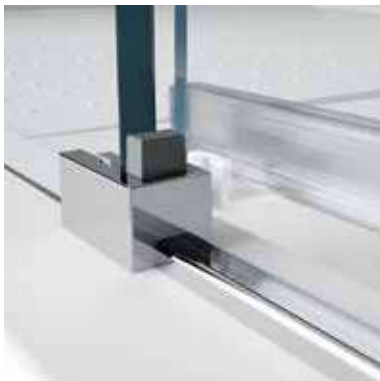

◀ Sistema di sgancio ante  
scorrevoli per una facile  
pulizia



◀ Nuovo sistema di fissaggio  
Opera PH+FH, avvitato

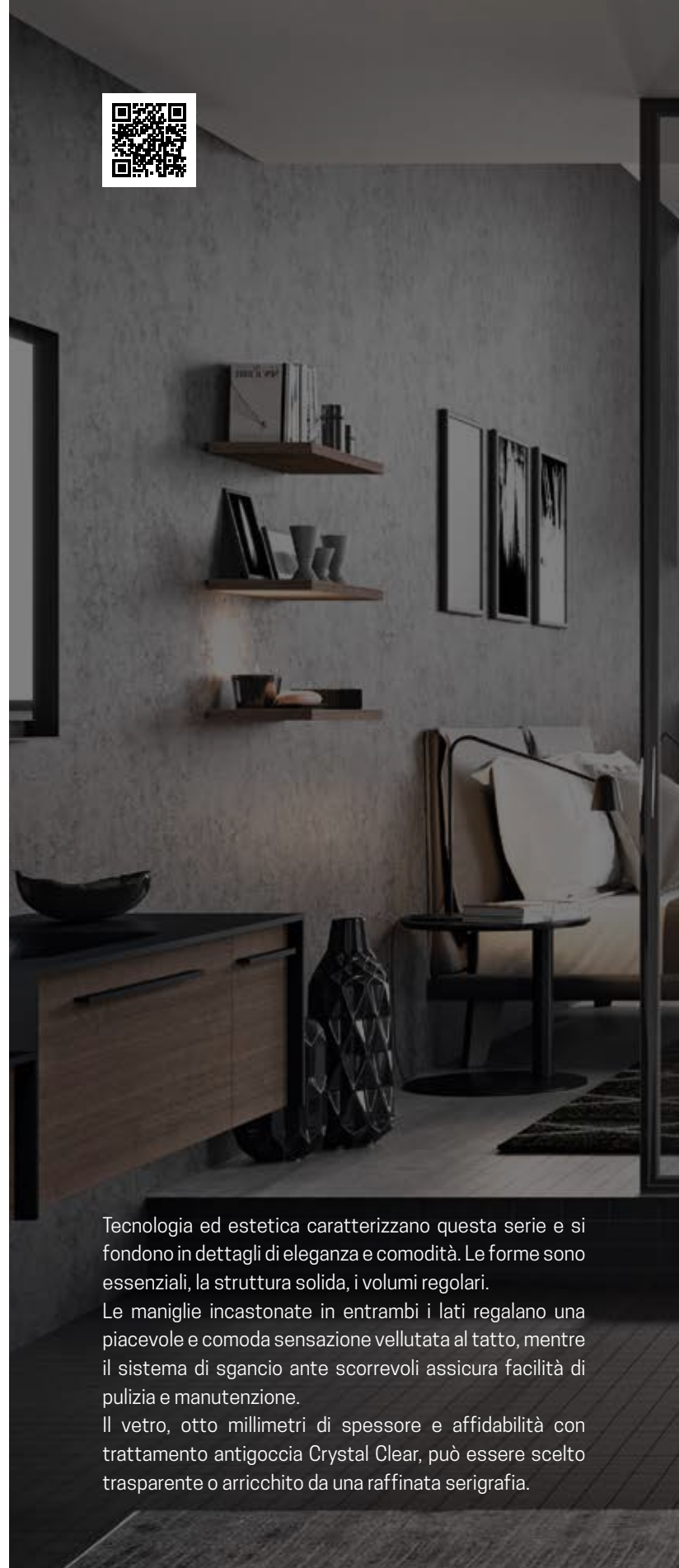

Tecnologia ed estetica caratterizzano questa serie e si fondono in dettagli di eleganza e comodità. Le forme sono essenziali, la struttura solida, i volumi regolari.

Le maniglie incastonate in entrambi i lati regalano una piacevole e comoda sensazione vellutata al tatto, mentre il sistema di sgancio ante scorrevoli assicura facilità di pulizia e manutenzione.

Il vetro, otto millimetri di spessore e affidabilità con trattamento antigoccia Crystal Clear, può essere scelto trasparente o arricchito da una raffinata serigrafia.

## TRATTAMENTI





# OPERA

# OPERA PH+FH



## BOX DOCCIA AD ANGOLO, APERTURA 1 ANTA SCORREVOLE E 1 ANTA FISSA IN LINEA CON 1 PARETE FISSA LATERALE

Misure				Codice	Destra	Sinistra	Scelta vetro		Scelta profilo			
Misura effettiva d'ingombro	Misura centro lastra	Fisso frontale	Entrata (cm)				1	51	U	B	K	H
<b>A</b>	<b>G</b>	<b>F1</b>	<b>*</b>				Trasparente	Serigrafia Ravenna	Bianco opaco	Silver	Cromo	Nero opaco
<b>PORTA</b>												
97↔99	95,9↔97,9	48,5	37	<b>OPEPH97</b>	D-	S-			922 €	968 €	1.075 €	1.075 €
99↔101	97,9↔99,9	49,5	38	<b>OPEPH99</b>	D-	S-			948 €	997 €	1.107 €	1.107 €
105↔107	103,9↔105,9	52,5	41	<b>OPEPH105</b>	D-	S-			974 €	1.023 €	1.137 €	1.137 €
107↔109	105,9↔107,9	53,5	42	<b>OPEPH107</b>	D-	S-			995 €	1.045 €	1.162 €	1.162 €
109↔111	107,9↔109,9	54,5	43	<b>OPEPH109</b>	D-	S-			1.020 €	1.073 €	1.192 €	1.192 €
115↔117	113,9↔115,9	57,5	46	<b>OPEPH115</b>	D-	S-			1.048 €	1.100 €	1.223 €	1.223 €
117↔119	115,9↔117,9	58,5	47	<b>OPEPH117</b>	D-	S-			1.067 €	1.122 €	1.244 €	1.244 €
119↔121	117,9↔119,9	59,5	48	<b>OPEPH119</b>	D-	S-			1.088 €	1.142 €	1.269 €	1.269 €
125↔127	123,9↔125,9	62,5	51	<b>OPEPH125</b>	D-	S-			1.108 €	1.164 €	1.292 €	1.292 €
127↔129	125,9↔127,9	63,5	52	<b>OPEPH127</b>	D-	S-			1.128 €	1.185 €	1.315 €	1.315 €
129↔131	127,9↔129,9	64,5	53	<b>OPEPH129</b>	D-	S-			1.148 €	1.205 €	1.339 €	1.339 €
135↔137	133,9↔135,9	67,5	56	<b>OPEPH135</b>	D-	S-			1.168 €	1.227 €	1.362 €	1.362 €
137↔139	135,9↔137,9	68,5	57	<b>OPEPH137</b>	D-	S-			1.180 €	1.240 €	1.379 €	1.379 €
139↔141	137,9↔139,9	69,5	58	<b>OPEPH139</b>	D-	S-			1.208 €	1.269 €	1.408 €	1.408 €
142↔144	140,9↔142,9	71	59,5	<b>OPEPH142</b>	D-	S-			1.222 €	1.283 €	1.424 €	1.424 €
145↔147	143,9↔145,9	72,5	61	<b>OPEPH145</b>	D-	S-			1.234 €	1.298 €	1.439 €	1.439 €
147↔149	145,9↔147,9	73,5	62	<b>OPEPH147</b>	D-	S-		+ 38 €	1.254 €	1.317 €	1.463 €	1.463 €
149↔151	147,9↔149,9	74,5	63	<b>OPEPH149</b>	D-	S-			1.274 €	1.339 €	1.485 €	1.485 €
152↔154	150,9↔152,9	76	64,5	<b>OPEPH152</b>	D-	S-			1.284 €	1.349 €	1.498 €	1.498 €
155↔157	153,9↔155,9	77,5	66	<b>OPEPH155</b>	D-	S-			1.294 €	1.359 €	1.510 €	1.510 €
157↔159	155,9↔157,9	78,5	67	<b>OPEPH157</b>	D-	S-			1.314 €	1.382 €	1.533 €	1.533 €
159↔161	157,9↔159,9	79,5	68	<b>OPEPH159</b>	D-	S-			1.334 €	1.400 €	1.555 €	1.555 €
162↔164	160,9↔162,9	81	69,5	<b>OPEPH162</b>	D-	S-			1.344 €	1.412 €	1.568 €	1.568 €
165↔167	163,9↔165,9	82,5	71	<b>OPEPH165</b>	D-	S-			1.354 €	1.423 €	1.579 €	1.579 €
167↔169	165,9↔167,9	83,5	72	<b>OPEPH167</b>	D-	S-			1.375 €	1.443 €	1.604 €	1.604 €
169↔171	167,9↔169,9	84,5	73	<b>OPEPH169</b>	D-	S-			1.394 €	1.465 €	1.625 €	1.625 €
175↔177	173,9↔175,9	87,5	76	<b>OPEPH175</b>	D-	S-			1.414 €	1.484 €	1.649 €	1.649 €
177↔179	175,9↔177,9	88,5	77	<b>OPEPH177</b>	D-	S-			1.440 €	1.513 €	1.680 €	1.680 €
179↔181	177,9↔179,9	89,5	78	<b>OPEPH179</b>	D-	S-			1.500 €	1.577 €	1.750 €	1.750 €
195↔197	193,9↔195,9	97,5	86	<b>OPEPH195</b>	D-	S-			1.520 €	1.597 €	1.773 €	1.773 €
197↔199	195,9↔197,9	98,5	87	<b>OPEPH197</b>	D-	S-			1.540 €	1.618 €	1.797 €	1.797 €
199↔201	197,9↔199,9	99,5	88	<b>OPEPH199</b>	D-	S-			1.560 €	1.640 €	1.820 €	1.820 €
<b>PARETE FISSA</b>												
<b>F</b>	<b>G</b>				<b>FD</b>	<b>FS</b>						
67↔69	65,9↔67,9	-	-	<b>OPEFH67</b>	D-	S-			424 €	445 €	494 €	494 €
69↔71	67,9↔69,9	-	-	<b>OPEFH69</b>	D-	S-			449 €	472 €	524 €	524 €
73↔75	71,9↔73,9	-	-	<b>OPEFH73</b>	D-	S-			467 €	492 €	545 €	545 €
75↔77	73,9↔75,9	-	-	<b>OPEFH75</b>	D-	S-			485 €	510 €	568 €	568 €
77↔79	75,9↔77,9	-	-	<b>OPEFH77</b>	D-	S-			510 €	538 €	597 €	597 €
79↔81	77,9↔79,9	-	-	<b>OPEFH79</b>	D-	S-			524 €	550 €	613 €	613 €
85↔87	83,9↔85,9	-	-	<b>OPEFH85</b>	D-	S-			549 €	578 €	640 €	640 €
87↔89	85,9↔87,9	-	-	<b>OPEFH87</b>	D-	S-			560 €	588 €	654 €	654 €
89↔91	87,9↔89,9	-	-	<b>OPEFH89</b>	D-	S-			587 €	617 €	683 €	683 €
95↔97	93,9↔95,9	-	-	<b>OPEFH95</b>	D-	S-		+ 38 €	597 €	628 €	698 €	698 €
97↔99	95,9↔97,9	-	-	<b>OPEFH97</b>	D-	S-			622 €	654 €	725 €	725 €
99↔101	97,9↔99,9	-	-	<b>OPEFH99</b>	D-	S-			635 €	668 €	742 €	742 €
105↔107	103,9↔105,9	-	-	<b>OPEFH105</b>	D-	S-			670 €	704 €	783 €	783 €
107↔109	105,9↔107,9	-	-	<b>OPEFH107</b>	D-	S-			689 €	723 €	803 €	803 €
115↔117	113,9↔115,9	-	-	<b>OPEFH115</b>	D-	S-			705 €	742 €	824 €	824 €
117↔119	115,9↔117,9	-	-	<b>OPEFH117</b>	D-	S-			729 €	767 €	852 €	852 €
119↔121	117,9↔119,9	-	-	<b>OPEFH119</b>	D-	S-			755 €	793 €	880 €	880 €
H = 200				<b>OPEFHSP</b>								
L 53↔119		SPECIAL							909 €	954 €	1.057 €	1.057 €

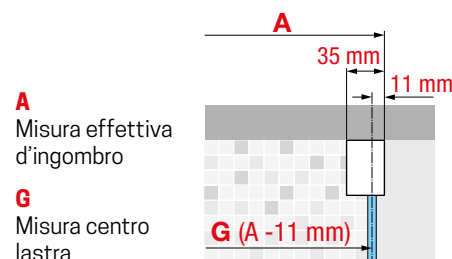
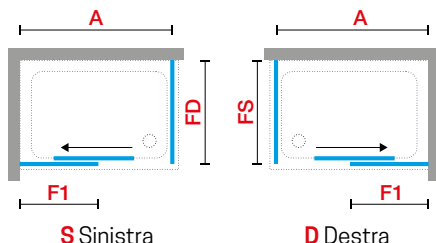
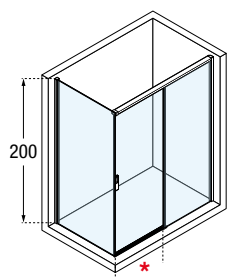



#### FINITURE VETRI



Trasparente  
cod 1

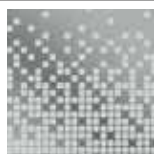

Ser. Ravenna  
cod 51

#### FINITURE PROFILI



Bianco opaco  
cod U

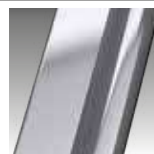

Silver  
cod B



Cromo  
cod K



Nero opaco  
cod H





#### FINITURE VETRI



Trasparente  
cod 1

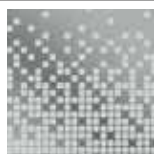

Ser. Ravenna  
cod 51

#### FINITURE PROFILI



Bianco opaco  
cod U

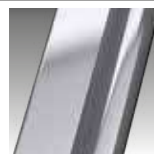

Silver  
cod B



Cromo  
cod K



Nero opaco  
cod H

# OPERA 2PH



200 cm



8 mm



3 cm



Soft closing



## PORTA DOCCIA, APERTURA 1 ANTA SCORREVOLE E 1 ANTA FISSA IN LINEA, IN NICCHIA

Misure			Codice	Destra	Sinistra	Scelta vetro		Scelta profilo			
Misura effettiva d'ingombro	Fisso frontale	Entrata (cm)		D-	S-	1	51	U	B	K	H
<b>A</b>	<b>F1</b>	*				Trasparente	Serigrafia Ravenna	Bianco opaco	Silver	Cromo	Nero opaco
97↔100	51	37	<b>OPE2PH97</b>	D-	S-	+ 38 €		1.073 €	1.128 €	1.252 €	1.252 €
100↔103	52,5	38,5	<b>OPE2PH100</b>	D-	S-			1.158 €	1.217 €	1.352 €	1.352 €
117↔120	61	47	<b>OPE2PH117</b>	D-	S-			1.244 €	1.308 €	1.452 €	1.452 €
120↔123	62,5	48,5	<b>OPE2PH120</b>	D-	S-			1.312 €	1.379 €	1.530 €	1.530 €
137↔140	71	57	<b>OPE2PH137</b>	D-	S-			1.378 €	1.445 €	1.607 €	1.607 €
140↔143	72,5	58,5	<b>OPE2PH140</b>	D-	S-			1.420 €	1.492 €	1.655 €	1.655 €
147↔150	76	62	<b>OPE2PH147</b>	D-	S-			1.463 €	1.535 €	1.704 €	1.704 €
150↔153	77,5	63,5	<b>OPE2PH150</b>	D-	S-			1.483 €	1.558 €	1.730 €	1.730 €
157↔160	81	67	<b>OPE2PH157</b>	D-	S-			1.505 €	1.580 €	1.755 €	1.755 €
160↔163	82,5	68,5	<b>OPE2PH160</b>	D-	S-			1.548 €	1.624 €	1.803 €	1.803 €
167↔170	86	72	<b>OPE2PH167</b>	D-	S-			1.590 €	1.669 €	1.854 €	1.854 €
170↔173	87,5	73,5	<b>OPE2PH170</b>	D-	S-			1.634 €	1.717 €	1.907 €	1.907 €
177↔180	91	77	<b>OPE2PH177</b>	D-	S-			1.679 €	1.763 €	1.957 €	1.957 €
180↔183	92,5	78,5	<b>OPE2PH180</b>	D-	S-			1.722 €	1.808 €	2.007 €	2.007 €
197↔200	101	87	<b>OPE2PH197</b>	D-	S-			1.764 €	1.853 €	2.055 €	2.055 €
200↔203	102,5	88,5	<b>OPE2PH200</b>	D-	S-			1.807 €	1.897 €	2.107 €	2.107 €

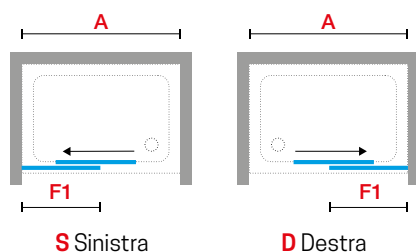
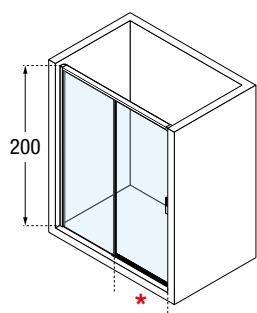





#### FINITURE VETRI



Trasparente  
cod 1

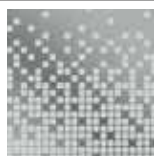

Ser. Ravenna  
cod 51

#### FINITURE PROFILI



Bianco opaco  
cod U

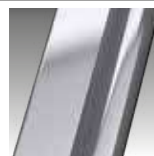

Silver  
cod B



Cromo  
cod K



Nero opaco  
cod H

## BOX DOCCIA AD ANGOLO APERTURA 2 ANTE SCORREVOLI E 2 FISSE

Misure				Codice	Destra D-	Sinistra S-	Scelta vetro		Scelta profilo			
Misura effettiva d'ingombro <b>A</b>	Misura centro lastra <b>G</b>	Fisso frontale <b>F1</b>	Entrata (cm) <b>*</b>				1	51	U	B	K	H
67↔69	65,9↔67,9	33,5	32	<b>OPEA67L</b>	D-	S-	Trasparente	Serigrafia Ravenna	Bianco opaco	Silver	Cromo	Nero opaco
69↔71	67,9↔69,9	34,5	34	<b>OPEA69L</b>	D-	S-	+ 38 €		642 €	675 €	750 €	750 €
75↔77	73,9↔75,9	37,5	38	<b>OPEA75L</b>	D-	S-			669 €	704 €	782 €	782 €
77↔79	75,9↔77,9	38,5	39	<b>OPEA77L</b>	D-	S-			669 €	704 €	782 €	782 €
79↔81	77,9↔79,9	39,5	41	<b>OPEA79L</b>	D-	S-			669 €	704 €	782 €	782 €
85↔87	83,9↔85,9	42,5	45	<b>OPEA85L</b>	D-	S-			699 €	735 €	815 €	815 €
87↔89	85,9↔87,9	43,5	46	<b>OPEA87L</b>	D-	S-			699 €	735 €	815 €	815 €
89↔91	87,9↔89,9	44,5	48	<b>OPEA89L</b>	D-	S-			699 €	735 €	815 €	815 €
95↔97	93,9↔95,9	47,5	52	<b>OPEA95L</b>	D-	S-			725 €	762 €	847 €	847 €
97↔99	95,9↔97,9	48,5	53	<b>OPEA97L</b>	D-	S-			725 €	762 €	847 €	847 €
99↔101	97,9↔99,9	49,5	55	<b>OPEA99L</b>	D-	S-			753 €	792 €	880 €	880 €
115↔117	113,9↔115,9	65,5	58	<b>OPEA115L</b>	D-	S-			835 €	879 €	975 €	975 €
117↔119	115,9↔117,9	66,5	60	<b>OPEA117L</b>	D-	S-			877 €	922 €	1.022 €	1.022 €
119↔121	117,9↔119,9	67,5	62	<b>OPEA119L</b>	D-	S-			877 €	922 €	1.022 €	1.022 €

### PER COMPORRE UN ANGOLO ORDINARE 2 LATI (LATO DESTRO + LATO SINISTRO)

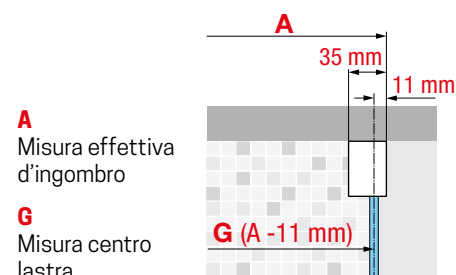
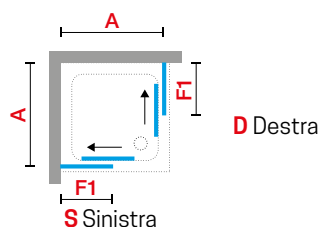
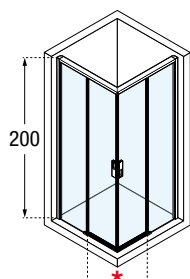



#### FINITURE VETRI



Trasparente  
cod 1

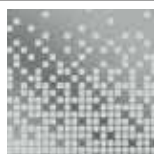

Ser. Ravenna  
cod 51

#### FINITURE PROFILI



Bianco opaco  
cod U

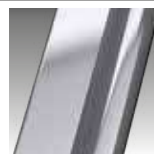

Silver  
cod B



Cromo  
cod K



Nero opaco  
cod H

# OPERA 2A



## PORTA DOCCIA APERTURA 2 ANTE SCORREVOLI E 2 FISSE IN LINEA

Installabile in nicchia o abbinabile ad 1 parete fissa laterale OPERA F

Misure				Codice	Scelta vetro		Scelta profilo			
Misura effettiva d'ingombro	Misura centro lastra	Fisso frontale	Entrata (cm)		1	51	U	B	K	H
<b>A</b>	<b>G</b>	<b>F1</b>	*		Trasparente	Serigrafia Ravenna	Bianco opaco	Silver	Cromo	Nero opaco
<b>PORTA</b>										
117↔121	115,9↔119,9	31	45	<b>OPE2A117-</b>			1.350 €	1.419 €	1.574 €	1.574 €
121↔125	119,9↔123,9	32	47	<b>OPE2A121-</b>			1.350 €	1.419 €	1.574 €	1.574 €
125↔129	123,9↔127,9	33	49	<b>OPE2A125-</b>			1.459 €	1.533 €	1.702 €	1.702 €
129↔133	127,9↔131,9	34	51	<b>OPE2A129-</b>			1.459 €	1.533 €	1.702 €	1.702 €
133↔137	131,9↔135,9	35	53	<b>OPE2A133-</b>			1.459 €	1.533 €	1.702 €	1.702 €
137↔141	135,9↔139,9	36	52	<b>OPE2A137-</b>			1.570 €	1.649 €	1.830 €	1.830 €
141↔145	139,9↔143,9	37	54	<b>OPE2A141-</b>			1.570 €	1.649 €	1.830 €	1.830 €
145↔149	143,9↔147,9	38	56	<b>OPE2A145-</b>			1.570 €	1.649 €	1.830 €	1.830 €
149↔153	147,9↔151,9	39	58	<b>OPE2A149-</b>	+ 76 €		1.624 €	1.705 €	1.894 €	1.894 €
153↔157	151,9↔155,9	40	60	<b>OPE2A153-</b>			1.624 €	1.705 €	1.894 €	1.894 €
157↔161	155,9↔159,9	41	62	<b>OPE2A157-</b>			1.624 €	1.705 €	1.894 €	1.894 €
161↔165	159,9↔163,9	42	64	<b>OPE2A161-</b>			1.680 €	1.764 €	1.958 €	1.958 €
165↔169	163,9↔167,9	43	66	<b>OPE2A165-</b>			1.680 €	1.764 €	1.958 €	1.958 €
169↔173	167,9↔171,9	44	68	<b>OPE2A169-</b>			1.680 €	1.764 €	1.958 €	1.958 €
173↔177	171,9↔175,9	45	70	<b>OPE2A173-</b>			1.737 €	1.824 €	2.027 €	2.027 €
177↔181	175,9↔179,9	46	72	<b>OPE2A177-</b>			1.737 €	1.824 €	2.027 €	2.027 €
197↔201	195,9↔199,9	51	82	<b>OPE2A197-</b>			1.794 €	1.884 €	2.092 €	2.092 €
<b>PARETE FISSA</b>										
<b>F</b>	<b>G</b>									
67↔69	65,9↔67,9			<b>OPEF67-</b>			472 €	495 €	550 €	550 €
69↔71	67,9↔69,9			<b>OPEF69-</b>			500 €	525 €	584 €	584 €
73↔75	71,9↔73,9			<b>OPEF73-</b>			520 €	547 €	608 €	608 €
75↔77	73,9↔75,9			<b>OPEF75-</b>			540 €	568 €	630 €	630 €
77↔79	75,9↔77,9			<b>OPEF77-</b>			568 €	597 €	664 €	664 €
79↔81	77,9↔79,9			<b>OPEF79-</b>			583 €	613 €	679 €	679 €
85↔87	83,9↔85,9			<b>OPEF85-</b>			610 €	640 €	712 €	712 €
87↔89	85,9↔87,9			<b>OPEF87-</b>			623 €	655 €	727 €	727 €
89↔91	87,9↔89,9			<b>OPEF89-</b>	+ 38 €		653 €	684 €	760 €	760 €
95↔97	93,9↔95,9			<b>OPEF95-</b>			664 €	698 €	775 €	775 €
97↔99	95,9↔97,9			<b>OPEF97-</b>			692 €	725 €	805 €	805 €
99↔101	97,9↔99,9			<b>OPEF99-</b>			707 €	743 €	825 €	825 €
105↔107	103,9↔105,9			<b>OPEF105-</b>			745 €	784 €	870 €	870 €
107↔109	105,9↔107,9			<b>OPEF107-</b>			764 €	803 €	892 €	892 €
115↔117	113,9↔115,9			<b>OPEF115-</b>			784 €	824 €	914 €	914 €
117↔119	115,9↔117,9			<b>OPEF117-</b>			810 €	852 €	947 €	947 €
119↔121	117,9↔119,9			<b>OPEF119-</b>			838 €	880 €	978 €	978 €
H = 200 L 67↔119		SPECIAL		<b>OPEFSP</b>	-		1.005 €	1.057 €	1.173 €	1.173 €

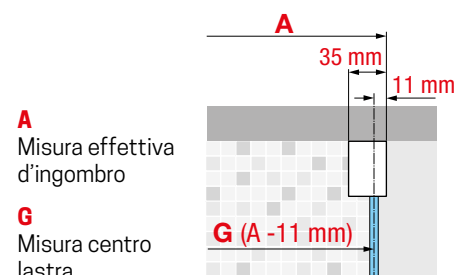
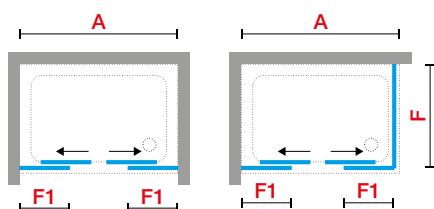
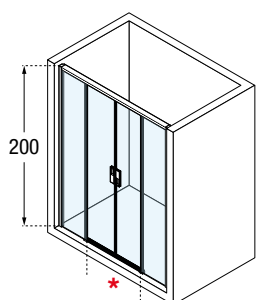



#### FINITURE VETRI



Trasparente  
cod 1

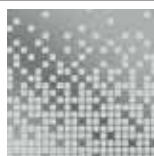

Ser. Ravenna  
cod 51

#### FINITURE PROFILI



Bianco opaco  
cod U

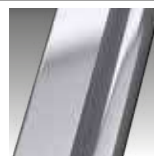

Silver  
cod B



Cromo  
cod K



Nero opaco  
cod H

## DATI TECNICI

### FINITURE PROFILI

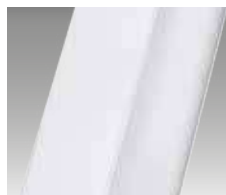

Bianco opaco  
cod. U



Silver  
cod. B



Cromo  
cod. K



Nero opaco  
cod. H

### VETRO TEMPRATO 8 mm (European Standards EN 14428)



Trasparente  
cod. 1



### SERIGRAFIA

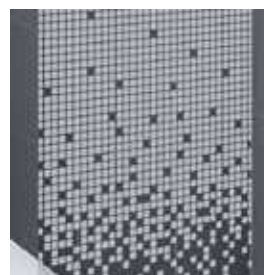

Ravenna  
cod. 51

### MANIGLIA



Maniglia in metallo  
bianca, nera o cromata

### MISURE DI INGOMBRO PROFILI DI FISSAGGIO

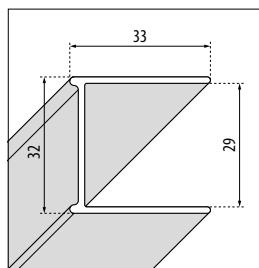

**A MURO**  
per Opera PH - 2P - A - 2PH

Altezza	Finitura	Codice
1999	Bianco	<b>P01BXMOST-U</b>
	Silver	<b>P01BXMOST-B</b>
	Cromo	<b>P01BXMOST-K</b>
	Nero	<b>P01BXMOST-H</b>

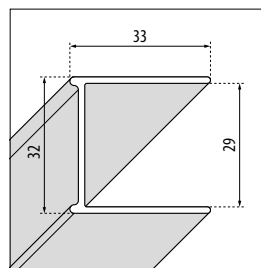

**A MURO**  
per Opera FH

Altezza	Finitura	Codice
2002	Bianco	<b>P01BXFHST-U</b>
	Silver	<b>P01BXFHST-B</b>
	Cromo	<b>P01BXFHST-K</b>
	Nero	<b>P01BXMOST-H</b>

### COME RILEVARE LE MISURE

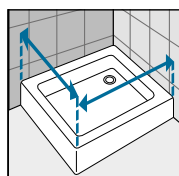

Rilevare le misure da muro a bordo esterno del piatto doccia. Le misure devono essere rilevate sulla parete finita, a rivestimenti posati, secondo gli schemi riportati.

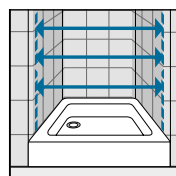

Rilevare le misure da muro a muro, in basso, in alto, al centro e utilizzare quella di valore inferiore. Le misure devono essere rilevate sulla parete finita, a rivestimenti posati, secondo gli schemi riportati.



# KUADRA 2.0

MINIMALISMO GEOMETRICO  
E SENSAZIONI DI BENESSERE.



◀ Scorrimento con nuovo sistema d'incollaggio UV ad alte prestazioni



◀ Regolazione estensibilità e fissaggio a muro a scomparsa



◀ Nuovo sistema di fissaggio Kuadra 2.0 PH+FH

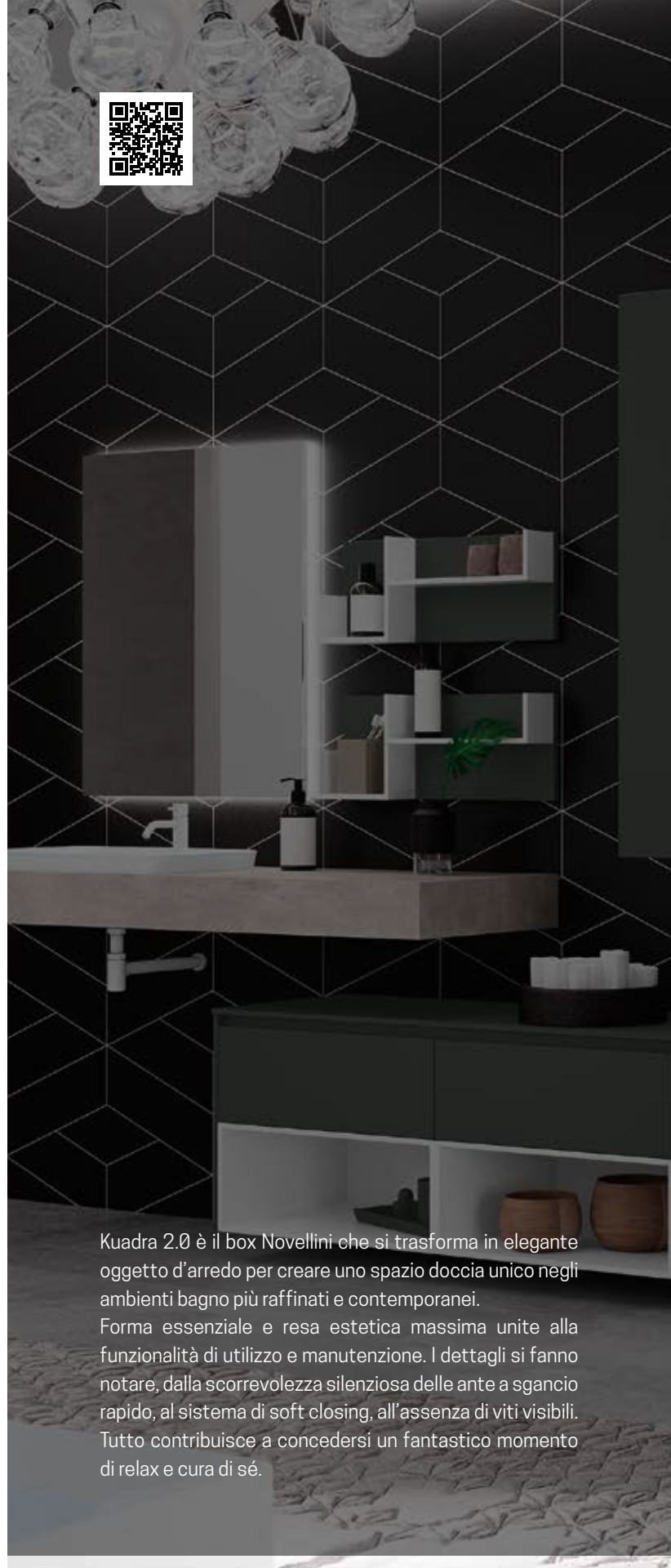

Kuadra 2.0 è il box Novellini che si trasforma in elegante oggetto d'arredo per creare uno spazio doccia unico negli ambienti bagno più raffinati e contemporanei. Forma essenziale e resa estetica massima unite alla funzionalità di utilizzo e manutenzione. I dettagli si fanno notare, dalla scorrevolezza silenziosa delle ante a sgancio rapido, al sistema di soft closing, all'assenza di viti visibili. Tutto contribuisce a concedersi un fantastico momento di relax e cura di sé.

## TRATTAMENTI







# KUADRA 2.0

# KUADRA 2.0 PH+FH



## BOX DOCCIA AD ANGOLO APERTURA 1 ANTA SCORREVOLE E 1 ANTA FISSA IN LINEA CON 1 PARETE FISSA LATERALE

Misure				Codice	Destra	Sinistra	Scelta vetro		Scelta profilo				
Misura effettiva d'ingombro	Misura centro lastra	Fisso frontale	Entrata (cm)		D-	S-	1	56	U	B	K	H	Z
<b>A</b>	<b>G</b>	<b>F1</b>	*				Trasparente	Serigrafia Rose 1	Bianco opaco	Silver	Cromo	Nero opaco	Inox spazzolato
<b>PORTA</b>													
107↔109	106↔108	52	45	<b>K2PH107</b>	D-	S-			877 €	967 €	1.063 €	1.063 €	1.275 €
109↔111	108↔110	54	45	<b>K2PH109</b>	D-	S-			895 €	985 €	1.089 €	1.089 €	1.307 €
117↔119	116↔118	57	50	<b>K2PH117</b>	D-	S-	●		915 €	1.012 €	1.114 €	1.114 €	1.337 €
119↔121	118↔120	59	50	<b>K2PH119</b>	D-	S-			934 €	1.030 €	1.134 €	1.134 €	1.361 €
127↔129	126↔128	62	55	<b>K2PH127</b>	D-	S-			954 €	1.050 €	1.159 €	1.159 €	1.391 €
129↔131	128↔130	64	55	<b>K2PH129</b>	D-	S-			973 €	1.077 €	1.185 €	1.185 €	1.422 €
137↔139	136↔138	67	60	<b>K2PH137</b>	D-	S-	●		993 €	1.095 €	1.205 €	1.205 €	1.446 €
139↔141	138↔140	69	60	<b>K2PH139</b>	D-	S-			1.012 €	1.114 €	1.230 €	1.230 €	1.476 €
147↔149	146↔148	72	65	<b>K2PH147</b>	D-	S-	●	+ 38 €	1.030 €	1.134 €	1.250 €	1.250 €	1.500 €
149↔151	148↔150	74	65	<b>K2PH149</b>	D-	S-			1.057 €	1.167 €	1.288 €	1.288 €	1.545 €
157↔159	156↔158	77	70	<b>K2PH157</b>	D-	S-	●		1.077 €	1.185 €	1.308 €	1.308 €	1.569 €
159↔161	158↔160	79	70	<b>K2PH159</b>	D-	S-			1.089 €	1.198 €	1.320 €	1.320 €	1.584 €
167↔169	166↔168	82	75	<b>K2PH167</b>	D-	S-			1.108 €	1.224 €	1.347 €	1.347 €	1.616 €
169↔171	168↔170	84	75	<b>K2PH169</b>	D-	S-			1.134 €	1.250 €	1.379 €	1.379 €	1.655 €
177↔179	176↔178	87	80	<b>K2PH177</b>	D-	S-			1.159 €	1.275 €	1.404 €	1.404 €	1.685 €
179↔181	178↔180	89	80	<b>K2PH179</b>	D-	S-			1.185 €	1.308 €	1.443 €	1.443 €	1.731 €
H 140↔220				SPECIAL	<b>K2PHSP</b>				1.425 €	1.569 €	1.732 €	1.732 €	2.078 €
L 107↔200													

<b>PARETE FISSA</b>													
<b>F</b>	<b>G</b>												
67↔69	66↔68	-	-	<b>K2FH67-</b>			●		400 €	445 €	490 €	490 €	588 €
69↔71	68↔70	-	-	<b>K2FH69-</b>					400 €	445 €	490 €	490 €	588 €
71↔73	70↔72	-	-	<b>K2FH71-</b>					400 €	445 €	490 €	490 €	588 €
72↔74	71↔73	-	-	<b>K2FH72-</b>					419 €	464 €	515 €	515 €	618 €
74↔76	73↔75	-	-	<b>K2FH74-</b>					419 €	464 €	515 €	515 €	618 €
76↔78	75↔77	-	-	<b>K2FH76-</b>					419 €	464 €	515 €	515 €	618 €
77↔79	76↔78	-	-	<b>K2FH77-</b>			●		439 €	484 €	535 €	535 €	642 €
79↔81	78↔80	-	-	<b>K2FH79-</b>					439 €	484 €	535 €	535 €	642 €
81↔83	80↔82	-	-	<b>K2FH81-</b>					439 €	484 €	535 €	535 €	642 €
85↔87	84↔86	-	-	<b>K2FH85-</b>					464 €	515 €	568 €	568 €	681 €
87↔89	86↔88	-	-	<b>K2FH87-</b>			●		464 €	515 €	568 €	568 €	681 €
89↔91	88↔90	-	-	<b>K2FH89-</b>					464 €	515 €	568 €	568 €	681 €
91↔93	90↔92	-	-	<b>K2FH91-</b>					484 €	535 €	593 €	593 €	711 €
95↔97	94↔96	-	-	<b>K2FH95-</b>				+ 38 €	484 €	535 €	593 €	593 €	711 €
97↔99	96↔98	-	-	<b>K2FH97-</b>					503 €	554 €	613 €	613 €	735 €
99↔101	98↔100	-	-	<b>K2FH99-</b>					503 €	554 €	613 €	613 €	735 €
101↔103	100↔102	-	-	<b>K2FH101-</b>					503 €	554 €	613 €	613 €	735 €
105↔107	104↔106	-	-	<b>K2FH105-</b>					529 €	587 €	652 €	652 €	782 €
107↔109	106↔108	-	-	<b>K2FH107-</b>					529 €	587 €	652 €	652 €	782 €
109↔111	108↔110	-	-	<b>K2FH109-</b>					529 €	587 €	652 €	652 €	782 €
111↔113	110↔112	-	-	<b>K2FH111-</b>					548 €	607 €	670 €	670 €	804 €
115↔117	114↔116	-	-	<b>K2FH115-</b>					548 €	607 €	670 €	670 €	804 €
117↔119	116↔118	-	-	<b>K2FH117-</b>					574 €	632 €	697 €	697 €	836 €
119↔121	118↔120	-	-	<b>K2FH119-</b>					574 €	632 €	697 €	697 €	836 €
121↔123	120↔122	-	-	<b>K2FH121-</b>					574 €	632 €	697 €	697 €	836 €
H 140↔220				SPECIAL	<b>K2FHSP</b>				688 €	757 €	838 €	838 €	1.005 €
L 65↔123													

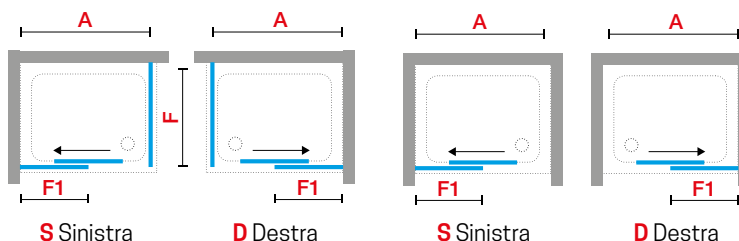
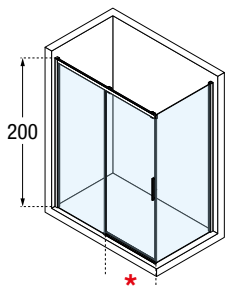

**A** Misura effettiva d'ingombro  
**G** Misura centro lastra

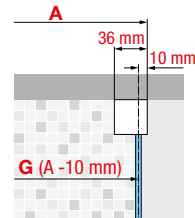

Costruzione del codice

Codice

+ Sinistra/Destra

+

Vetro

+

Profilo

=

Codice prodotto finale



**NOVITÀ!**  
CERNIERE INCOLLATE CON  
COLLA UV AD ALTE PRESTAZIONI



OPTIONAL

**KIT DI MONTAGGIO per versione in nicchia**

Finitura	Installazione	Codice	Prezzo
Bianco opaco	Destra	<b>K2PHPND-U</b>	98 €
Cromo		<b>K2PHPND-K</b>	104 €
Nero opaco		<b>K2PHPND-H</b>	110 €
Inox sp.		<b>K2PHPND-Z</b>	146 €
Bianco opaco	Sinistra	<b>K2PHPNS-U</b>	98 €
Cromo		<b>K2PHPNS-K</b>	104 €
Nero opaco		<b>K2PHPNS-H</b>	110 €
Inox sp.		<b>K2PHPNS-Z</b>	146 €

**FINITURE VETRI**



Trasparente  
cod **1**



Serigrafia Rose 1  
cod **56**

**FINITURE PROFILI**



Bianco opaco  
cod **U**

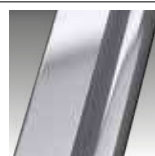

Silver  
cod **B**



Cromo  
cod **K**



Nero opaco  
cod **H**



Inox spazzolato  
cod **Z**

# KUADRA 2.0 2PH



200 cm



8 mm  
Porta



6 mm  
Parete fissa



4 cm



Soft closing



## PORTA DOCCIA, APERTURA 1 ANTA SCORREVOLE E 1 ANTA FISSA IN LINEA

Installabile in nicchia o abbinabile ad 1 parete fissa laterale KUADRA 2.0 F

Misure				Codice	Destra	Sinistra	Scelta vetro		Scelta profilo				
Misura effettiva d'ingombro	Misura centro lastra	Fisso frontale	Entrata (cm)				1	56	U	B	K	H	Z
<b>A</b>	<b>G</b>	<b>F1</b>	*				Trasparente	Serigrafia Rose 1	Bianco opaco	Silver	Cromo	Nero opaco	Inox spazzolato
97↔101	96↔100	47	40	<b>K22PH97</b>	D-	S-			985 €	1.089 €	1.198 €	1.198 €	1.437 €
107↔111	106↔110	52	45	<b>K22PH107</b>	D-	S-			1.030 €	1.134 €	1.250 €	1.250 €	1.500 €
117↔121	116↔120	57	50	<b>K22PH117</b>	D-	S-	●		1.077 €	1.185 €	1.308 €	1.308 €	1.569 €
127↔131	126↔130	62	55	<b>K22PH127</b>	D-	S-			1.122 €	1.237 €	1.365 €	1.365 €	1.638 €
137↔141	136↔140	67	60	<b>K22PH137</b>	D-	S-	●		1.167 €	1.288 €	1.417 €	1.417 €	1.700 €
147↔151	146↔150	72	65	<b>K22PH147</b>	D-	S-	●	+ 38 €	1.212 €	1.334 €	1.469 €	1.469 €	1.763 €
157↔161	156↔160	77	70	<b>K22PH157</b>	D-	S-			1.257 €	1.385 €	1.527 €	1.527 €	1.832 €
167↔171	166↔170	82	75	<b>K22PH167</b>	D-	S-			1.308 €	1.443 €	1.592 €	1.592 €	1.910 €
177↔181	176↔180	87	80	<b>K22PH177</b>	D-	S-			1.359 €	1.500 €	1.655 €	1.655 €	1.986 €
187↔191	186↔190	97	80	<b>K22PH187</b>	D-	S-			1.410 €	1.553 €	1.713 €	1.713 €	2.055 €
H 140↓220 L 97↔200		SPECIAL		<b>K22PHSP</b>	-	-		-	1.694 €	1.863 €	2.063 €	2.063 €	2.475 €

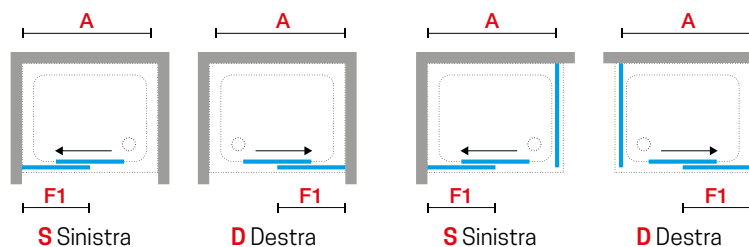
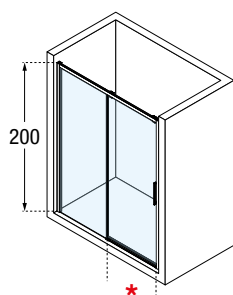

**A**  
Misura effettiva d'ingombro

**G**  
Misura centro lastra

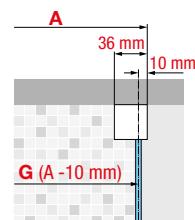

**NOVITÀ!**  
CERNIERE INCOLLATE CON  
COLLA UV AD ALTE PRESTAZIONI



**FINITURE VETRI**



Trasparente  
cod 1



Serigrafia Rose 1  
cod 56

**FINITURE PROFILI**



Bianco opaco  
cod U

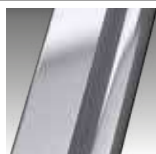

Silver  
cod B



Cromo  
cod K



Nero opaco  
cod H



Inox spazzolato  
cod Z

# KUADRA 2.0 AH



## PORTA DOCCIA APERTURA 2 ANTE SCORREVOLI E 2 FISSE IN LINEA

Misure				Codice	Destra D-	Sinistra S-	Scelta vetro		Scelta profilo				
Misura effettiva d'ingombro	Misura centro lastra	Fisso frontale	Entrata (cm)				1	56	U	B	K	H	Z
<b>A</b>	<b>G</b>	<b>F1</b>	<b>*</b>				Trasparente	Serigrafia Rose 1	Bianco opaco	Silver	Cromo	Nero opaco	Inox spazzolato
67↔69	66↔68	31,5	36	<b>K2AH67L</b>	D-	S-	●	+ 38 €	592 €	650 €	717 €	717 €	860 €
69↔71	68↔70	33,5	37,5	<b>K2AH69L</b>	D-	S-			592 €	650 €	717 €	717 €	860 €
72↔74	71↔73	34,5	40	<b>K2AH72L</b>	D-	S-			604 €	670 €	743 €	743 €	891 €
74↔76	73↔75	36	41,5	<b>K2AH74L</b>	D-	S-			604 €	670 €	743 €	743 €	891 €
77↔79	76↔78	36,5	44	<b>K2AH77L</b>	D-	S-	●		630 €	697 €	769 €	769 €	923 €
79↔81	78↔80	38,5	45,5	<b>K2AH79L</b>	D-	S-			630 €	697 €	769 €	769 €	923 €
87↔89	86↔88	41,5	50	<b>K2AH87L</b>	D-	S-	●		657 €	723 €	795 €	795 €	954 €
89↔91	88↔90	43,5	51,5	<b>K2AH89L</b>	D-	S-			657 €	723 €	795 €	795 €	954 €
97↔99	96↔98	46,5	57	<b>K2AH97L</b>	D-	S-	●		690 €	762 €	840 €	840 €	1.008 €
99↔101	98↔100	48,5	58,5	<b>K2AH99L</b>	D-	S-			690 €	762 €	840 €	840 €	1.008 €
107↔109	106↔108	51,5	64	<b>K2AH107L</b>	D-	S-			723 €	795 €	880 €	880 €	1.056 €
109↔111	108↔110	53,5	65,5	<b>K2AH109L</b>	D-	S-			749 €	828 €	913 €	913 €	1.095 €
117↔119	116↔118	56,6	71	<b>K2AH117L</b>	D-	S-			775 €	854 €	939 €	939 €	1.127 €
119↔121	118↔120	58,5	72,5	<b>K2AH119L</b>	D-	S-			775 €	854 €	939 €	939 €	1.127 €

### PER COMPORRE UN ANGOLO, ORDINARE 2 LATI (LATO DESTRO + LATO SINISTRO)

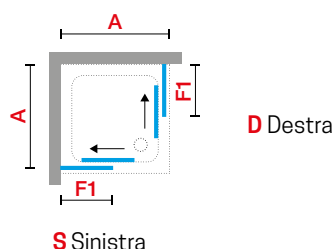
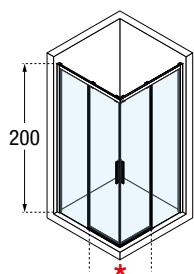

**A**  
Misura effettiva d'ingombro

**G**  
Misura centro lastra

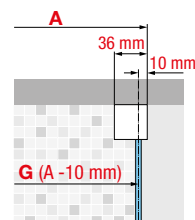

**NOVITÀ!**  
CERNIERE INCOLLATE CON  
COLLA UV AD ALTE PRESTAZIONI



**FINITURE VETRI**



Trasparente  
cod 1



Serigrafia Rose 1  
cod 56

**FINITURE PROFILI**



Bianco opaco  
cod U

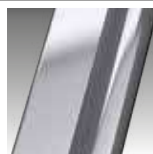

Silver  
cod B



Cromo  
cod K



Nero opaco  
cod H



Inox spazzolato  
cod Z

# KUADRA 2.0 G



## PORTA DOCCIA, APERTURA 1 ANTA BATTENTE

Installabile in nicchia o abbinabile ad 1 parete fissa laterale KUADRA 2.0 F



### FINITURE VETRI

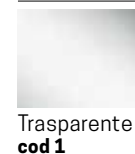

### FINITURE PROFILI

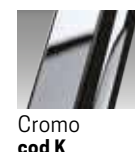
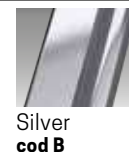
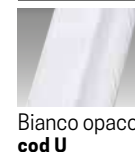

Misure			Codice	Scelta vetro		Scelta profilo				
Misura effettiva d'ingombro	Entrata (cm)	Ingombro anta esterno		1	56	U	B	K	H	Z
<b>A</b>	*	<b>B</b>		Trasparente	Serigrafia Rose 1	Bianco opaco	Silver	Cromo	Nero opaco	Inox spazzolato
67↔71	51	52	<b>K2G67-</b>			832 €	915 €	1.012 €	1.012 €	1.214 €
72↔76	56	57	<b>K2G72-</b>			838 €	922 €	1.018 €	1.018 €	1.221 €
77↔81	61	62	<b>K2G77-</b>		+ 38 €	844 €	934 €	1.030 €	1.030 €	1.236 €
87↔91	68	69	<b>K2G87-</b>			857 €	948 €	1.044 €	1.044 €	1.253 €
97↔101	78	79	<b>K2G97-</b>			870 €	960 €	1.057 €	1.057 €	1.268 €

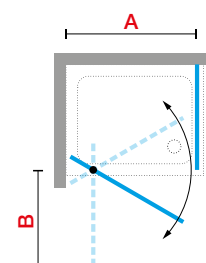
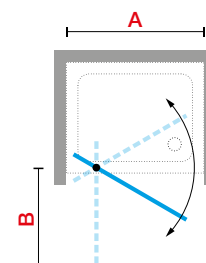
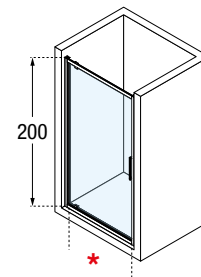



# KUADRA 2.0 2B

## PORTA DOCCIA, APERTURA 2 ANTE BATTENTI

Installabile in nicchia o abbinabile ad 1 parete fissa laterale KUADRA 2.0 F



200 cm



6 mm



4 cm



### FINITURE VETRI



Trasparente  
cod 1



Serigrafia  
Rose 1  
cod 56

### FINITURE PROFILI



Bianco opaco  
cod U



Silver  
cod B



Cromo  
cod K



Nero opaco  
cod H



Inox  
spazzolato  
cod Z

Misure			Codice	Scelta vetro		Scelta profilo				
Misura effettiva d'ingombro	Entrata (cm)	Ingombro anta esterno		1	56	U	B	K	H	Z
<b>A</b>	*	<b>B</b>		Trasparente	Serigrafia Rose 1	Bianco opaco	Silver	Cromo	Nero opaco	Inox spazzolato
67↔71	49	25	<b>K22B67-</b>			889 €	979 €	1.083 €	1.083 €	1.299 €
72↔76	54	28	<b>K22B72-</b>			922 €	1.018 €	1.122 €	1.122 €	1.346 €
77↔81	59	30	<b>K22B77-</b>		+ 38 €	954 €	1.050 €	1.159 €	1.159 €	1.391 €
87↔91	63	32	<b>K22B87-</b>			985 €	1.089 €	1.198 €	1.198 €	1.437 €
97↔101	73	37	<b>K22B97-</b>			1.018 €	1.122 €	1.237 €	1.237 €	1.347 €

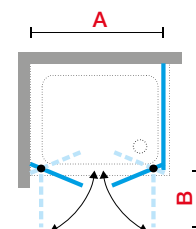
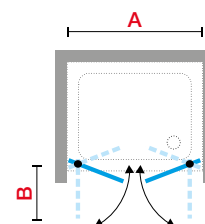
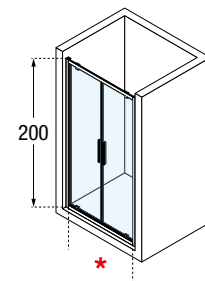

# KUADRA 2.0 G+F IN LINEA



## PORTA DOCCIA APERTURA 1 ANTA BATTENTE E 1 FISSO IN LINEA

Installabile in nicchia o abbinabile ad 1 pannello fisso laterale KUADRA 2.0 F

Misure					Codice	Scelta vetro		Scelta profilo				
Misura effettiva d'ingombro	Misura centro lastra	Fisso frontale	Entrata (cm)	Ingombro anta esterno		1	56	U	B	K	H	Z
<b>A</b>	<b>G</b>	<b>F1</b>	<b>*</b>	<b>B</b>		Trasparente	Serigrafia Rose 1	Bianco opaco	Silver	Cromo	Nero opaco	Inox spazzolato
97↔101	96↔100	31	51	52	<b>K2GFL97-</b>	+ 38 €		1.134 €	1.250 €	1.379 €	1.379 €	1.655 €
107↔111	106↔110	31	61	62	<b>K2GFL107-</b>			1.185 €	1.308 €	1.443 €	1.443 €	1.731 €
113↔117	112↔116	38	61	62	<b>K2GFL113-</b>			1.212 €	1.334 €	1.469 €	1.469 €	1.763 €
117↔121	116↔120	41	61	62	<b>K2GFL117-</b>			1.237 €	1.365 €	1.508 €	1.508 €	1.809 €
127↔131	126↔130	51	61	62	<b>K2GFL127-</b>			1.288 €	1.417 €	1.559 €	1.559 €	1.871 €
137↔141	136↔140	51	68	69	<b>K2GFL137-</b>			1.340 €	1.475 €	1.623 €	1.623 €	1.947 €
147↔151	146↔150	61	68	69	<b>K2GFL147-</b>			1.392 €	1.533 €	1.688 €	1.688 €	2.025 €
153↔157	152↔156	68	68	69	<b>K2GFL153-</b>			1.417 €	1.559 €	1.720 €	1.720 €	2.064 €
157↔161	156↔160	71	68	69	<b>K2GFL157-</b>			1.443 €	1.592 €	1.752 €	1.752 €	2.102 €
163↔167	162↔166	68	78	79	<b>K2GFL163-</b>			1.469 €	1.617 €	1.784 €	1.784 €	2.141 €
167↔171	166↔170	71	78	79	<b>K2GFL167-</b>			1.494 €	1.649 €	1.817 €	1.817 €	2.180 €
177↔181	176↔180	81	78	79	<b>K2GFL177-</b>			1.545 €	1.700 €	1.874 €	1.874 €	2.249 €

PER MISURE OLTRE 153 UTILIZZARE BARRA YOUNG R80GIANF15- (VEDI PAG. 316)

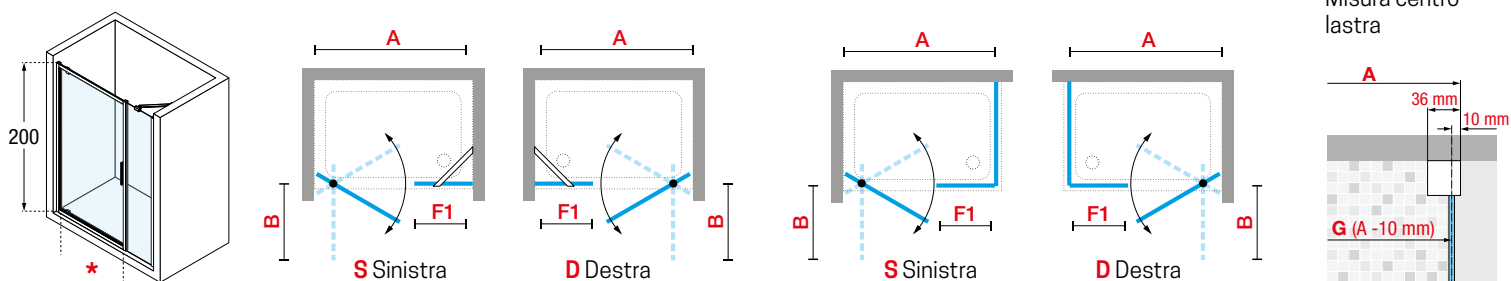



**FINITURE VETRI**



Trasparente  
cod 1



Serigrafia Rose 1  
cod 56

**FINITURE PROFILI**



Bianco opaco  
cod U

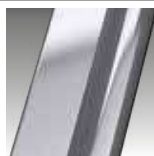

Silver  
cod B



Cromo  
cod K



Nero opaco  
cod H



Inox spazzolato  
cod Z

# KUADRA 2.0 F



## PARETE FISSA LATERALE

Misure		Codice	Scelta vetro		Scelta profilo				
Misura effettiva d'ingombro	Misura centro lastra		1	56	U	B	K	H	Z
<b>F</b>	<b>G</b>		Trasparente	Serigrafia Rose 1	Bianco opaco	Silver	Cromo	Nero opaco	Inox spazzolato
67↔69	66↔68	<b>K2F67-</b>			433 €	478 €	529 €	529 €	635 €
69↔71	68↔70	<b>K2F69-</b>			433 €	478 €	529 €	529 €	635 €
71↔73	70↔72	<b>K2F71-</b>			433 €	478 €	529 €	529 €	635 €
72↔74	71↔73	<b>K2F72-</b>			458 €	509 €	562 €	562 €	674 €
74↔76	73↔75	<b>K2F74-</b>			458 €	509 €	562 €	562 €	674 €
76↔78	75↔77	<b>K2F76-</b>			458 €	509 €	562 €	562 €	674 €
77↔79	76↔78	<b>K2F77-</b>			484 €	535 €	593 €	593 €	711 €
79↔81	78↔80	<b>K2F79-</b>			484 €	535 €	593 €	593 €	711 €
81↔83	80↔82	<b>K2F81-</b>			484 €	535 €	593 €	593 €	711 €
85↔87	84↔86	<b>K2F85-</b>			509 €	562 €	619 €	619 €	743 €
87↔89	86↔88	<b>K2F87-</b>			509 €	562 €	619 €	619 €	743 €
89↔91	88↔90	<b>K2F89-</b>			509 €	562 €	619 €	619 €	743 €
91↔93	90↔92	<b>K2F91-</b>		+ 38 €	535 €	593 €	658 €	658 €	789 €
95↔97	94↔96	<b>K2F95-</b>			535 €	593 €	658 €	658 €	789 €
97↔99	96↔98	<b>K2F97-</b>			535 €	593 €	658 €	658 €	789 €
99↔101	98↔100	<b>K2F99-</b>			562 €	619 €	683 €	683 €	819 €
101↔103	100↔102	<b>K2F101-</b>			562 €	619 €	683 €	683 €	819 €
105↔107	104↔106	<b>K2F105-</b>			562 €	619 €	683 €	683 €	819 €
107↔109	106↔108	<b>K2F107-</b>			587 €	652 €	722 €	722 €	866 €
109↔111	108↔110	<b>K2F109-</b>			587 €	652 €	722 €	722 €	866 €
111↔113	110↔112	<b>K2F111-</b>			587 €	652 €	722 €	722 €	866 €
115↔117	114↔116	<b>K2F115-</b>			599 €	664 €	735 €	735 €	882 €
117↔119	116↔118	<b>K2F117-</b>			599 €	664 €	735 €	735 €	882 €
119↔121	118↔120	<b>K2F119-</b>			625 €	690 €	760 €	760 €	912 €
121↔123	120↔122	<b>K2F121-</b>			625 €	690 €	760 €	760 €	912 €
H 140↑220 L 20↔121 SPECIAL		<b>K2FSP</b>		-	750 €	832 €	913 €	913 €	1.095 €

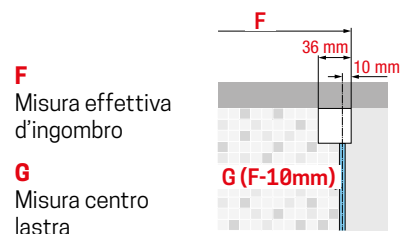
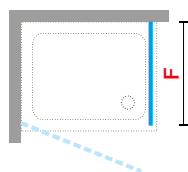
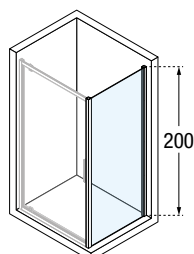



**FINITURE VETRI**



Trasparente  
cod 1



Serigrafia Rose 1  
cod 56

**FINITURE PROFILI**



Bianco opaco  
cod U

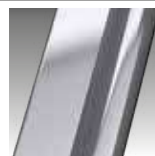

Silver  
cod B



Cromo  
cod K



Nero opaco  
cod H



Inox spazzolato  
cod Z

# KUADRA 2.0 2AH



## PORTA DOCCIA APERTURA 2 ANTE SCORREVOLI E 2 FISSE IN LINEA

Installabile in nicchia o abbinabile ad 1 parete fissa laterale KUADRA 2.0 F



### FINITURE VETRI



### FINITURE PROFILI



Misure				Codice	Scelta vetro		Scelta profilo				
Misura effettiva d'ingombro	Misura centro lastra	Fisso frontale	Entrata (cm)		1	56	U	B	K	H	Z
<b>A</b>	<b>G</b>	<b>F1</b>	*		Trasparente	Serigrafia Rose 1	Bianco opaco	Silver	Cromo	Nero opaco	Inox spazzolato
137↔141	136↔140	33	56	<b>K22AH137-</b>			1.458 €	1.609 €	1.773 €	1.773 €	2.127 €
147↔151	146↔150	36,5	60	<b>K22AH147-</b>			1.504 €	1.654 €	1.825 €	1.825 €	2.190 €
157↔161	156↔160	38,5	66	<b>K22AH157-</b>			1.549 €	1.707 €	1.878 €	1.878 €	2.253 €
167↔171	166↔170	41,5	70	<b>K22AH167-</b>		+ 38 €	1.595 €	1.759 €	1.937 €	1.937 €	2.324 €
177↔181	176↔180	43,5	76	<b>K22AH177-</b>			1.642 €	1.805 €	1.989 €	1.989 €	2.387 €
187↔191	186↔190	46,5	80	<b>K22AH187-</b>			1.694 €	1.864 €	2.055 €	2.055 €	2.466 €
197↔201	196↔200	48,5	86	<b>K22AH197-</b>			1.747 €	1.924 €	2.120 €	2.120 €	2.544 €

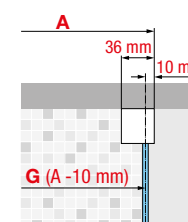
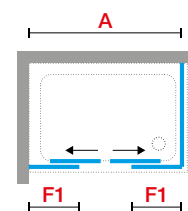
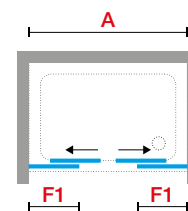
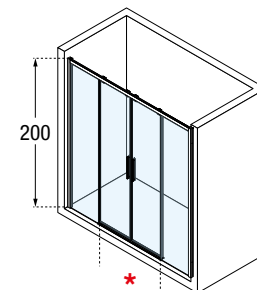

**A** Misura effettiva d'ingombro  
**G** Misura centro lastra

## DATI TECNICI

### FINITURE PROFILI



Bianco opaco  
cod. U



Silver  
cod. B



Cromo  
cod. K



Nero opaco  
cod. H



Inox spazzolato  
cod. Z

### VETRO TEMPRATO 8 mm (European Standards EN 14428)



Trasparente  
cod. 1



### SERIGRAFIA

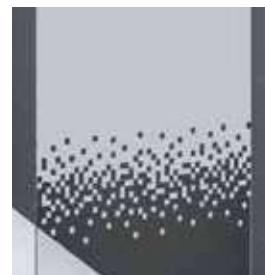

Serigrafia Rose 1  
cod. 56

### MANIGLIA



Maniglia metallica

### MISURE DI INGOMBRO PROFILI DI FISSAGGIO

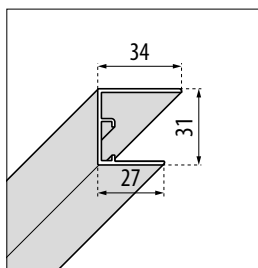

**A MURO**  
per tutti i modelli

Altezza	Finitura	Codice
2000	Bianco opaco	<b>P01BWMOST-U</b>
	Silver	<b>P01BWMOST-B</b>
	Nero	<b>P01BWMOST-H</b>
	Cromo	<b>P01BWMOST-K</b>
	Inox sp.	<b>P01BWMOST-Z</b>

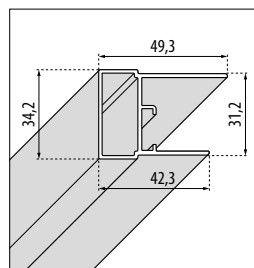

**COMPENSAZIONE**  
per tutti i modelli

Altezza	Finitura	Codice
2000	Bianco opaco	<b>P05BWMOST-U</b>
	Silver	<b>P05BWMOST-B</b>
	Nero	<b>P05BWMOST-H</b>
	Cromo	<b>P05BWMOST-K</b>
	Inox sp.	<b>P05BWMOST-Z</b>

### COME RILEVARE LE MISURE

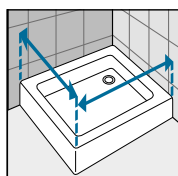

Rilevare le misure da muro a bordo esterno del piatto doccia. Le misure devono essere rilevate sulla parete finita, a rivestimenti posati, secondo gli schemi riportati.

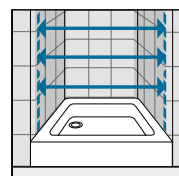

Rilevare le misure da muro a muro, in basso, in alto, al centro e utilizzare quella di valore inferiore. Le misure devono essere rilevate sulla parete finita, a rivestimenti posati, secondo gli schemi riportati.

# ROSE ROSSE

IL GRANDE MINIMALISMO  
DAL TOCCO VERSATILE.



◀ Nuova maniglia in vetro



◀ Tecnica e funzionalità



◀ ROSE EVO  
Sistema di sgancio ante  
scorrevoli  
Per i modelli: A - 2P - PH - 2A



Un box doccia che soddisfa il desiderio di personalizzazione su ambienti bagno definiti da grandi spazi e dal gusto contemporaneo.

Rose Rosse è la scelta minimal in linea con i trend di arredo più in voga: docce lineari con ampi cristalli personalizzabili che creano una superficie quasi ininterrotta con la pavimentazione. Il kit per lo sgancio rapido dell'anta e il nuovo profilo di tenuta di soli 4mm permettono una ancor migliore facilità di pulizia e manutenzione.

## TRATTAMENTI







# ROSE ROSSE

# ROSE ROSSE A



## BOX DOCCIA AD ANGOLO APERTURA 2 ANTE SCORREVOLI E 2 FISSE IN LINEA

Misure				Codice	Destra	Sinistra	Scelta vetro				Scelta profilo		
Misura effettiva d'ingombro	Misura centro lastra	Fisso frontale	Entrata (cm)		D-	S-	1	4	56	57	D	B	K
A	G	F1	*				Trasparente	Satinato	Serigrafia Rose 1	Serigrafia Rose 2	Bianco	Silver	Cromo
67↔70	65,6↔68,6	30	34	<b>ROSEA68L</b>	D-	S-	●				512 €	558 €	609 €
70↔73	68,6↔71,6	31	36	<b>ROSEA71L</b>	D-	S-					512 €	558 €	609 €
72↔75	70,6↔73,6	32	37,5	<b>ROSEA73L</b>	D-	S-					527 €	575 €	627 €
74↔77	72,6↔75,6	33	39	<b>ROSEA75L</b>	D-	S-					527 €	575 €	627 €
77↔80	75,6↔78,6	35	41	<b>ROSEA78L</b>	D-	S-	●				540 €	589 €	642 €
80↔83	78,6↔81,6	36	43	<b>ROSEA81L</b>	D-	S-					540 €	589 €	642 €
82↔85	80,6↔83,6	37	44,5	<b>ROSEA83L</b>	D-	S-					540 €	589 €	642 €
84↔87	82,6↔85,6	38	46	<b>ROSEA85L</b>	D-	S-					540 €	589 €	642 €
87↔90	85,6↔88,6	40	48	<b>ROSEA88L</b>	D-	S-	●				554 €	605 €	660 €
90↔93	88,6↔91,6	41	50	<b>ROSEA91L</b>	D-	S-					554 €	605 €	660 €
92↔95	90,6↔93,6	42	51,5	<b>ROSEA93L</b>	D-	S-					568 €	620 €	675 €
94↔97	92,6↔95,6	43	53	<b>ROSEA95L</b>	D-	S-		+ 38 €	+ 38 €	+ 38 €	568 €	620 €	675 €
97↔100	95,6↔98,6	45	55	<b>ROSEA98L</b>	D-	S-	●				583 €	635 €	694 €
100↔103	98,6↔101,6	46	57	<b>ROSEA101L</b>	D-	S-					583 €	635 €	694 €
102↔105	100,6↔103,6	48	57	<b>ROSEA103L</b>	D-	S-					595 €	652 €	709 €
104↔107	102,6↔105,6	50	57	<b>ROSEA105L</b>	D-	S-					595 €	652 €	709 €
107↔110	105,6↔108,6	53	57	<b>ROSEA108L</b>	D-	S-					610 €	667 €	727 €
110↔113	108,6↔111,6	56	57	<b>ROSEA111L</b>	D-	S-					610 €	667 €	727 €
112↔115	110,6↔113,6	58	57	<b>ROSEA113L</b>	D-	S-					625 €	682 €	744 €
114↔117	112,6↔115,6	60	57	<b>ROSEA115L</b>	D-	S-					625 €	682 €	744 €
117↔120	115,6↔118,6	63	57	<b>ROSEA118L</b>	D-	S-					638 €	698 €	759 €
127↔130	125,6↔128,6	73	57	<b>ROSEA128L</b>	D-	S-					668 €	728 €	794 €
137↔140	135,6↔138,6	83	57	<b>ROSEA138L</b>	D-	S-					697 €	758 €	828 €

### PER COMPORRE UN ANGOLO ORDINARE 2 LATI (1 LATO DESTRO + 1 LATO SINISTRO)

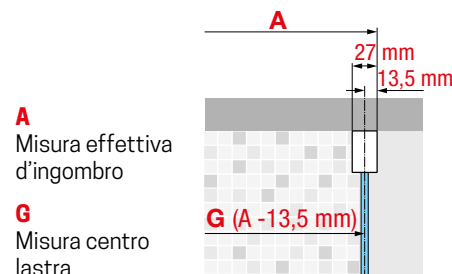
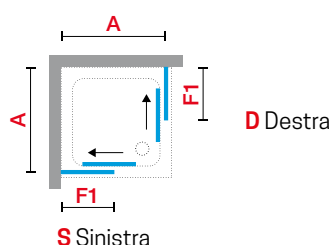
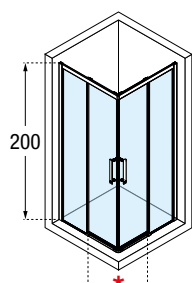



#### FINITURE VETRI



Trasparente  
cod 1



Satin  
cod 4



Ser. Rose 1  
cod 56



Ser. Rose 2  
cod 57

#### FINITURE PROFILI



Bianco  
cod D

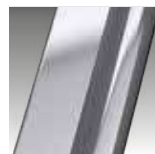

Silver  
cod B



Cromo  
cod K

# ROSE ROSSE 2P



## PORTA DOCCIA APERTURA 1 ANTA SCORREVOLE E 1 FISSA IN LINEA

Installabile in nicchia o abbinabile ad 1 parete fissa laterale ROSE F

Misure				Codice	Destra	Sinistra	Scelta vetro				Scelta profilo		
Misura effettiva d'ingombro	Misura centro lastra	Fisso frontale	Entrata (cm)				1	4	56	57	D	B	K
A	G	F1	*		D-	S-	Trasparente	Satinato	Serigrafia Rose 1	Serigrafia Rose 2	Bianco	Silver	Cromo
96↔102	94,6↔100,6	44	37,5	<b>ROSE2P96</b>	D-	S-					880 €	968 €	1.064 €
114↔120	112,6↔118,6	53	46	<b>ROSE2P114</b>	D-	S-	●				880 €	968 €	1.064 €
116↔122	114,6↔120,6	54	47	<b>ROSE2P116</b>	D-	S-	●		●		880 €	968 €	1.064 €
121↔127	119,6↔125,6	57	49,5	<b>ROSE2P121</b>	D-	S-					908 €	999 €	1.098 €
126↔132	124,6↔130,6	59	52	<b>ROSE2P126</b>	D-	S-					908 €	999 €	1.098 €
131↔137	129,6↔135,6	61	54,5	<b>ROSE2P131</b>	D-	S-					935 €	1.030 €	1.134 €
136↔142	134,6↔140,6	64	57	<b>ROSE2P136</b>	D-	S-	●		●		935 €	1.030 €	1.134 €
141↔147	139,6↔145,6	66	59,5	<b>ROSE2P141</b>	D-	S-					965 €	1.062 €	1.169 €
146↔152	144,6↔150,6	69	62	<b>ROSE2P146</b>	D-	S-					965 €	1.062 €	1.169 €
151↔157	149,6↔155,6	74	62	<b>ROSE2P151</b>	D-	S-		+ 38 €	+ 38 €	+ 38 €	993 €	1.092 €	1.200 €
156↔162	154,6↔160,6	79	62	<b>ROSE2P156</b>	D-	S-	●		●		993 €	1.092 €	1.200 €
161↔167	159,6↔165,6	84	62	<b>ROSE2P161</b>	D-	S-					1.020 €	1.124 €	1.237 €
166↔172	164,6↔170,6	89	62	<b>ROSE2P166</b>	D-	S-					1.020 €	1.124 €	1.237 €
171↔177	169,6↔175,6	94	62	<b>ROSE2P171</b>	D-	S-					1.049 €	1.154 €	1.270 €
176↔182	174,6↔180,6	99	62	<b>ROSE2P176</b>	D-	S-					1.049 €	1.154 €	1.270 €
181↔187	179,6↔185,6	104	62	<b>ROSE2P181</b>	D-	S-					1.078 €	1.185 €	1.304 €
186↔192	184,6↔190,6	109	62	<b>ROSE2P186</b>	D-	S-					1.078 €	1.185 €	1.304 €
191↔197	189,6↔195,6	114	62	<b>ROSE2P191</b>	D-	S-					1.092 €	1.200 €	1.320 €
196↔202	194,6↔200,6	119	62	<b>ROSE2P196</b>	D-	S-					1.092 €	1.200 €	1.320 €

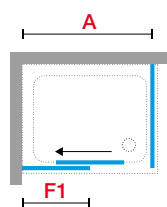
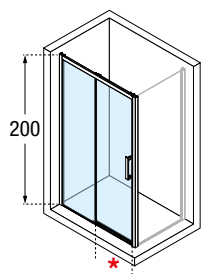

S Sinistra

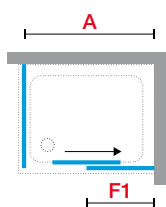

D Destra

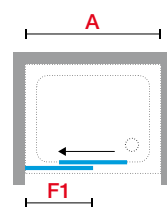

S Sinistra

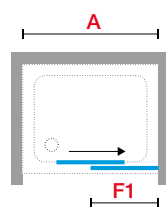

D Destra

**A**  
Misura effettiva d'ingombro

**G**  
Misura centro lastra

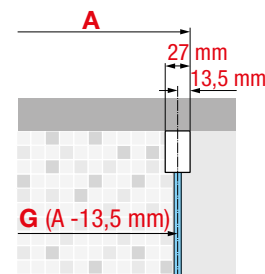



#### FINITURE VETRI



Trasparente  
cod 1

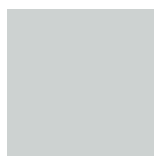

Satin  
cod 4



Ser. Rose 1  
cod 56



Ser. Rose 2  
cod 57

#### FINITURE PROFILI



Bianco  
cod D

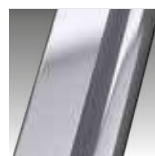

Silver  
cod B



Cromo  
cod K

# ROSE ROSSE PH+FH



## BOX DOCCIA AD ANGOLO APERTURA 1 ANTA SCORREVOLE E 1 ANTA FISSA IN LINEA CON 1 PARETE FISSA LATERALE

Installabile in nicchia o abbinabile ad 1 parete fissa laterale ROSE FH

Misure					Codice	Destra	Sinistra	Scelta vetro				Scelta profilo			
Misura effettiva d'ingombro con fisso	Misura centro lastra	In nicchia	Fisso frontale	Entrata (cm)		D-	S-	1	4	56	57	D	B	K	
A	G	A1	F1	*				Trasparente	Satinato	Serigrafia Rose 1	Serigrafia Rose 2	Bianco	Silver	Cromo	
<b>PORTA</b>															
117↔120	115,6↔118,6	115↔118	62	47	<b>ROSEPH117</b>	D-	S-	●					767 €	844 €	929 €
120↔123	118,6↔121,6	118↔121	65	47	<b>ROSEPH120</b>	D-	S-						767 €	844 €	929 €
123↔126	121,6↔124,6	121↔124	68	47	<b>ROSEPH123</b>	D-	S-						767 €	844 €	929 €
126↔129	124,6↔127,6	124↔127	71	47	<b>ROSEPH126</b>	D-	S-						767 €	844 €	929 €
127↔130	125,6↔128,6	125↔128	67	52	<b>ROSEPH127</b>	D-	S-						767 €	844 €	929 €
129↔132	127,6↔130,6	127↔130	69	52	<b>ROSEPH129</b>	D-	S-						767 €	844 €	929 €
132↔135	130,6↔133,6	130↔133	72	52	<b>ROSEPH132</b>	D-	S-						767 €	844 €	929 €
135↔138	133,6↔136,6	133↔136	75	52	<b>ROSEPH135</b>	D-	S-						767 €	844 €	929 €
137↔140	135,6↔138,6	135↔138	72	57	<b>ROSEPH137</b>	D-	S-	●					850 €	935 €	1.030 €
138↔141	136,6↔139,6	136↔139	73	57	<b>ROSEPH138</b>	D-	S-						850 €	935 €	1.030 €
141↔144	139,6↔142,6	139↔142	76	57	<b>ROSEPH141</b>	D-	S-						850 €	935 €	1.030 €
144↔147	142,6↔145,6	142↔145	79	57	<b>ROSEPH144</b>	D-	S-						850 €	935 €	1.030 €
147↔150	145,6↔148,6	145↔148	77	62	<b>ROSEPH147</b>	D-	S-		+38 €	+38 €	+38 €		850 €	935 €	1.030 €
150↔153	148,6↔151,6	148↔151	80	62	<b>ROSEPH150</b>	D-	S-						850 €	935 €	1.030 €
153↔156	151,6↔154,6	151↔154	83	62	<b>ROSEPH153</b>	D-	S-						850 €	935 €	1.030 €
156↔159	154,6↔157,6	154↔157	86	62	<b>ROSEPH156</b>	D-	S-						850 €	935 €	1.030 €
157↔160	155,6↔158,6	155↔158	82	67	<b>ROSEPH157</b>	D-	S-						893 €	982 €	1.082 €
159↔162	157,6↔160,6	157↔160	84	67	<b>ROSEPH159</b>	D-	S-						893 €	982 €	1.082 €
162↔165	160,6↔163,6	160↔163	87	67	<b>ROSEPH162</b>	D-	S-						893 €	982 €	1.082 €
165↔168	163,6↔166,6	163↔166	90	67	<b>ROSEPH165</b>	D-	S-						893 €	982 €	1.082 €
167↔170	165,6↔168,6	165↔168	92	67	<b>ROSEPH167</b>	D-	S-						893 €	982 €	1.082 €
171↔174	169,6↔172,6	169↔172	96	67	<b>ROSEPH171</b>	D-	S-						935 €	1.030 €	1.134 €
174↔177	172,6↔175,6	172↔175	99	67	<b>ROSEPH174</b>	D-	S-						935 €	1.030 €	1.134 €
177↔180	175,6↔178,6	175↔178	102	67	<b>ROSEPH177</b>	D-	S-						935 €	1.030 €	1.134 €

## OPTIONAL - KIT DI CHIUSURA CON PROFILI MAGNETICI PER VERSIONE IN NICCHIA

					KROSPHPN-					A	B	K		
Misura effettiva d'ingombro	Misura centro lastra		Fisso frontale	Entrata (cm)		D-	S-	1	4	56	57	D	B	K
F	G		F1	*				Trasparente	Satinato	Serigrafia Rose 1	Serigrafia Rose 2	Bianco	Silver	Cromo
								-	-	-	-	89 €	95 €	102 €

## PARETE FISSA LATERALE ABBINATA REVERSIBILE

68↔71	66,6↔69,6	-	-	-	<b>ROSEFH68-</b>			●				299 €	328 €	359 €
71↔74	69,6↔72,6	-	-	-	<b>ROSEFH71-</b>							299 €	328 €	359 €
74↔77	72,6↔75,6	-	-	-	<b>ROSEFH74-</b>							314 €	342 €	374 €
76↔79	74,6↔77,6	-	-	-	<b>ROSEFH76-</b>			●				314 €	342 €	374 €
78↔81	76,6↔79,6	-	-	-	<b>ROSEFH78-</b>			●	+38 €	-	-	314 €	342 €	374 €
88↔91	86,6↔89,6	-	-	-	<b>ROSEFH88-</b>							328 €	359 €	393 €
98↔101	96,6↔99,6	-	-	-	<b>ROSEFH98-</b>							342 €	374 €	409 €
108↔111	106,6↔109,6	-	-	-	<b>ROSEFH108-</b>							358 €	392 €	427 €
118↔121	116,6↔119,6	-	-	-	<b>ROSEFH118-</b>							373 €	408 €	445 €

## PARETE FISSA LATERALE ABBINATA SERIGRAFATO NON REVERSIBILE

68↔71	66,6↔69,6	-	-	-	<b>ROSEFH68</b>	D-	S-					299 €	328 €	359 €
71↔74	69,6↔72,6	-	-	-	<b>ROSEFH71</b>	D-	S-					299 €	328 €	359 €
74↔77	72,6↔75,6	-	-	-	<b>ROSEFH74</b>	D-	S-					314 €	342 €	374 €
76↔79	74,6↔77,6	-	-	-	<b>ROSEFH76</b>	D-	S-					314 €	342 €	374 €
78↔81	76,6↔79,6	-	-	-	<b>ROSEFH78</b>	D-	S-					314 €	342 €	374 €
88↔91	86,6↔89,6	-	-	-	<b>ROSEFH88</b>	D-	S-					328 €	359 €	393 €
98↔101	96,6↔99,6	-	-	-	<b>ROSEFH98</b>	D-	S-			+38 €	+38 €	342 €	374 €	409 €
108↔111	106,6↔109,6	-	-	-	<b>ROSEFH108</b>	D-	S-					358 €	392 €	427 €
118↔121	116,6↔119,6	-	-	-	<b>ROSEFH118</b>	D-	S-					373 €	408 €	445 €

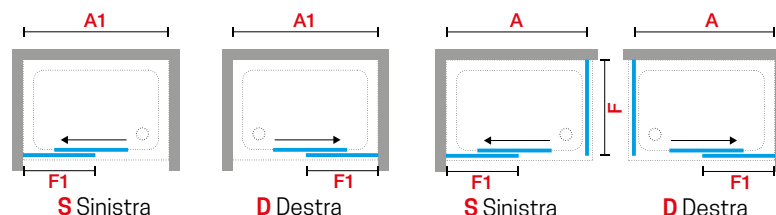
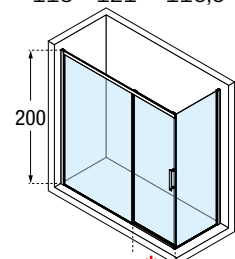

**A** Misura effettiva d'ingombro  
**G** Misura centro lastra

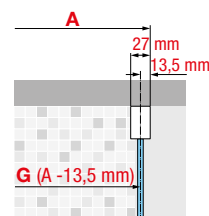



SISTEMA AGGANCO VETRO

## FINITURE VETRI

Trasparente  
cod 1Satin  
cod 4Ser. Rose 1  
cod 56Ser. Rose 2  
cod 57

## FINITURE PROFILI

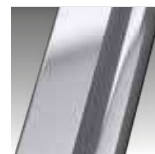
Bianco  
cod DSilver  
cod BCromo  
cod K

# ROSE ROSSE PHB



200 cm 6 mm Porta 8 mm Fisso 3 cm

**BOX DOCCIA AD ANGOLO, APERTURA 1 ANTA SCORREVOLE E 1 FISSA IN LINEA CON BARRA LATERALE**



## FINITURE VETRI



## FINITURE PROFILI



Misure		Codice	Destra	Sinistra	Scelta vetro				Scelta profilo		
Misura effettiva d'ingombro	Fisso frontale				D-	S-	1	4	56	57	D
<b>A</b>	<b>F1</b>				Trasparente	Satinato	Serigrafia Rose 1	Serigrafia Rose 2	Bianco	Silver	Cromo
117↔120	63	<b>ROSEPHB117</b>	D-	S-					815 €	889 €	969 €
127↔130	68	<b>ROSEPHB127</b>	D-	S-					815 €	889 €	969 €
137↔140	73	<b>ROSEPHB137</b>	D-	S-					900 €	982 €	1.072 €
147↔150	78	<b>ROSEPHB147</b>	D-	S-		+ 38 €	+ 38 €	+ 38 €	900 €	982 €	1.072 €
157↔160	83	<b>ROSEPHB157</b>	D-	S-					942 €	1.027 €	1.122 €
167↔170	93	<b>ROSEPHB167</b>	D-	S-					942 €	1.027 €	1.122 €
177↔180	103	<b>ROSEPHB177</b>	D-	S-					984 €	1.075 €	1.172 €

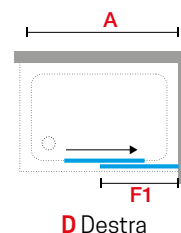
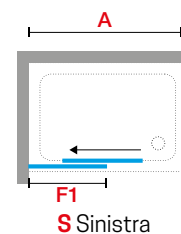
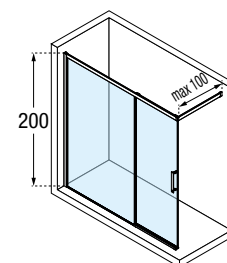



# ROSE ROSSE 2M



200 cm



6 mm



6 cm



## PORTA DOCCIA, APERTURA 2 ANTE SCORREVOLI BILATERALE DA DESTRA E DA SINISTRA

Installabile in nicchia o abbinabile ad 1 parete fissa laterale ROSE ROSSE F



### FINITURE VETRI



Trasparente  
cod 1

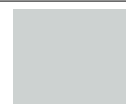

Satin  
cod 4



Ser. Rose 1  
cod 56



Ser. Rose 2  
cod 57

### FINITURE PROFILI



Bianco  
cod D



Silver  
cod B



Cromo  
cod K

Misure		Codice	Scelta vetro				Scelta profilo		
Misura effettiva d'ingombro	Entrata (cm)		1	4	56	57	D	B	K
<b>A</b>	*		Trasparente	Satinato	Serigrafia Rose 1	Serigrafia Rose 2	Bianco	Silver	Cromo
116↔122	43	<b>ROSE2M116-</b>					935 €	1.030 €	1.134 €
126↔132	48	<b>ROSE2M126-</b>					935 €	1.030 €	1.134 €
136↔142	53	<b>ROSE2M136-</b>					993 €	1.092 €	1.200 €
146↔152	58	<b>ROSE2M146-</b>		+ 38 €	+ 38 €	+ 38 €	993 €	1.092 €	1.200 €
156↔162	63	<b>ROSE2M156-</b>					1.049 €	1.154 €	1.270 €
166↔172	68	<b>ROSE2M166-</b>					1.049 €	1.154 €	1.270 €
176↔182	73	<b>ROSE2M176-</b>					1.107 €	1.217 €	1.340 €

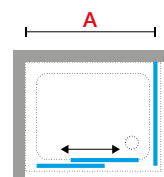
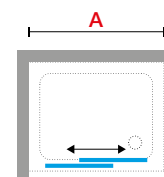
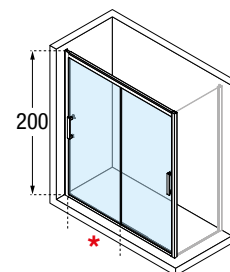

# ROSE ROSSE G



## PORTA DOCCIA, APERTURA 1 ANTA BATTENTE

Installabile in nicchia o abbinabile ad 1 o 2 pareti fisse laterali ROSE F

Misure			Codice	Scelta vetro				Scelta profilo		
Misura effettiva d'ingombro	Ingombro anta esterno	Entrata (cm)		1	4	56	57	D	B	K
<b>A</b>	<b>B</b>	*		Trasparente	Satinato	Serigrafia Rose 1	Serigrafia Rose 2	Bianco	Silver	Cromo
66↔72	47	46	<b>ROSEG66-</b>					709 €	782 €	860 €
72↔78	53	52	<b>ROSEG72-</b>					723 €	797 €	877 €
78↔84	59	58	<b>ROSEG78-</b>					723 €	797 €	877 €
84↔90	66	65	<b>ROSEG84-</b>		+ 38 €	+ 38 €	+ 38 €	739 €	813 €	894 €
90↔96	71	70	<b>ROSEG90-</b>					752 €	828 €	910 €
96↔102	77	76	<b>ROSEG96-</b>					752 €	828 €	910 €

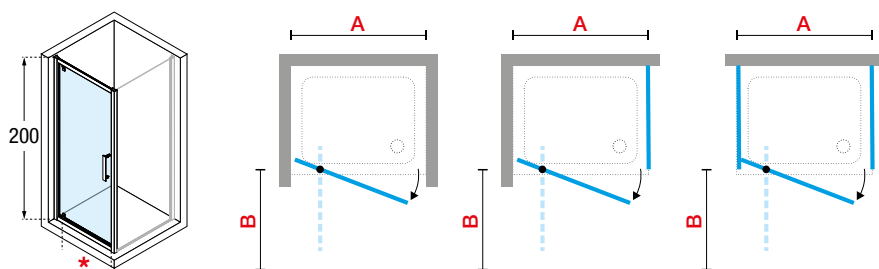



## FINITURE VETRI

Trasparente  
cod 1Satin  
cod 4Ser. Rose 1  
cod 56Ser. Rose 2  
cod 57

## FINITURE PROFILI

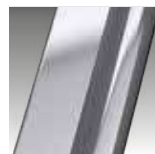
Bianco  
cod DSilver  
cod BCromo  
cod K

# ROSE ROSSE 3PH+FH



## PORTA DOCCIA, APERTURA 3 ANTE, 2 SCORREVOLI + 1 FISSA

Installabile in nicchia o abbinabile ad 1 parete fissa laterale ROSE FH

Misure				Codice	Destra	Sinistra	Scelta vetro				Scelta profilo		
Misura effettiva d'ingombro con fisso	Misura centro lastra	In nicchia	Entrata (cm)		D-	S-	1	4	56	57	D	B	K
A	G	B	*				Trasparente	Satinato	Serigrafia Rose 1	Serigrafia Rose 2	Bianco	Silver	Cromo
80-83	78,6↔81,6	78↔81	41	ROSE3PH78	D-	S-					773 €	850 €	940 €
83-86	81,6↔84,6	81↔84	43	ROSE3PH81	D-	S-					773 €	850 €	940 €
86-89	84,6↔87,6	84↔87	45	ROSE3PH84	D-	S-					819 €	902 €	993 €
89-92	87,6↔90,6	87↔90	47	ROSE3PH87	D-	S-					819 €	902 €	993 €
92-95	90,6↔93,6	90↔93	49	ROSE3PH90	D-	S-					819 €	902 €	993 €
95-98	93,6↔96,6	93↔96	51	ROSE3PH93	D-	S-					844 €	934 €	1.030 €
98-101	96,6↔99,6	96↔99	53	ROSE3PH96	D-	S-					844 €	934 €	1.030 €
101-104	99,6↔102,6	99↔102	55	ROSE3PH99	D-	S-					844 €	934 €	1.030 €
104-107	102,6↔105,6	102↔105	57	ROSE3PH102	D-	S-					883 €	973 €	1.069 €
107-110	105,6↔108,6	105↔108	59	ROSE3PH105	D-	S-					883 €	973 €	1.069 €
110-113	108,6↔111,6	108↔111	61	ROSE3PH108	D-	S-					883 €	973 €	1.069 €
113-116	111,6↔114,6	111↔114	63	ROSE3PH111	D-	S-		+ 38 €	+ 38 €	+ 38 €	909 €	1.005 €	1.108 €
116-119	114,6↔117,6	114↔117	65	ROSE3PH114	D-	S-					909 €	1.005 €	1.108 €
119-122	117,6↔120,6	117↔120	67	ROSE3PH117	D-	S-					948 €	1.044 €	1.153 €
122-125	120,6↔123,6	120↔123	69	ROSE3PH120	D-	S-					948 €	1.044 €	1.153 €
125-128	123,6↔126,6	123↔126	71	ROSE3PH123	D-	S-					948 €	1.044 €	1.153 €
128-131	126,6↔129,6	126↔129	73	ROSE3PH126	D-	S-					985 €	1.089 €	1.198 €
129-132	127,6↔130,6	127↔130	74	ROSE3PH127	D-	S-					985 €	1.089 €	1.198 €
131-134	129,6↔132,6	129↔132	75	ROSE3PH129	D-	S-					985 €	1.089 €	1.198 €
134-137	132,6↔135,6	132↔135	77	ROSE3PH132	D-	S-					1.018 €	1.122 €	1.237 €
137-140	135,6↔138,6	135↔138	79	ROSE3PH135	D-	S-					1.018 €	1.122 €	1.237 €
139-142	137,6↔140,6	137↔140	81	ROSE3PH137	D-	S-					1.057 €	1.167 €	1.282 €
140-143	138,6↔141,6	138↔141	81	ROSE3PH138	D-	S-					1.057 €	1.167 €	1.282 €

Misura effettiva d'ingombro	Entrata (cm)	D-	S-	1	4	56	57	D	B	K
F	G			Trasparente	Satinato	Serigrafia Rose 1	Serigrafia Rose 2	Bianco	Silver	Cromo

PARETE FISSA LATERALE ABBINATA REVERSIBILE												
68↔71	66,6↔69,6	-	-	ROSEFH68-			•			299 €	328 €	359 €
71↔74	69,6↔72,6	-	-	ROSEFH71-						299 €	328 €	359 €
74↔77	72,6↔75,6	-	-	ROSEFH74-						314 €	342 €	374 €
76↔79	74,6↔77,6	-	-	ROSEFH76-						314 €	342 €	374 €
78↔81	76,6↔79,6	-	-	ROSEFH78-	-	-	•	+ 38 €	-	314 €	342 €	374 €
88↔91	86,6↔89,6	-	-	ROSEFH88-			•			328 €	359 €	393 €
98↔101	96,6↔99,6	-	-	ROSEFH98-						342 €	374 €	409 €
108↔111	106,6↔109,6	-	-	ROSEFH108-						358 €	392 €	427 €
118↔121	116,6↔119,6	-	-	ROSEFH118-						373 €	408 €	445 €

PARETE FISSA LATERALE ABBINATA SERIGRAFATO NON REVERSIBILE													
68↔71	66,6↔69,6	-	-	ROSEFH68	D-	S-				299 €	328 €	359 €	
71↔74	69,6↔72,6	-	-	ROSEFH71	D-	S-				299 €	328 €	359 €	
74↔77	72,6↔75,6	-	-	ROSEFH74	D-	S-				314 €	342 €	374 €	
76↔79	74,6↔77,6	-	-	ROSEFH76	D-	S-				314 €	342 €	374 €	
78↔81	76,6↔79,6	-	-	ROSEFH78	D-	S-			38 €	+ 38 €	314 €	342 €	374 €
88↔91	86,6↔89,6	-	-	ROSEFH88	D-	S-				328 €	359 €	393 €	
98↔101	96,6↔99,6	-	-	ROSEFH98	D-	S-				342 €	374 €	409 €	
108↔111	106,6↔109,6	-	-	ROSEFH108	D-	S-				358 €	392 €	427 €	
118↔121	116,6↔119,6	-	-	ROSEFH118	D-	S-				373 €	408 €	445 €	

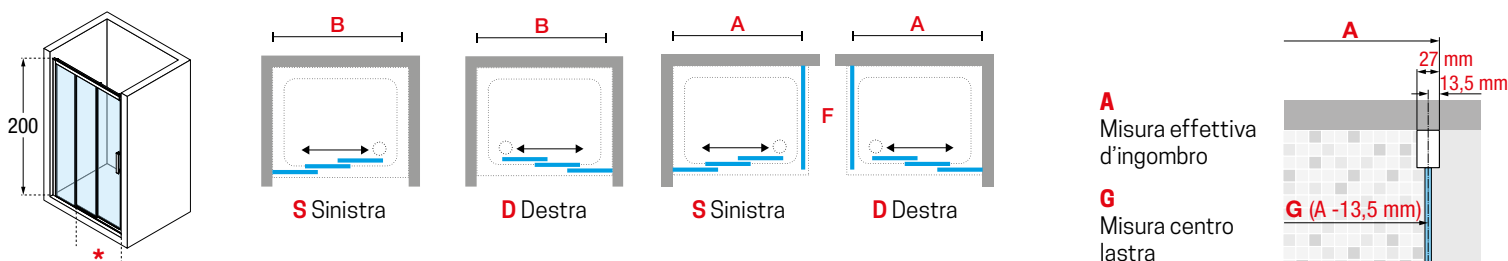



#### FINITURE VETRI



Trasparente  
cod 1



Satin  
cod 4



Ser. Rose 1  
cod 56



Ser. Rose 2  
cod 57

#### FINITURE PROFILI



Bianco  
cod D

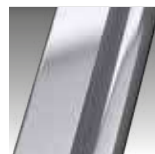

Silver  
cod B



Cromo  
cod K

# ROSE ROSSE 3P



200 cm



6 mm



6 cm



## PORTA DOCCIA APERTURA 3 ANTE SCORREVOLI BILATERALE DA DESTRA E DA SINISTRA

Installabile in nicchia o abbinabile ad 1 o 2 pareti fisse laterali ROSE F



### FINITURE VETRI



Trasparente  
cod 1

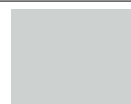

Satin  
cod 4



Ser. Rose 1  
cod 56



Ser. Rose 2  
cod 57

### FINITURE PROFILI



Bianco  
cod D



Silver  
cod B



Cromo  
cod K

Misure		Codice	Scelta vetro				Scelta profilo		
Misura effettiva d'ingombro	Entrata (cm)		1	4	56	57	D	B	K
<b>A</b>	*		Trasparente	Satinato	Serigrafia Rose 1	Serigrafia Rose 2	Bianco	Silver	Cromo
76↔82	36	<b>ROSE3P76-</b>					809 €	890 €	979 €
86↔92	34	<b>ROSE3P86-</b>					837 €	922 €	1.013 €
96↔102	40	<b>ROSE3P96-</b>					880 €	968 €	1.064 €
106↔112	47	<b>ROSE3P106-</b>					923 €	1.015 €	1.119 €
116↔122	54	<b>ROSE3P116-</b>					965 €	1.062 €	1.169 €
126↔132	60	<b>ROSE3P126-</b>		+ 38 €	+ 38 €	+ 38 €	1.007 €	1.108 €	1.218 €
136↔142	67	<b>ROSE3P136-</b>					1.049 €	1.154 €	1.270 €
146↔152	73	<b>ROSE3P146-</b>					1.078 €	1.185 €	1.304 €
156↔162	80	<b>ROSE3P156-</b>					1.120 €	1.232 €	1.355 €
166↔172	86	<b>ROSE3P166-</b>					1.163 €	1.279 €	1.407 €
176↔182	93	<b>ROSE3P176-</b>					1.205 €	1.325 €	1.459 €

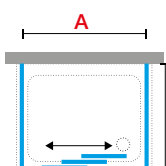
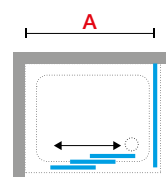
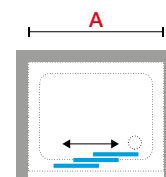
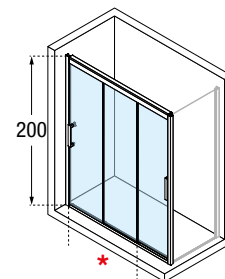

# ROSE ROSSE S



## PORTA DOCCIA, APERTURA 2 ANTE A SOFFIETTO

Installabile in nicchia o abbinabile ad 1 o 2 pareti fisse laterali ROSE F



### FINITURE VETRI



Trasparente  
cod 1

Satin  
cod 4



Ser. Rose 1  
cod 56

Ser. Rose 2  
cod 57

### FINITURE PROFILI



Bianco  
cod D

Silver  
cod B



Cromo  
cod K

Misure			Codice	Scelta vetro				Scelta profilo		
Misura effettiva d'ingombro	Ingombro anta	Entrata (cm)		1	4	56	57	D	B	K
<b>A</b>	<b>B</b>	<b>*</b>		Trasparente	Satinato	Serigrafia Rose 1	Serigrafia Rose 2	Bianco	Silver	Cromo
66↔72	30	47	<b>ROSES66-</b>					739 €	813 €	894 €
72↔78	33	53	<b>ROSES72-</b>					752 €	828 €	910 €
78↔84	36	59	<b>ROSES78-</b>					767 €	844 €	929 €
84↔90	39	65	<b>ROSES84-</b>		+ 38 €	+ 38 €	+ 38 €	794 €	874 €	963 €
90↔96	42	71	<b>ROSES90-</b>					809 €	890 €	979 €
96↔102	45	77	<b>ROSES96-</b>					809 €	890 €	979 €

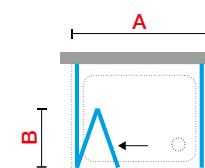
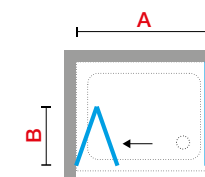
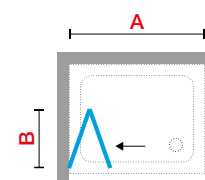
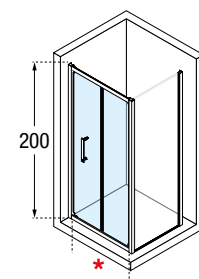

Costruzione del codice **Codice** + **Vetro** + **Profilo** = Codice prodotto finale

# ROSE ROSSE B



200 cm



6 mm



6 cm



## PORTA DOCCIA, APERTURA 2 ANTE BATTENTI

Installabile in nicchia o abbinabile ad 1 o 2 pareti fisse laterali ROSE F



### FINITURE VETRI



Trasparente  
cod 1

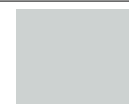

Satin  
cod 4



Ser. Rose 1  
cod 56



Ser. Rose 2  
cod 57

### FINITURE PROFILI



Bianco  
cod D



Silver  
cod B



Cromo  
cod K

Misure			Codice	Scelta vetro				Scelta profilo		
Misura effettiva d'ingombro	Ingombro anta esterno	Entrata (cm)		1	4	56	57	D	B	K
<b>A</b>	<b>B</b>	*		Trasparente	Satinato	Serigrafia Rose 1	Serigrafia Rose 2	Bianco	Silver	Cromo
66↔72	22	45	<b>ROSEB66-</b>					752 €	828 €	910 €
72↔78	26	51	<b>ROSEB72-</b>					782 €	860 €	947 €
78↔84	29	57	<b>ROSEB78-</b>					809 €	890 €	979 €
84↔90	31	63	<b>ROSEB84-</b>		+ 38 €	+ 38 €	+ 38 €	823 €	905 €	997 €
90↔96	36	69	<b>ROSEB90-</b>					850 €	935 €	1.030 €
96↔102	41	75	<b>ROSEB96-</b>					880 €	968 €	1.064 €

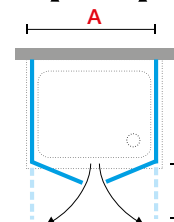
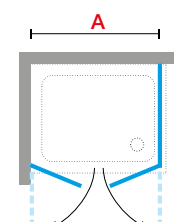
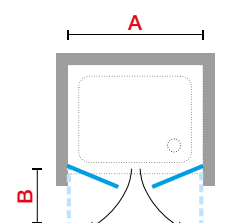
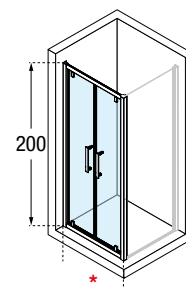



# ROSE ROSSE R

BOX DOCCIA AD ANGOLO SEMICIRCOLARE, APERTURA 2 ANTE SCORREVOLI E 2 FISSE



200 cm



6 mm



3 cm



## FINITURE VETRI



Trasparente  
cod 1

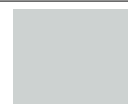

Satin  
cod 4



Ser. Rose 1  
cod 56



Ser. Rose 2  
cod 57

## FINITURE PROFILI



Bianco  
cod D



Silver  
cod B



Cromo  
cod K

Misure						Codice	Destra Sinistra		Scelta vetro				Scelta profilo		
Misura effettiva d'ingombro	Misura centro lastra	Misura effettiva d'ingombro	Fisso frontale	Entrata (cm)	*		D-	S-	1	4	56	57	D	B	K
A	G	B	F1	F2	*			Traspa- rente	Satinato	Serigrafia Rose 1	Serigrafia Rose 2	Bianco	Silver	Cromo	
76,5↔79,5	75,1↔78,1	-	23	-	38	<b>ROSER80-</b>	-	-					1.275 €	1.403 €	1.544 €
86,5↔89,5	85,1↔88,1	-	33	-	51	<b>ROSER90-</b>	-	-	+76 €	+76 €	+76 €		1.348 €	1.482 €	1.630 €
96,5↔99,5	95,1↔98,1	-	43	-	51	<b>ROSER100-</b>	-	-					1.402 €	1.543 €	1.698 €
VERSIONE ASIMMETRICA															
76,5↔79,5	75,1↔78,1	96↔99,5	23	43	44	<b>ROSER80100</b>	D-	S-					1.347 €	1.480 €	1.628 €
76,5↔79,5	75,1↔78,1	116,5↔119,5	23	63	44	<b>ROSER80120</b>	D-	S-	+76 €	+76 €	+76 €		1.403 €	1.544 €	1.699 €
86,5↔89,5	85,1↔88,1	96↔99,5	33	43	51	<b>ROSER90100</b>	D-	S-					1.375 €	1.512 €	1.663 €
86,5↔89,5	85,1↔88,1	116,5↔119,5	33	63	51	<b>ROSER90120</b>	D-	S-					1.433 €	1.577 €	1.735 €

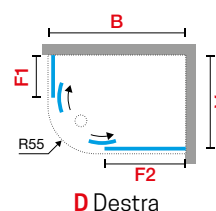
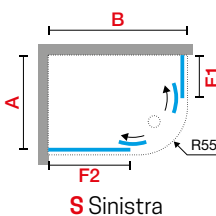
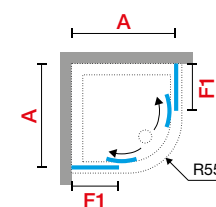
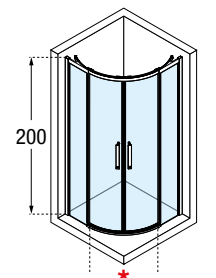

VERSIONE ASIMMETRICA SOLO PER INSTALLAZIONE A PAVIMENTO

**A**  
Misura effettiva  
d'ingombro

**G**  
Misura centro  
lastra

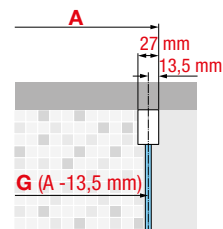

Costruzione  
del codice

Codice

+

Sinistra/Destra

+

Vetro

+

Profilo

=

Codice  
prodotto finale

MISURE SPECIALI:  
CONSEGNA 6 SETTIMANE



# ROSE ROSSE 2A



200 cm



6 mm



6 cm



## PORTA DOCCIA APERTURA 2 ANTE SCORREVOLI E 2 FISSE IN LINEA

Installabile in nicchia o abbinabile ad 1 parete fissa laterale ROSE F



### FINITURE VETRI



Trasparente  
cod 1

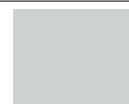

Satin  
cod 4



Ser. Rose 1  
cod 56



Ser. Rose 2  
cod 57

### FINITURE PROFILI



Bianco  
cod D



Silver  
cod B



Cromo  
cod K

Misure				Codice	Scelta vetro				Scelta profilo		
Misura effettiva d'ingombro	Misura centro lastra	Fisso frontale	Entrata (cm)		1	4	56	57	D	B	K
<b>A</b>	<b>G</b>	<b>F1</b>	*		Trasparente	Satinato	Serigrafia Rose 1	Serigrafia Rose 2	Bianco	Silver	Cromo
116↔122	114,6↔120,6	27	42	<b>ROSE2A116-</b>					1.190 €	1.310 €	1.442 €
126↔132	124,6↔130,6	29	47	<b>ROSE2A126-</b>					1.233 €	1.357 €	1.493 €
136↔142	134,6↔140,6	32	52	<b>ROSE2A136-</b>					1.274 €	1.402 €	1.543 €
146↔152	144,6↔150,6	34	57	<b>ROSE2A146-</b>					1.317 €	1.449 €	1.594 €
156↔162	154,6↔160,6	37	62	<b>ROSE2A156-</b>		+76 €	+76 €	+76 €	1.347 €	1.480 €	1.628 €
166↔172	164,6↔170,6	39	67	<b>ROSE2A166-</b>					1.389 €	1.529 €	1.683 €
176↔182	174,6↔180,6	42	72	<b>ROSE2A176-</b>					1.432 €	1.575 €	1.734 €
186↔192	184,6↔190,6	44	77	<b>ROSE2A186-</b>					1.474 €	1.622 €	1.784 €
196↔202	194,6↔200,6	47	82	<b>ROSE2A196-</b>					1.517 €	1.668 €	1.837 €

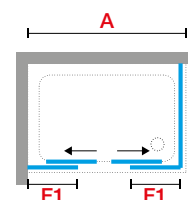
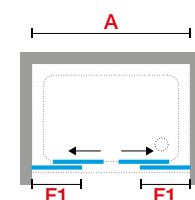
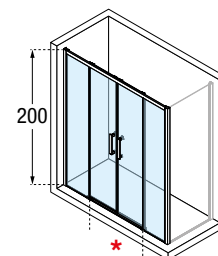

**A**  
Misura effettiva d'ingombro

**G**  
Misura centro lastra

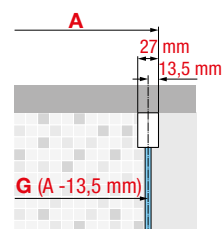

**G MISURA CENTRO LASTRA SOLO QUANDO È ABBINATO AD UN FISSO**

# ROSE ROSSE F

## PARETE FISSA LATERALE



200 cm



6 mm



3 cm



### FINITURE VETRI



Trasparente  
cod 1

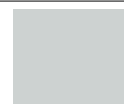

Satin  
cod 4



Ser. Rose 1  
cod 56



Ser. Rose 2  
cod 57

### FINITURE PROFILI



Bianco  
cod D



Silver  
cod B



Cromo  
cod K

Misure		Codice	Scelta vetro				Scelta profilo		
Misura effettiva d'ingombro	Misura centro lastra		1	4	56	57	D	B	K
<b>F</b>	<b>G</b>		Trasparente	Satinato	Serigrafia Rose 1	Serigrafia Rose 2	Bianco	Silver	Cromo
66↔69	64,6↔67,6	<b>ROSEF66-</b>	●		●		370 €	408 €	449 €
68↔71	66,6↔69,6	<b>ROSEF68-</b>	●		●		370 €	408 €	449 €
71↔74	69,6↔72,6	<b>ROSEF71-</b>					385 €	424 €	467 €
73↔76	71,6↔74,6	<b>ROSEF73-</b>					385 €	424 €	467 €
75↔78	73,6↔76,6	<b>ROSEF75-</b>					399 €	439 €	483 €
78↔81	76,6↔79,6	<b>ROSEF78-</b>	●		●		399 €	439 €	483 €
81↔84	79,6↔82,6	<b>ROSEF81-</b>					399 €	439 €	483 €
83↔86	81,6↔84,6	<b>ROSEF83-</b>					399 €	439 €	483 €
85↔88	83,6↔86,6	<b>ROSEF85-</b>		+ 38 €	+ 38 €	+ 38 €	412 €	453 €	499 €
88↔91	86,6↔89,6	<b>ROSEF88-</b>	●		●		412 €	453 €	499 €
91↔94	89,6↔92,6	<b>ROSEF91-</b>					412 €	453 €	499 €
93↔96	91,6↔94,6	<b>ROSEF93-</b>					412 €	453 €	499 €
95↔98	93,6↔96,6	<b>ROSEF95-</b>					427 €	469 €	518 €
98↔101	96,6↔99,6	<b>ROSEF98-</b>					427 €	469 €	518 €
108↔111	106,6↔109,6	<b>ROSEF108-</b>					443 €	487 €	537 €
118↔121	116,6↔119,6	<b>ROSEF118-</b>					458 €	503 €	555 €

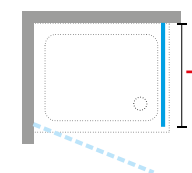
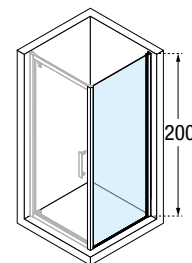

**PER LE SOLUZIONI CON DUE PANNELLI FISSI LATERALI  
UTILIZZARE SEMPRE 2 BARRE DI SOSTEGNO AD ANGOLO.**

**A**  
Misura effettiva d'ingombro

**G**  
Misura centro lastra

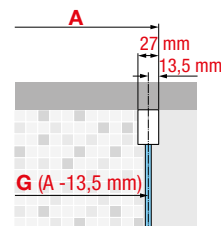

Costruzione del codice

Codice

+

Vetro

+

Profilo

=

Codice prodotto finale



# ROSE ROSSE F SPECIAL 1

PARETE FISSA SPECIALE, SPECIALE IN LARGHEZZA



## FINITURE VETRI



Trasparente  
cod 1

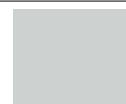

Satin  
cod 4

## FINITURE PROFILI



Bianco  
cod D



Silver  
cod B



Cromo  
cod K

Misure	Codice	Scelta vetro		Scelta profilo		
		1	4	D	B	K
Misura effettiva d'ingombro		Trasparente	Satinato	Bianco	Silver	Cromo
<b>F</b>	<b>ROSEF1SP</b>		+ 38 €	690 €	759 €	835 €

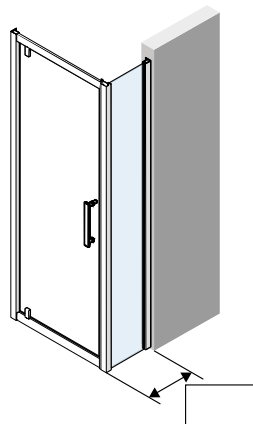
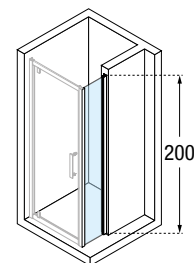

PER LA FATTIBILITÀ DELLE MISURE SPECIALI CONTATTARE IL SERVIZIO CLIENTI O CONSULTARE [HTTP://STORE.NOVELLINI.COM](http://store.novellini.com)

# ROSE ROSSE F SPECIAL 2

PARETE FISSA SPECIALE, SAGOMATA 5 LATI



6 mm



3 cm



## FINITURE VETRI



Trasparente  
cod 1

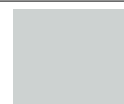

Satin  
cod 4

## FINITURE PROFILI



Bianco  
cod D



Silver  
cod B



Cromo  
cod K

Misure	Codice	Scelta vetro		Scelta profilo		
Misura effettiva d'ingombro		1	4	D	B	K
<b>F</b>		Trasparente	Satinato	Bianco	Silver	Cromo
60↔96	<b>ROSEF2SP</b>		+ 38 €	804 €	885 €	974 €

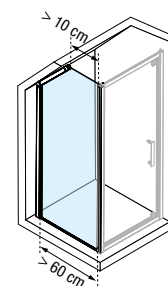

**S** Sinistra

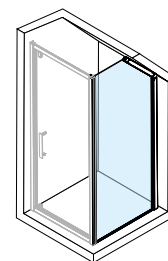

**D** Destra

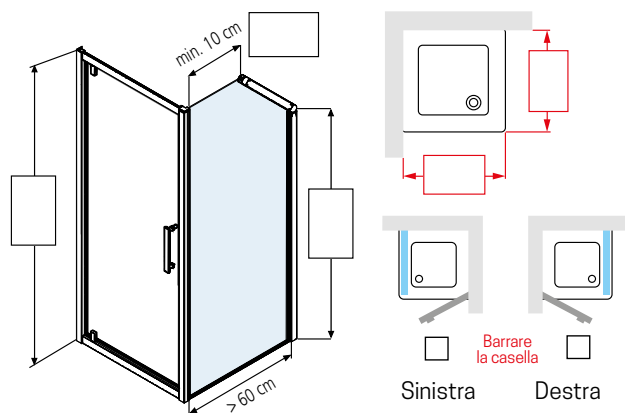

PER LA FATTIBILITÀ DELLE MISURE SPECIALI CONTATTARE IL SERVIZIO CLIENTI O CONSULTARE [HTTP://STORE.NOVELLINI.COM](http://store.novellini.com)

Costruzione del codice **Codice** + **Vetro** + **Profilo** = Codice prodotto finale

# ROSE ROSSE F SPECIAL 3

PARETE FISSA SPECIALE, SAGOMATA 6 LATI



6 mm



3 cm



## FINITURE VETRI



Trasparente  
cod 1

Satin  
cod 4

## FINITURE PROFILI



Bianco  
cod D

Silver  
cod B



Cromo  
cod K

Misure	Codice	Scelta vetro		Scelta profilo		
Misura effettiva d'ingombro		1	4	D	B	K
<b>F</b>		Trasparente	Satinato	Bianco	Silver	Cromo
62↔96	<b>ROSEF3SP</b>		+ 38 €	804 €	885 €	974 €

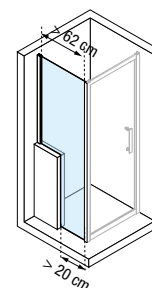

**S** Sinistra

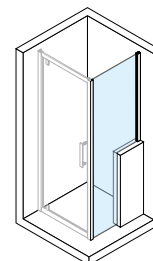

**D** Destra

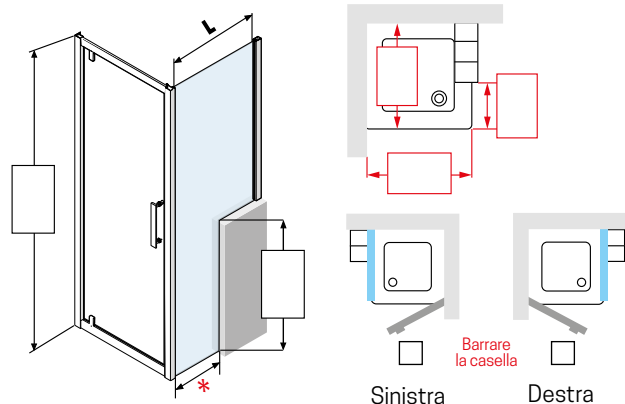

\*  $\geq L/3$ : LA QUOTA DI \* DEVE ESSERE MAGGIORE DI 1/3 DELLA LUCE SUPERIORE E COMUNQUE NON INFERIORE A 20 cm.

PER LA FATTIBILITÀ DELLE MISURE SPECIALI CONTATTARE IL SERVIZIO CLIENTI O CONSULTARE [HTTP://STORE.NOVELLINI.COM](http://store.novellini.com)

# ROSE ROSSE F SPECIAL 4

PARETE FISSA SPECIALE, PER INSTALLAZIONE SU MURETTO, SPECIALE IN LARGHEZZA ED ALTEZZA



6 mm



6 cm



## FINITURE VETRI



Trasparente  
cod 1

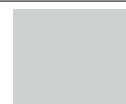

Satin  
cod 4

## FINITURE PROFILI



Bianco  
cod D



Silver  
cod B



Cromo  
cod K

Misure	Codice	Scelta vetro		Scelta profilo		
Misura effettiva d'ingombro		1	4	D	B	K
<b>F</b>		Trasparente	Satinato	Bianco	Silver	Cromo
H 25±200 L 30↔119,5	<b>ROSEF4SP</b>		+ 38 €	690 €	759 €	835 €

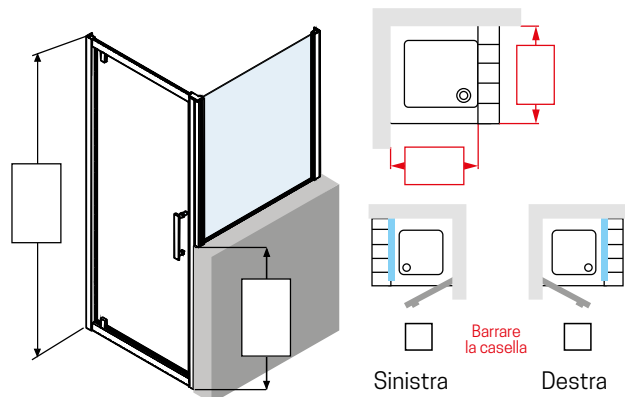
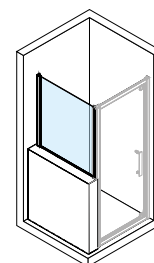

PER LA FATTIBILITÀ DELLE MISURE SPECIALI CONTATTARE IL SERVIZIO CLIENTI O CONSULTARE [HTTP://STORE.NOVELLINI.COM](http://store.novellini.com)

Costruzione del codice **Codice** + **Vetro** + **Profilo** = Codice prodotto finale

# ROSE ROSSE F SPECIAL 5



PARETE FISSA SPECIALE, IN LINEA / PARETE DIVISORIA / FISSAGGIO A MURO LATERALE / PROFILO CHIUSO



FISSAGGIO IN LINEA



FISSAGGIO A MURO LATERALE



PROFILO CHIUSO

## FISSAGGIO IN LINEA

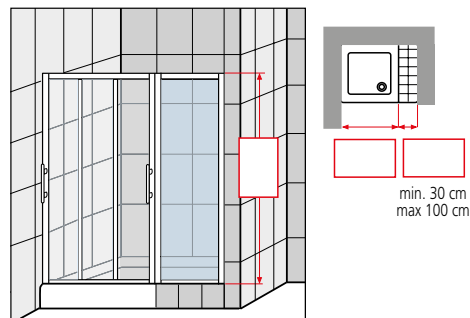

## FISSAGGIO A MURO LATERALE

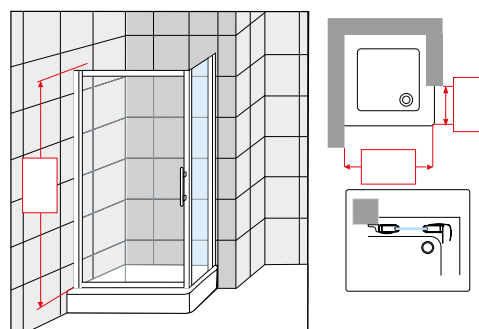

## PROFILO CHIUSO

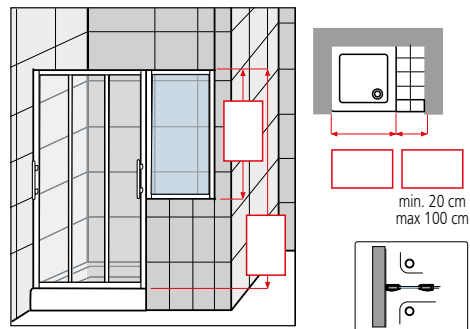

Misure	Codice	Scelta vetro		Scelta profilo		
		1	4	D	B	K
Misura effettiva d'ingombro						
<b>F</b>		Trasparente	Satinato	Bianco	Silver	Cromo
H 50↕200 L 20↔100	<b>ROSEF5SP</b>		+ 38 €	669 €	737 €	810 €

PER LA FATTIBILITÀ DELLE MISURE SPECIALI CONTATTARE IL SERVIZIO CLIENTI O CONSULTARE [HTTP://STORE.NOVELLINI.COM](http://store.novellini.com)



## DATI TECNICI

### FINITURE PROFILI



Bianco  
cod. D



Silver  
cod. B



Cromo  
cod. K



### VETRO TEMPRATO 6 mm (European Standards EN 14428)



Trasparente  
cod. 1



Satin  
cod. 4

### SERIGRAFIA

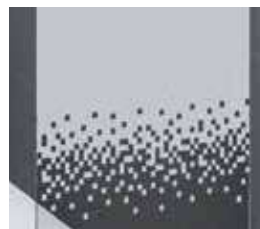

Rose 1  
cod. 56



Rose 2  
cod. 57

### MANIGLIA

### OPTIONAL



Maniglia in cristallo  
interasse 256 mm



Maniglia cromata



Maniglia cromata



Maniglia cromata



Maniglia cromata

Codice	Prezzo
<b>R40MACNF1-K</b>	72 €

Codice	Prezzo
<b>R40MAGIN1-K</b>	65 €

Codice	Prezzo
<b>R40EIMAGIN1-K</b>	113 €

Codice	Prezzo
<b>R40EIMACNF1-K</b>	119 €

Per altre maniglie consultare (pag. 644)

### MISURE DI INGOMBRO PROFILI DI FISSAGGIO

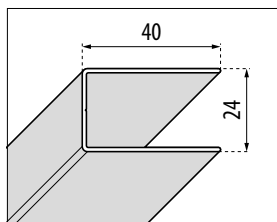

**A MURO**  
R - PH+F - A - 3PH

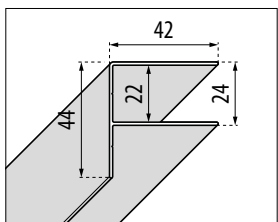

**A MURO**  
2A - B - 3P - G - S - 2M - 2P

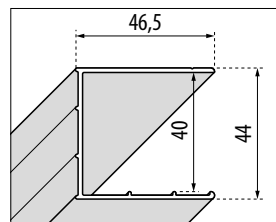

**A MURO**  
PHB

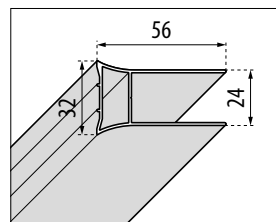

**COMPENSAZIONE**  
R - PH+F - A - 3PH

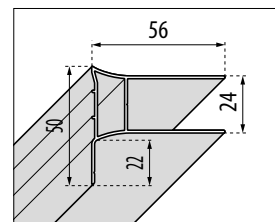

**COMPENSAZIONE**  
2A - B - 3P - G - S - 2M - 2P

Finitura	Codice
Bianco	<b>P01BEAST-A</b>
Silver	<b>P01BEAST-B</b>
Cromo	<b>P01BEAST-K</b>

Finitura	Codice
Bianco	<b>P01BEGST-A</b>
Silver	<b>P01BEGST-B</b>
Cromo	<b>P01BEGST-K</b>

Finitura	Codice
Bianco	<b>P01KUM01ST-A</b>
Silver	<b>P01KUM01ST-B</b>
Cromo	<b>P01KUM01ST-K</b>

Finitura	Codice
Bianco	<b>P05ROSST-A</b>
Silver	<b>P05ROSST-B</b>
Cromo	<b>P05ROSST-K</b>

Finitura	Codice
Bianco	<b>P05ROSCST-A</b>
Silver	<b>P05ROSCST-B</b>
Cromo	<b>P05ROSCST-K</b>

### COME RILEVARE LE MISURE

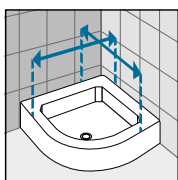
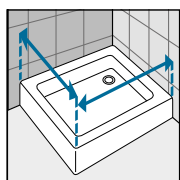

Rilevare le misure da muro a bordo esterno del piatto doccia. Le misure devono essere rilevate sulla parete finita, a rivestimenti posati, secondo gli schemi riportati.

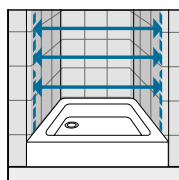

Rilevare le misure da muro a muro, in basso, in alto, al centro e utilizzare quella di valore inferiore. Le misure devono essere rilevate sulla parete finita, a rivestimenti posati, secondo gli schemi riportati.

# ZEPHYROS 2.0

INFINITE COMPOSIZIONI  
DI BENESSERE.



◀ Nuova maniglia



◀ Reversibile  
Scorrimenti montati  
(tranne per modelli PH / AH)



◀ Nuovo sistema di  
sganciamiento ante  
(per modelli PH / AH)



## TRATTAMENTI





# ZEPHYROS 2.0

# ZEPHYROS 2.0 2P



**PORTA DOCCIA APERTURA 1 ANTA SCORREVOLE E 1 FISSA IN LINEA**  
 ANTE SGANCIABILI PER UNA FACILE PULIZIA

Misure			Codice	Scelta vetro				Scelta profilo			
Misura effettiva d'ingombro	Fisso	Entrata (cm)		1	4	11	91	U	B	K	H
<b>A</b>	<b>F1</b>	<b>*</b>		Trasparente	Satin	Niva	Serigrafia Strip	Bianco opaco	Silver	Cromo	Nero opaco
96↔102	44	37	<b>ZEP22P96-</b>					702 €	790 €	878 €	878 €
114↔120	53	46	<b>ZEP22P114-</b>	●				785 €	873 €	960 €	960 €
116↔122	54	47	<b>ZEP22P116-</b>	●				785 €	873 €	960 €	960 €
126↔132	59	52	<b>ZEP22P126-</b>					840 €	929 €	1.017 €	1.017 €
136↔142	64	57	<b>ZEP22P136-</b>	●	+ 38 €	+ 38 €	+ 38 €	858 €	945 €	1.033 €	1.033 €
146↔152	69	62	<b>ZEP22P146-</b>	●				883 €	972 €	1.059 €	1.059 €
156↔162	74	67	<b>ZEP22P156-</b>	●				927 €	1.014 €	1.102 €	1.102 €
166↔172	79	72	<b>ZEP22P166-</b>	●				943 €	1.030 €	1.119 €	1.119 €
H 160↔200 L 96↔166	SPECIAL		<b>ZEP22PSP</b>		+ 38 €	+ 38 €	-	1.127 €	1.235 €	1.358 €	1.358 €

**POSSIBILITA' DI ORDINARE DUE PANNELLI FISSI LATERALI PER INSTALLAZIONE A CENTRO PARETE**

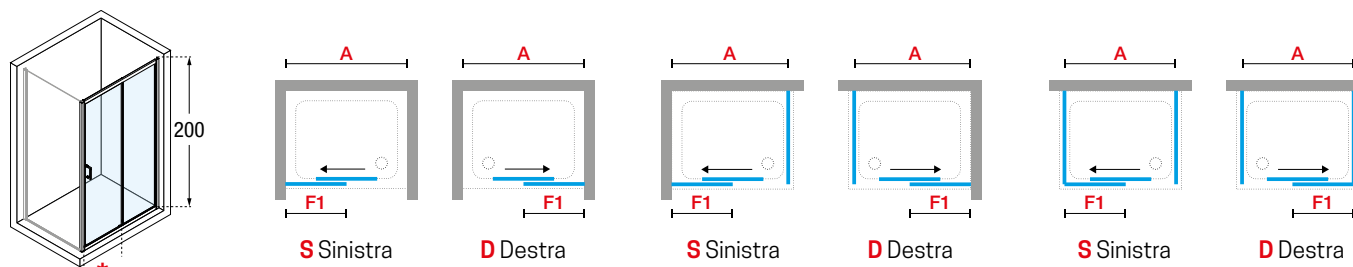



DISPOSITIVO DI  
SGANCIAMENTO ANTE  
MONTATO  
PORTA REVERSIBILE

**FINITURE VETRI**

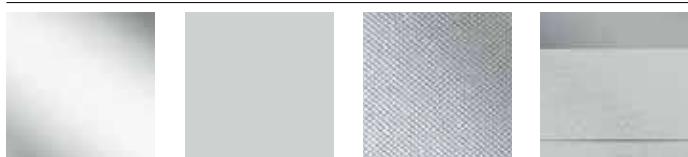

Trasparente  
**cod 1**

Satin  
**cod 4**

Niva  
**cod 11**

Strip  
**cod 91**

**FINITURE PROFILI**

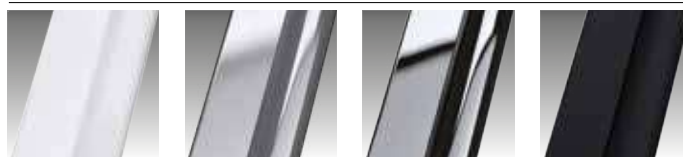

Bianco opaco  
**cod U**

Silver  
**cod B**

Cromo  
**cod K**

Nero opaco  
**cod H**

# ZEPHYROS 2.0 A



## BOX DOCCIA AD ANGOLO APERTURA 2 ANTE SCORREVOLI E 2 FISSE IN LINEA

ANTE SGANCIABILI PER UNA FACILE PULIZIA

Misure			Codice	Scelta vetro				Scelta profilo			
Misura effettiva d'ingombro	Fisso	Entrata (cm)		1	4	11	91	U	B	K	H
<b>A</b>	<b>F1</b>	*		Trasparente	Satin	Niva	Serigrafia Strip	Bianco opaco	Silver	Cromo	Nero opaco
67↔70	30	34	<b>ZEP2A67L-</b>	●				397 €	444 €	492 €	492 €
72↔75	33	37	<b>ZEP2A72L-</b>					397 €	444 €	492 €	492 €
74↔77	34	39	<b>ZEP2A74L-</b>					397 €	444 €	492 €	492 €
77↔80	35	41	<b>ZEP2A77L-</b>	●				424 €	472 €	519 €	519 €
82↔85	38	44	<b>ZEP2A82L-</b>					424 €	472 €	519 €	519 €
87↔90	40	48	<b>ZEP2A87L-</b>	●	+ 38 €	+ 38 €	+ 38 €	424 €	472 €	519 €	519 €
92↔95	43	51	<b>ZEP2A92L-</b>					467 €	513 €	560 €	560 €
97↔100	45	55	<b>ZEP2A97L-</b>	●				467 €	513 €	560 €	560 €
102↔105	48	59	<b>ZEP2A102L-</b>					477 €	524 €	572 €	572 €
107↔110	50	62	<b>ZEP2A107L-</b>					477 €	524 €	572 €	572 €
112↔115	53	66	<b>ZEP2A112L-</b>					488 €	535 €	583 €	583 €
117↔120	55	69	<b>ZEP2A117L-</b>	●				488 €	535 €	583 €	583 €

**PER COMPORRE UN ANGOLO ORDINARE 2 LATI.**

**POSSIBILITA' DI ORDINARE UN PANNELLO FISSO LATERALE PER INSTALLAZIONE A CENTRO PARETE**

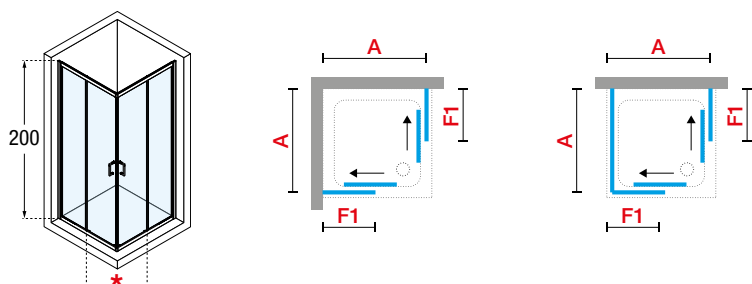



DISPOSITIVO DI  
SGANCIAMENTO ANTE  
MONTATO  
PORTA REVERSIBILE



#### FINITURE VETRI



Trasparente  
cod 1

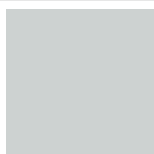

Satin  
cod 4



Niva  
cod 11



Strip  
cod 91

#### FINITURE PROFILI



Bianco opaco  
cod U

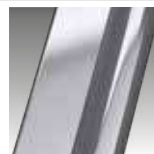

Silver  
cod B



Cromo  
cod K



Nero opaco  
cod H

# ZEPHYROS 2.0 PH+FH



**BOX DOCCIA, APERTURA 1 ANTA SCORREVOLE E 1 ANTA FISSA IN LINEA CON 1 PARETE FISSA LATERALE**

ANTE SGANCIABILI PER UNA FACILE PULIZIA

Misure			Codice	Destra	Sinistra	Scelta vetro				Scelta profilo			
Misura effettiva d'ingombro	Fisso	Entrata (cm)		D-	S-	1	4	11	91	U	B	K	H
<b>A</b>	<b>F1</b>	*				Trasparente	Satin	Niva	Serigrafia Strip	Bianco opaco	Silver	Cromo	Nero opaco

PORTA													
96↔99	48	39	<b>ZEP2PH96</b>	D-	S-	●				738 €	830 €	923 €	923 €
114↔117	57	48	<b>ZEP2PH114</b>	D-	S-	●				825 €	917 €	1.009 €	1.009 €
116↔119	58	49	<b>ZEP2PH116</b>	D-	S-	●				825 €	917 €	1.009 €	1.009 €
126↔129	63	54	<b>ZEP2PH126</b>	D-	S-	●				883 €	977 €	1.068 €	1.068 €
136↔139	68	59	<b>ZEP2PH136</b>	D-	S-	●	+ 38 €	+ 38 €	+ 38 €	902 €	993 €	1.085 €	1.085 €
146↔149	73	64	<b>ZEP2PH146</b>	D-	S-	●				928 €	1.020 €	1.113 €	1.113 €
156↔159	78	69	<b>ZEP2PH156</b>	D-	S-	●				974 €	1.065 €	1.158 €	1.158 €
166↔169	83	74	<b>ZEP2PH166</b>	D-	S-	●				990 €	1.083 €	1.175 €	1.175 €
H 160↕200 L 96↔166	SPECIAL		<b>ZEP2PHSP</b>				+ 38 €	+ 38 €	-	1.184 €	1.298 €	1.427 €	1.427 €

PARETE FISSA REVERSIBILE													
FH													
67↔70	-	-	<b>ZEP2FH67-</b>			●				340 €	370 €	399 €	399 €
73↔76	-	-	<b>ZEP2FH73-</b>			●				340 €	370 €	399 €	399 €
77↔80	-	-	<b>ZEP2FH77-</b>			●	+ 38 €	+ 38 €	+ 38 €	355 €	383 €	412 €	412 €
87↔90	-	-	<b>ZEP2FH87-</b>			●				370 €	399 €	427 €	427 €
97↔100	-	-	<b>ZEP2FH97-</b>							384 €	413 €	442 €	442 €
117↔120	-	-	<b>ZEP2FH117-</b>							384 €	413 €	442 €	442 €
H 160↕200 L 20↔117	SPECIAL		<b>ZEP2FHSP</b>				+ 38 €	+ 38 €	-	447 €	503 €	557 €	557 €

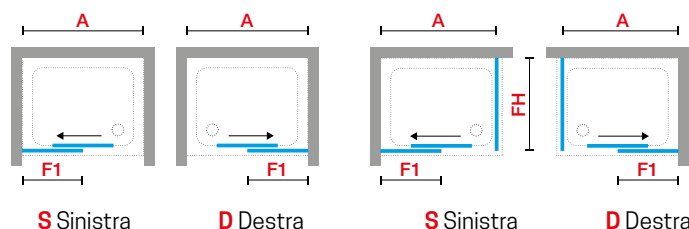
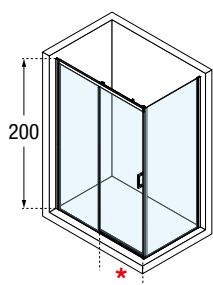





DISPOSITIVO DI  
SGANCIAMENTO ANTE  
MONTATO



**FINITURE VETRI**



Trasparente  
cod 1

Satin  
cod 4

Niva  
cod 11

Strip  
cod 91

**FINITURE PROFILI**

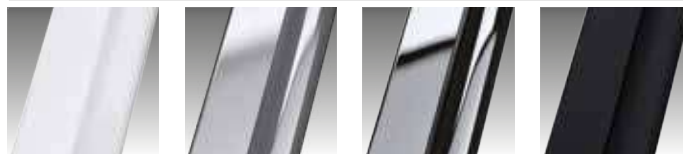

Bianco opaco  
cod U

Silver  
cod B

Cromo  
cod K

Nero opaco  
cod H

# ZEPHYROS 2.0 AH



**BOX DOCCIA AD ANGOLO APERTURA 2 ANTE SCORREVOLI E 2 FISSE**  
 ANTE SGANCIABILI PER UNA FACILE PULIZIA

Misure			Codice	Destra	Sinistra	Scelta vetro				Scelta profilo			
Misura effettiva d'ingombro	Fisso	Entrata (cm)				1	4	11	91	U	B	K	H
<b>A</b>	<b>F1</b>	*		D-	S-	Trasparente	Satin	Niva	Serigrafia Strip	Bianco opaco	Silver	Cromo	Nero opaco
67↔70	30	34	<b>ZEP2AH67L</b>	D-	S-	●				417 €	467 €	517 €	517 €
72↔75	33	37	<b>ZEP2AH72L</b>	D-	S-					417 €	467 €	517 €	517 €
74↔77	34	39	<b>ZEP2AH74L</b>	D-	S-					417 €	467 €	517 €	517 €
77↔80	35	41	<b>ZEP2AH77L</b>	D-	S-	●				445 €	495 €	545 €	545 €
82↔85	38	44	<b>ZEP2AH82L</b>	D-	S-					445 €	495 €	545 €	545 €
87↔90	40	48	<b>ZEP2AH87L</b>	D-	S-	●				445 €	495 €	545 €	545 €
92↔95	43	51	<b>ZEP2AH92L</b>	D-	S-		+ 38 €	+ 38 €	+ 38 €	490 €	539 €	589 €	589 €
97↔100	45	55	<b>ZEP2AH97L</b>	D-	S-	●				490 €	539 €	589 €	589 €
102↔105	48	59	<b>ZEP2AH102L</b>	D-	S-					502 €	550 €	600 €	600 €
107↔110	50	62	<b>ZEP2AH107L</b>	D-	S-	●				502 €	550 €	600 €	600 €
112↔115	53	66	<b>ZEP2AH112L</b>	D-	S-					513 €	563 €	613 €	613 €
117↔120	55	69	<b>ZEP2AH117L</b>	D-	S-	●				513 €	563 €	613 €	613 €

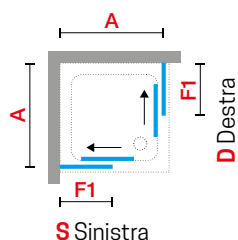
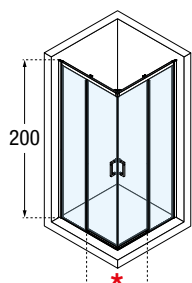

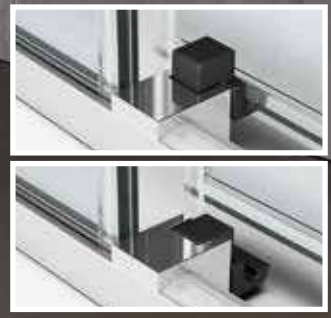

DISPOSITIVO DI SGANCIAMENTO ANTE MONTATO

FINITURE VETRI



Trasparente  
cod 1

Satin  
cod 4

Niva  
cod 11

Strip  
cod 91

FINITURE PROFILI

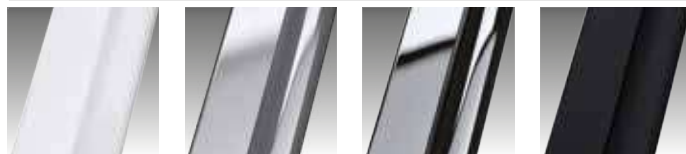

Bianco opaco  
cod U

Silver  
cod B

Cromo  
cod K

Nero opaco  
cod H

# ZEPHYROS 2.0 G



PORTA DOCCIA, APERTURA 1 ANTA BATTENTE

Misure			Codice	Scelta vetro					Scelta profilo			
Misura effettiva d'ingombro	Ingombro anta esterno	Entrata (cm)		1	4	11	91	82	U	B	K	H
<b>A</b>	<b>B</b>	<b>*</b>		Trasparente	Satin	Niva	Serigrafia Strip	Stripes	Bianco opaco	Silver	Cromo	Nero opaco
66↔72	54	54	<b>ZEP2G66-</b>						522 €	578 €	633 €	633 €
72↔78	60	60	<b>ZEP2G72-</b>						522 €	578 €	633 €	633 €
76↔82	64	64	<b>ZEP2G76-</b>		+ 38 €	+ 38 €	+ 38 €	+ 125 €	538 €	593 €	650 €	650 €
86↔92	74	74	<b>ZEP2G86-</b>						565 €	622 €	677 €	677 €
96↔102	84	84	<b>ZEP2G96-</b>						594 €	652 €	707 €	707 €
H 160↑200 L 66↔96	SPECIAL		<b>ZEP2GSP</b>	+ 38 €	+ 38 €	-	-		692 €	755 €	833 €	833 €

## ZEPHYROS 2.0 F STRIPES

Misure	Codice	Scelta vetro	Scelta profilo
Misura effettiva d'ingombro		<b>82</b>	<b>H</b>
<b>F</b>		Stripes	Nero opaco
66↔69	<b>ZEP2FN66-</b>	+ 125 €	379 €
68↔71	<b>ZEP2FN68-</b>		379 €
73↔76	<b>ZEP2FN73-</b>		379 €
76↔79	<b>ZEP2FN76-</b>		392 €
78↔81	<b>ZEP2FN78-</b>		392 €
83↔86	<b>ZEP2FN83-</b>		392 €
88↔91	<b>ZEP2FN88-</b>		405 €
93↔96	<b>ZEP2FN93-</b>		405 €
98↔101	<b>ZEP2FN98-</b>		420 €
118↔121	<b>ZEP2FN118-</b>		420 €

**LA SERIGRAFIA STRIPES VA ABBINATA SOLO CON PROFILO NERO OPACO PER I FISSI DI ALTRE FINITURE VEDI ZEPHYROS 2.0 F (PAG. 178)**

**POSSIBILITA' DI ORDINARE UN PANNELLO FISSO LATERALE PER INSTALLAZIONE A CENTRO PARETE**

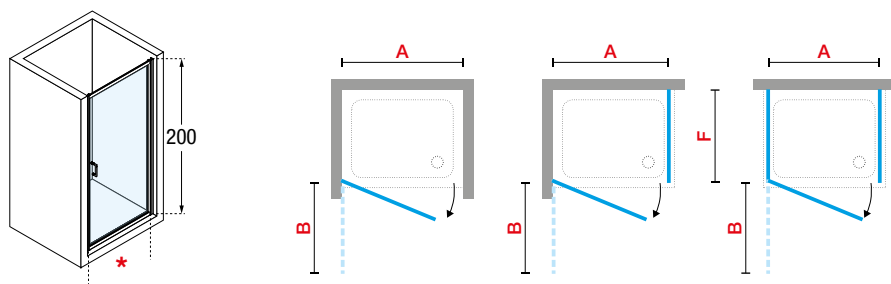



VERSIONE  
SERIGRAFIA STRIPES

FINITURE VETRI



Trasparente  
cod 1

Satin  
cod 4

Niva  
cod 11

Strip  
cod 91

Stripes  
cod 82

FINITURE PROFILI



Bianco opaco  
cod U

Silver  
cod B

Cromo  
cod K

Nero opaco  
cod H

# ZEPHYROS 2.0 2B

PORTA DOCCIA, APERTURA 2 ANTE BATTENTI



200 cm



6 mm



6 cm



## FINITURE VETRI

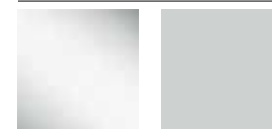

Trasparente  
cod 1

Satin  
cod 4



Niva  
cod 11

Strip  
cod 91

## FINITURE PROFILI



Bianco opaco  
cod U

Silver  
cod B



Cromo  
cod K

Nero opaco  
cod H

Misure			Codice	Scelta vetro				Scelta profilo			
Misura effettiva d'ingombro	Ingombro anta esterno	Entrata (cm)		1	4	11	91	U	B	K	H
<b>A</b>	<b>B</b>	<b>*</b>		Trasparente	Satin	Niva	Serigrafia Strip	Bianco opaco	Silver	Cromo	Nero opaco
66↔72	26	55	<b>ZEP22B66-</b>					617 €	685 €	757 €	757 €
72↔78	29	61	<b>ZEP22B72-</b>					644 €	715 €	787 €	787 €
76↔82	31	65	<b>ZEP22B76-</b>	+ 38 €	+ 38 €			673 €	744 €	814 €	814 €
86↔92	36	75	<b>ZEP22B86-</b>					703 €	773 €	844 €	844 €
96↔102	41	85	<b>ZEP22B96-</b>					732 €	800 €	872 €	872 €

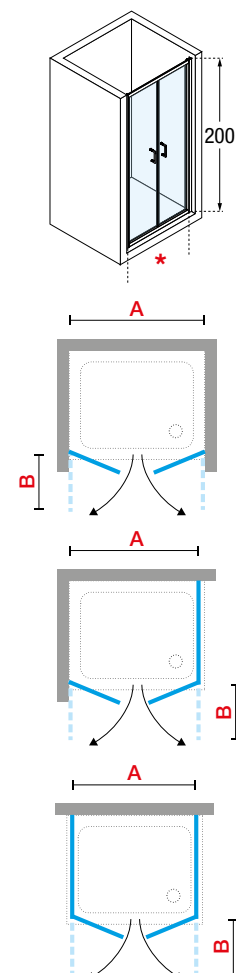

**POSSIBILITA' DI ORDINARE UN PANNELLO FISSO LATERALE PER INSTALLAZIONE A CENTRO PARETE**

# ZEPHYROS 2.0 S

PORTA DOCCIA, APERTURA 2 ANTE A SOFFIETTO



200 cm



6 mm



6 cm



CERNIERE AVVITATE

## FINITURE VETRI



Trasparente  
cod 1

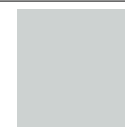

Satin  
cod 4



Niva  
cod 11



Strip  
cod 91

## FINITURE PROFILI



Bianco opaco  
cod U



Silver  
cod B



Cromo  
cod K



Nero opaco  
cod H

Misure			Codice	Scelta vetro				Scelta profilo			
Misura effettiva d'ingombro	Ingombro anta	Entrata (cm)		1	4	11	91	U	B	K	H
<b>A</b>	<b>B</b>	*		Trasparente	Satinato	Niva	Serigrafia Strip	Bianco opaco	Silver	Cromo	Nero opaco
66↔72	31	46	<b>ZEP2S66-</b>					697 €	773 €	850 €	850 €
72↔78	34	52	<b>ZEP2S72-</b>					709 €	787 €	864 €	864 €
76↔82	36	56	<b>ZEP2S76-</b>	●	+ 38 €	+ 38 €	+ 38 €	739 €	815 €	893 €	893 €
86↔92	41	66	<b>ZEP2S86-</b>	●				752 €	829 €	907 €	907 €
96↔102	46	76	<b>ZEP2S96-</b>	●				782 €	858 €	935 €	935 €

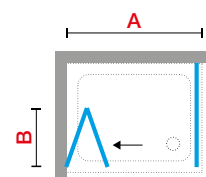
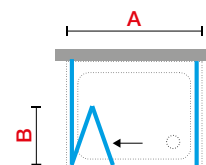
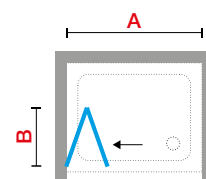
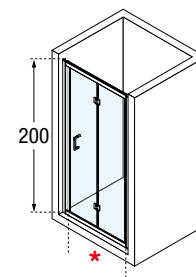

**POSSIBILITA' DI ORDINARE UN PANNELLO FISSO LATERALE PER INSTALLAZIONE A CENTRO PARETE**

Costruzione del codice **Codice** + **Vetro** + **Profilo** = Codice prodotto finale



# ZEPHYROS 2.0 S IN OUT

PORTA DOCCIA, 2 ANTE A SOFFIETTO CON APERTURA DI SICUREZZA



200 cm



6 mm



6 cm



## FINITURE VETRI

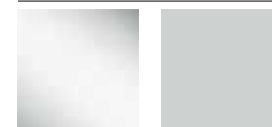

Trasparente  
cod 1

Satin  
cod 4



Niva  
cod 11

Strip  
cod 91

## FINITURE PROFILI



Bianco opaco  
cod U

Silver  
cod B



Cromo  
cod K

Nero opaco  
cod H

Misure			Codice	Scelta vetro				Scelta profilo			
Misura effettiva d'ingombro	Ingombro anta	Entrata (cm)		1	4	11	91	U	B	K	H
A	B	*		Trasparente	Satin	Niva	Serigrafia Strip	Bianco opaco	Silver	Cromo	Nero opaco
66↔72	31	46	<b>ZEP2S266-</b>					738 €	818 €	897 €	897 €
72↔78	34	52	<b>ZEP2S272-</b>					750 €	830 €	910 €	910 €
76↔82	36	56	<b>ZEP2S276-</b>	●	+ 38 €	+ 38 €	+ 38 €	778 €	857 €	937 €	937 €
86↔92	41	66	<b>ZEP2S286-</b>	●				792 €	872 €	952 €	952 €
96↔102	46	76	<b>ZEP2S296-</b>	●				825 €	905 €	984 €	984 €

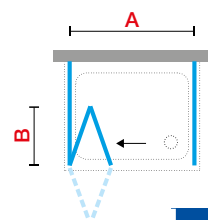
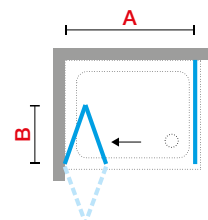
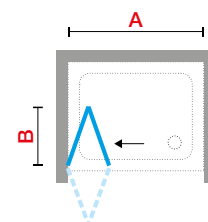
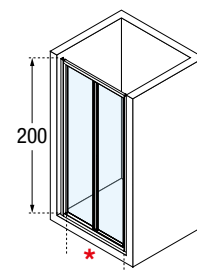

**POSSIBILITA' DI ORDINARE UN PANNELLO FISSO LATERALE PER INSTALLAZIONE A CENTRO PARETE**



**APERTURA DI SICUREZZA.**

**ATTENZIONE: L'APERTURA VERSO L'ESTERNO DEVE ESSERE CONSIDERATA SOLAMENTE COME APERTURA D'EMERGENZA**





# ZEPHYROS 2.0 3P



200 cm



6 mm



6 cm



PORTA DOCCIA APERTURA 3 ANTE SCORREVOLI BILATERALE DA DESTRA E DA SINISTRA



## FINITURE VETRI



Trasparente  
cod 1

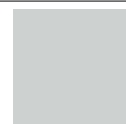

Satin  
cod 4



Niva  
cod 11



Strip  
cod 91

## FINITURE PROFILI



Bianco opaco  
cod U



Silver  
cod B



Cromo  
cod K



Nero opaco  
cod H

Misure		Codice	Scelta vetro				Scelta profilo			
Misura effettiva d'ingombro	Entrata (cm)		1	4	11	91	U	B	K	H
<b>A</b>	*		Trasparente	Satin	Niva	Serigrafia Strip	Bianco opaco	Silver	Cromo	Nero opaco
96↔102	41	<b>ZEP23P96-</b>					782 €	862 €	940 €	940 €
106↔112	48	<b>ZEP23P106-</b>					795 €	875 €	957 €	957 €
116↔122	54	<b>ZEP23P116-</b>		+ 38 €	+ 38 €	+ 38 €	824 €	904 €	983 €	983 €
126↔132	61	<b>ZEP23P126-</b>					853 €	933 €	1.013 €	1.013 €
136↔142	68	<b>ZEP23P136-</b>					884 €	964 €	1.044 €	1.044 €

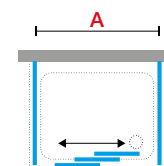
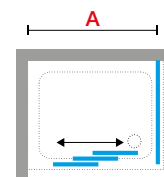
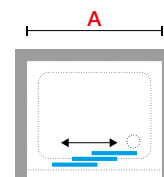
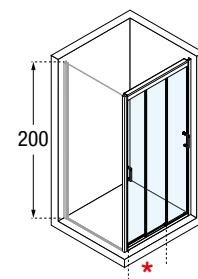

**POSSIBILITA' DI ORDINARE UN PANNELLO FISSO LATERALE PER INSTALLAZIONE A CENTRO PARETE**

Costruzione del codice **Codice** + **Vetro** + **Profilo** = Codice prodotto finale

# ZEPHYROS 2.0 2A

PORTA DOCCIA APERTURA 2 ANTE SCORREVOLI E 2 FISSE IN LINEA



200 cm



6 mm



6 cm



DISPOSITIVO DI SGANCIAMENTO ANTE MONTATO  
PORTA REVERSIBILE

## FINITURE VETRI

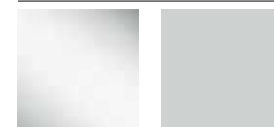

Trasparente  
cod 1

Satin  
cod 4



Niva  
cod 11

Strip  
cod 91

## FINITURE PROFILI



Bianco opaco  
cod U

Silver  
cod B



Cromo  
cod K

Nero opaco  
cod H

Misure			Codice	Scelta vetro				Scelta profilo			
Misura effettiva d'ingombro	Fisso	Entrata (cm)		1	4	11	91	U	B	K	H
<b>A</b>	<b>F1</b>	*		Trasparente	Satin	Niva	Serigrafia Strip	Bianco opaco	Silver	Cromo	Nero opaco
146↔152	35	54	<b>ZEP22A146-</b>					1.040 €	1.147 €	1.253 €	1.253 €
156↔162	38	59	<b>ZEP22A156-</b>					1.053 €	1.159 €	1.267 €	1.267 €
166↔172	40	64	<b>ZEP22A166-</b>					1.069 €	1.175 €	1.282 €	1.282 €
176↔182	43	69	<b>ZEP22A176-</b>		+ 38 €	+ 38 €	+ 38 €	1.084 €	1.190 €	1.298 €	1.298 €
186↔192	48	69	<b>ZEP22A186-</b>					1.098 €	1.205 €	1.312 €	1.312 €
196↔202	53	69	<b>ZEP22A196-</b>					1.114 €	1.222 €	1.327 €	1.327 €

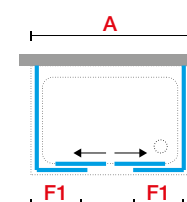
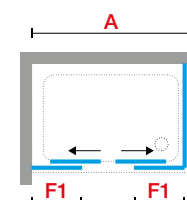
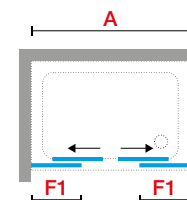
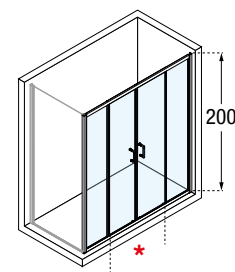

POSSIBILITA' DI ORDINARE UN PANNELLO FISSO LATERALE PER INSTALLAZIONE A CENTRO PARETE

# ZEPHYROS 2.0 R



200 cm



6 mm



3 cm



BOX DOCCIA AD ANGOLO SEMICIRCOLARE, APERTURA 2 ANTE SCORREVOLI E 2 FISSE



DISPOSITIVO DI SGANCIAMENTO ANTE MONTATO  
PORTA REVERSIBILE

## FINITURE VETRI

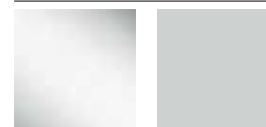

Trasparente  
cod 1

Satin  
cod 4



Niva  
cod 11

Strip  
cod 91

## FINITURE PROFILI



Bianco opaco  
cod U

Silver  
cod B



Cromo  
cod K

Nero opaco  
cod H

Misure			Codice	Scelta vetro				Scelta profilo			
Misura effettiva d'ingombro	Fisso	Entrata (cm)		1	4	11	91	U	B	K	H
<b>A</b>	<b>F1</b>	*		Trasparente	Satin	Niva	Serigrafia Strip	Bianco opaco	Silver	Cromo	Nero opaco
77,5↔80,5	24	42	<b>ZEP2R80-</b>					1.169 €	1.298 €	1.425 €	1.425 €
87,5↔90,5	34	52	<b>ZEP2R90-</b>	+ 76 €	+ 76 €	+ 76 €		1.240 €	1.368 €	1.497 €	1.497 €
97,5↔100,5	44	52	<b>ZEP2R100-</b>					1.312 €	1.439 €	1.568 €	1.568 €

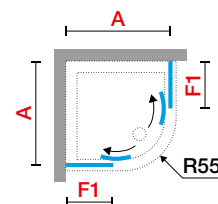
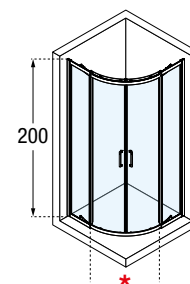

# ZEPHYROS 2.0 F

PARETE FISSA LATERALE



200 cm



6 mm



3 cm



## FINITURE VETRI



Trasparente  
cod 1

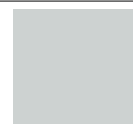

Satin  
cod 4



Niva  
cod 11



Strip  
cod 91

## FINITURE PROFILI



Bianco opaco  
cod U

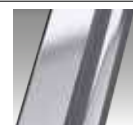

Silver  
cod B



Cromo  
cod K



Nero opaco  
cod H

Misure	Codice	Scelta vetro				Scelta profilo			
		1	4	11	91	U	B	K	H
Misura effettiva d'ingombro		Trasparente	Satin	Niva	Serigrafia Strip	Bianco opaco	Silver	Cromo	Nero opaco
<b>F</b>									
66↔69	<b>ZEP2F66-</b>					324 €	352 €	379 €	379 €
68↔71	<b>ZEP2F68-</b>	●				324 €	352 €	379 €	379 €
73↔76	<b>ZEP2F73-</b>	●				324 €	352 €	379 €	379 €
76↔79	<b>ZEP2F76-</b>	●				338 €	364 €	392 €	392 €
78↔81	<b>ZEP2F78-</b>	●				338 €	364 €	392 €	392 €
83↔86	<b>ZEP2F83-</b>		+ 38 €	+ 38 €	+ 38 €	338 €	364 €	392 €	392 €
88↔91	<b>ZEP2F88-</b>	●				352 €	379 €	405 €	405 €
93↔96	<b>ZEP2F93-</b>					352 €	379 €	405 €	405 €
98↔101	<b>ZEP2F98-</b>					365 €	393 €	420 €	420 €
118↔121	<b>ZEP2F118-</b>					365 €	393 €	420 €	420 €

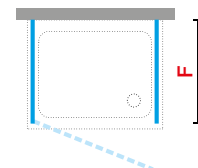
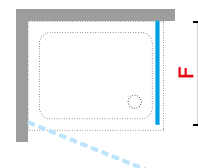
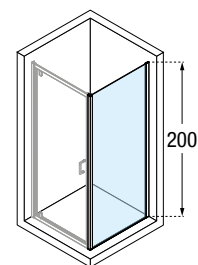

**PER LE SOLUZIONI CON DUE PANNELLI FISSI LATERALI  
UTILIZZARE SEMPRE 2 BARRE DI SOSTEGNO AD ANGOLO.**



# ZEPHYROS 2.0 F SPECIAL 1

PARETE FISSA SPECIALE, SPECIALE IN LARGHEZZA



## FINITURE VETRI



Trasparente  
cod 1

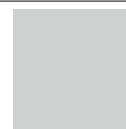

Satin  
cod 4



Niva  
cod 11

## FINITURE PROFILI



Bianco opaco  
cod U



Silver  
cod B



Cromo  
cod K



Nero opaco  
cod H

Misure	Codice	Scelta vetro			Scelta profilo			
		1	4	11	U	B	K	H
Misura effettiva d'ingombro		Trasparente	Satin	Niva	Bianco opaco	Silver	Cromo	Nero opaco
<b>A</b>								
H 150↓200 L 20↔118	<b>ZEP2F1SP</b>	+ 38 €	+ 38 €	425 €	478 €	529 €	529 €	

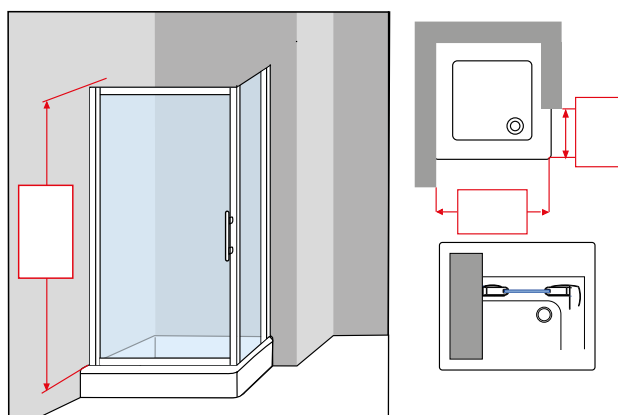
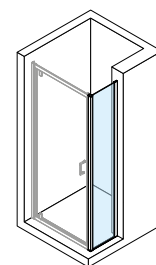

PER ALTRE CONFIGURAZIONI O FATTIBILITA' DELLE MISURE CONTATTARE IL SERVIZIO CLIENTI O CONSULTARE [HTTP://STORE.NOVELLINI.COM](http://store.novellini.com)

Costruzione del codice **Codice** + **Vetro** + **Profilo** = Codice prodotto finale

# ZEPHYROS 2.0 F SPECIAL 2

PARETE FISSA SPECIALE, SAGOMATA 5 LATI



6 mm



3 cm



## FINITURE VETRI



Trasparente  
cod 1



Satin  
cod 4



Niva  
cod 11

## FINITURE PROFILI



Bianco opaco  
cod U



Silver  
cod B



Cromo  
cod K



Nero opaco  
cod H

Misure	Codice	Scelta vetro			Scelta profilo			
		1	4	11	U	B	K	H
Misura effettiva d'ingombro		Trasparente	Satin	Niva	Bianco opaco	Silver	Cromo	Nero opaco
<b>A</b>								
H 155±200 L 60↔119	<b>ZEP2F2SP</b>	+ 38 €	+ 38 €		638 €	703 €	767 €	767 €

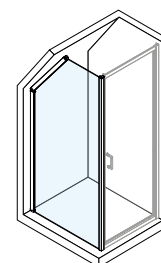

Sinistra

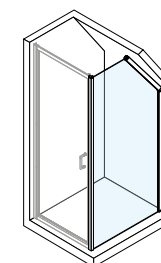

Destra

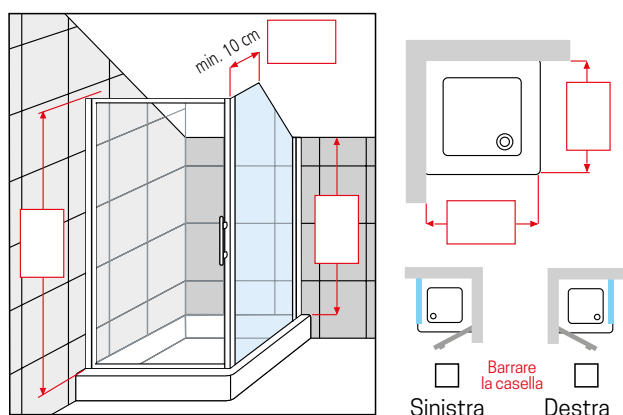

PER ALTRE CONFIGURAZIONI O FATTIBILITÀ DELLE MISURE CONTATTARE IL SERVIZIO CLIENTI O CONSULTARE [HTTP://STORE.NOVELLINI.COM](http://store.novellini.com)



# ZEPHYROS 2.0 F SPECIAL 3

PARETE FISSA SPECIALE, SAGOMATA 6 LATI



6 mm



3 cm



## FINITURE VETRI



Trasparente  
cod 1



Satin  
cod 4



Niva  
cod 11

## FINITURE PROFILI



Bianco opaco  
cod U



Silver  
cod B



Cromo  
cod K



Nero opaco  
cod H

Misure	Codice	Scelta vetro			Scelta profilo			
		1	4	11	U	B	K	H
Misura effettiva d'ingombro		Trasparente	Satin	Niva	Bianco opaco	Silver	Cromo	Nero opaco
<b>A</b>								
H 140↕200 L 60↔99	<b>ZEP2F3SP</b>	+ 38 €	+ 38 €	718 €	795 €	873 €	873 €	

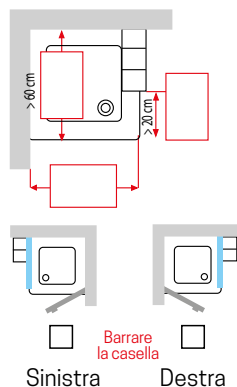
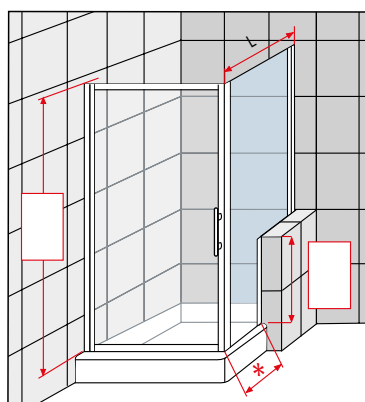
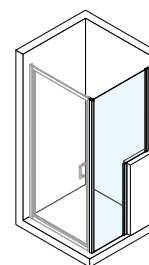

\*  $\geq L/3$ : LA QUOTA DI \* DEVE ESSERE MAGGIORE DI 1/3 DELLA LUCE SUPERIORE E COMUNQUE NON INFERIORE A 20 cm.

PER ALTRE CONFIGURAZIONI O FATTIBILITÀ DELLE MISURE CONTATTARE IL SERVIZIO CLIENTI O CONSULTARE [HTTP://STORE.NOVELLINI.COM](http://store.novellini.com)

Costruzione del codice **Codice** + **Vetro** + **Profilo** = Codice prodotto finale

# ZEPHYROS 2.0 F SPECIAL 4

PARETE FISSA SPECIALE, PER INSTALLAZIONE SU MURETTO, SPECIALE IN LARGHEZZA ED ALTEZZA



6 mm



6 cm



## FINITURE VETRI

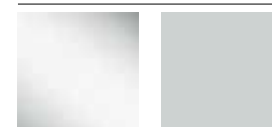

Trasparente  
cod 1

Satin  
cod 4



Niva  
cod 11

## FINITURE PROFILI



Bianco opaco  
cod U

Silver  
cod B



Cromo  
cod K

Nero opaco  
cod H

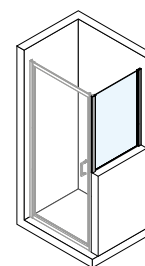

Misure	Codice	Scelta vetro			Scelta profilo			
		1	4	11	U	B	K	H
Misura effettiva d'ingombro		Trasparente	Satin	Niva	Bianco opaco	Silver	Cromo	Nero opaco
<b>A</b>								
H 25↕200 L 20↔118	<b>ZEP2F4SP</b>	+ 38 €	+ 38 €	453 €	504 €	555 €	555 €	

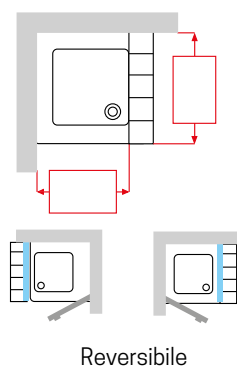
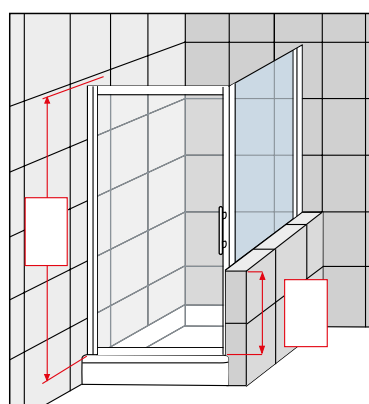

PER ALTRE CONFIGURAZIONI O FATTIBILITÀ DELLE MISURE CONTATTARE IL SERVIZIO CLIENTI O CONSULTARE [HTTP://STORE.NOVELLINI.COM](http://store.novellini.com)





# ZEPHYROS 2.0 F SPECIAL 5



6 mm



3 cm



PARETE FISSA SPECIALE, IN LINEA / PARETE DIVISORIA / FISSAGGIO A MURO LATERALE / PROFILO CHIUSO



FISSAGGIO IN LINEA



PARETE DIVISORIA



FISSAGGIO A MURO LATERALE



PROFILO CHIUSO

## FISSAGGIO IN LINEA

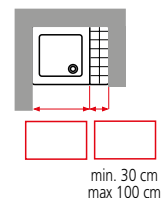
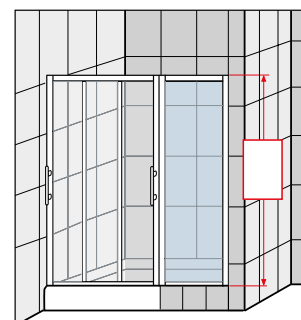

## PARETE DIVISORIA

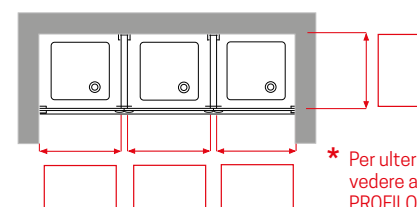
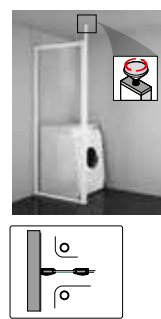
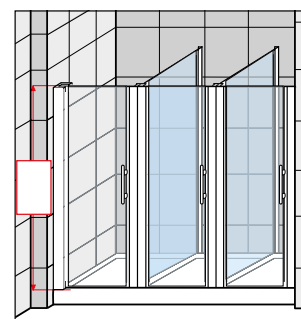

\* Per ulteriori informazioni vedere a pag. 184  
PROFILO A SOFFITTO

## FISSAGGIO A MURO LATERALE

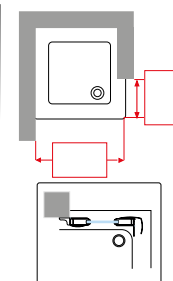
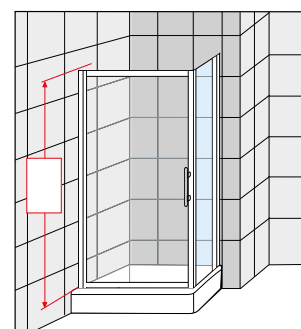

## PROFILO CHIUSO

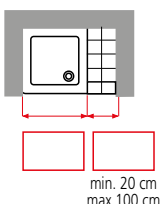
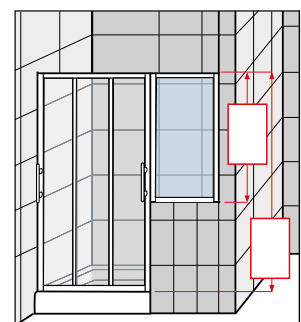

Misure	Codice	Scelta vetro			Scelta profilo			
		1	4	11	U	B	K	H
Misura effettiva d'ingombro								
<b>A</b>		Trasparente	Satin	Niva	Bianco opaco	Silver	Cromo	Nero opaco

### FISSI IN LINEA E PROFILI CHIUSI

H 25↔60	<b>ZEP2F5SP</b>				453 €	524 €	594 €	594 €
H 60↔96	<b>ZEP2F5SP</b>				505 €	577 €	648 €	648 €
H 96↔160	<b>ZEP2F5SP</b>	+ 38 €	+ 38 €		545 €	617 €	687 €	687 €
H 160↔190	<b>ZEP2F5SP</b>				579 €	650 €	720 €	720 €
H 190↔200	<b>ZEP2F5SP</b>				612 €	682 €	753 €	753 €

### PARETE DIVISORIA

H 25↔60	<b>ZEP2F5SP</b>				485 €	555 €	627 €	627 €
H 60↔96	<b>ZEP2F5SP</b>				545 €	617 €	687 €	687 €
H 96↔160	<b>ZEP2F5SP</b>	+ 38 €	+ 38 €		579 €	650 €	720 €	720 €
H 160↔190	<b>ZEP2F5SP</b>				612 €	682 €	753 €	753 €
H 190↔200	<b>ZEP2F5SP</b>				652 €	722 €	793 €	793 €

### FISSAGGIO LATERALE

H 25↔60	<b>ZEP2F5SP</b>				519 €	589 €	660 €	660 €
H 60↔96	<b>ZEP2F5SP</b>				579 €	650 €	720 €	720 €
H 96↔160	<b>ZEP2F5SP</b>	+ 38 €	+ 38 €		612 €	682 €	753 €	753 €
H 160↔190	<b>ZEP2F5SP</b>				652 €	722 €	793 €	793 €
H 190↔200	<b>ZEP2F5SP</b>				692 €	762 €	833 €	833 €

PER ALTRE CONFIGURAZIONI O FATTIBILITA' DELLE MISURE CONTATTARE IL SERVIZIO CLIENTI O CONSULTARE [HTTP://STORE.NOVELLINI.COM](http://store.novellini.com)

Costruzione del codice    **Codice** + **Vetro** + **Profilo** = Codice prodotto finale

## DATI TECNICI

### FINITURE PROFILI

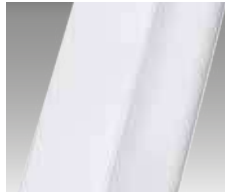

Bianco opaco  
cod. U



Silver  
cod. B



Cromo  
cod. K

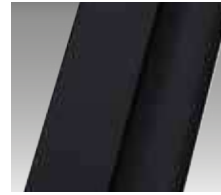

Nero opaco  
cod. H

### MANIGLIA



Maniglia

### VETRO TEMPRATO 6 mm (European Standards EN 14428)



Trasparente  
cod. 1



Satin  
cod. 4

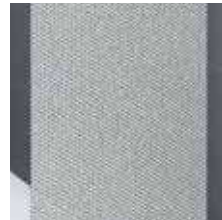

Niva  
cod. 11

### SERIGRAFIA



Strip  
cod. 91



Stripes  
cod. 82  
solo per modelli G - F

### OPTIONAL



#### BARRA DI SOSTEGNO AD ANGOLO

Finitura	Misure	Codice	Prezzo
Bianco opaco	25 cm	<b>R80LOU250-U</b>	72 €
Cromo		<b>R80LOU250-K</b>	72 €
Nero opaco	35 cm	<b>R80LOU250-H</b>	72 €
Bianco opaco		<b>R80LOU350-U</b>	78 €
Cromo	<b>R80LOU350-K</b>	78 €	
Nero opaco	45 cm	<b>R80LOU350-H</b>	78 €
Bianco opaco		<b>R80LOU450-U</b>	85 €
Cromo	<b>R80LOU450-K</b>	85 €	
Nero opaco	<b>R80LOU450-H</b>	85 €	

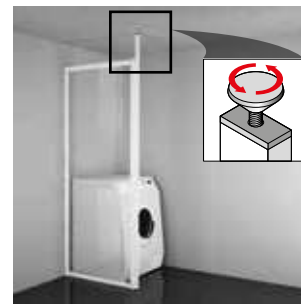

#### PROFILO A SOFFITTO

▪ Profilo speciale per fissaggio a soffitto da abbinare allo ZEP2F5SP

Finitura	Misure	Codice	Prezzo
Bianco	H 180 ↓ 265	<b>SPA3102</b>	115 €
Silver	H 180 ↓ 265	<b>SPA3102</b>	128 €
Cromo	H 240	<b>SPA31240ST-K</b>	142 €

### MISURE DI INGOMBRO PROFILI DI FISSAGGIO

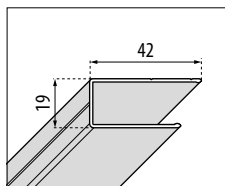

**A MURO**  
A - R - F - AH - PH - FH

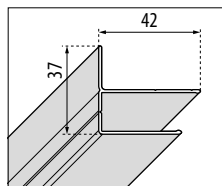

**A MURO**  
2P - G - B - S2 - 3P - 2A

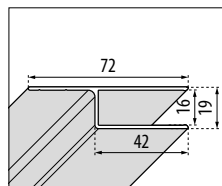

**A MURO**  
fissaggio a muro laterale  
tutti i modelli

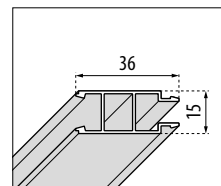

**COMPENSATIVI**  
tutti i modelli

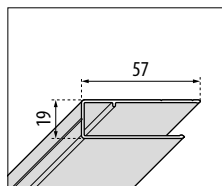

**COMPENSATIVI**  
A - R - F - AH - PH - FH

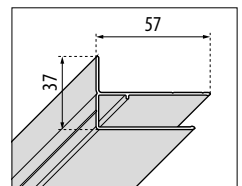

**COMPENSATIVI**  
2P - G - B - S2 - 3P - 2A

Finitura	Codice
Bianco	<b>P01BHRAST2-U</b>
Silver	<b>P01BHRAST2-B</b>
Cromo	<b>P01BHRAST2-K</b>
Nero	<b>P01BHRAST2-H</b>

Finitura	Codice
Bianco	<b>P01BHMOST2-U</b>
Silver	<b>P01BHMOST2-B</b>
Cromo	<b>P01BHMOST2-K</b>
Nero	<b>P01BHMOST2-H</b>

Finitura	Codice
Bianco	<b>P01L215STL2-U</b>
Silver	<b>P01L215STL2-B</b>
Cromo	<b>P01L215STL2-K</b>
Nero	<b>P01L215STL2-H</b>

Finitura	Codice
Bianco	<b>P05HAAST2-U</b>
Silver	<b>P05HAAST2-B</b>
Cromo	<b>P05HAAST2-K</b>
Nero	<b>P05HAAST2-H</b>

Finitura	Codice
Bianco	<b>P05BHST2-U</b>
Silver	<b>P05BHST2-B</b>
Cromo	<b>P05BHST2-K</b>
Nero	<b>P05BHST2-H</b>

Finitura	Codice
Bianco	<b>P05BHCST2-U</b>
Silver	<b>P05BHCST2-B</b>
Cromo	<b>P05BHCST2-K</b>
Nero	<b>P05BHCST2-H</b>

### COME RILEVARE LE MISURE

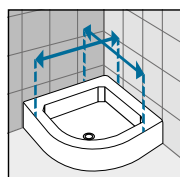
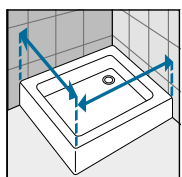

Rilevare le misure da muro a bordo esterno del piatto doccia. Le misure devono essere rilevate sulla parete finita, a rivestimenti posati, secondo gli schemi riportati.

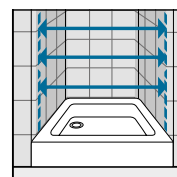

Rilevare le misure da muro a muro, in basso, in alto, al centro e utilizzare quella di valore inferiore. Le misure devono essere rilevate sulla parete finita, a rivestimenti posati, secondo gli schemi riportati.



# LUNES

IMMAGINA QUANTE  
PIÙ COMBINAZIONI PUOI.  
AGGIUNGINE ANCORA.



◀  
Maniglia



◀  
Sistema di scorrimento  
silenzioso su cuscinetti a  
sfera



◀  
Sistema di sganciamento  
anta per una facile pulizia

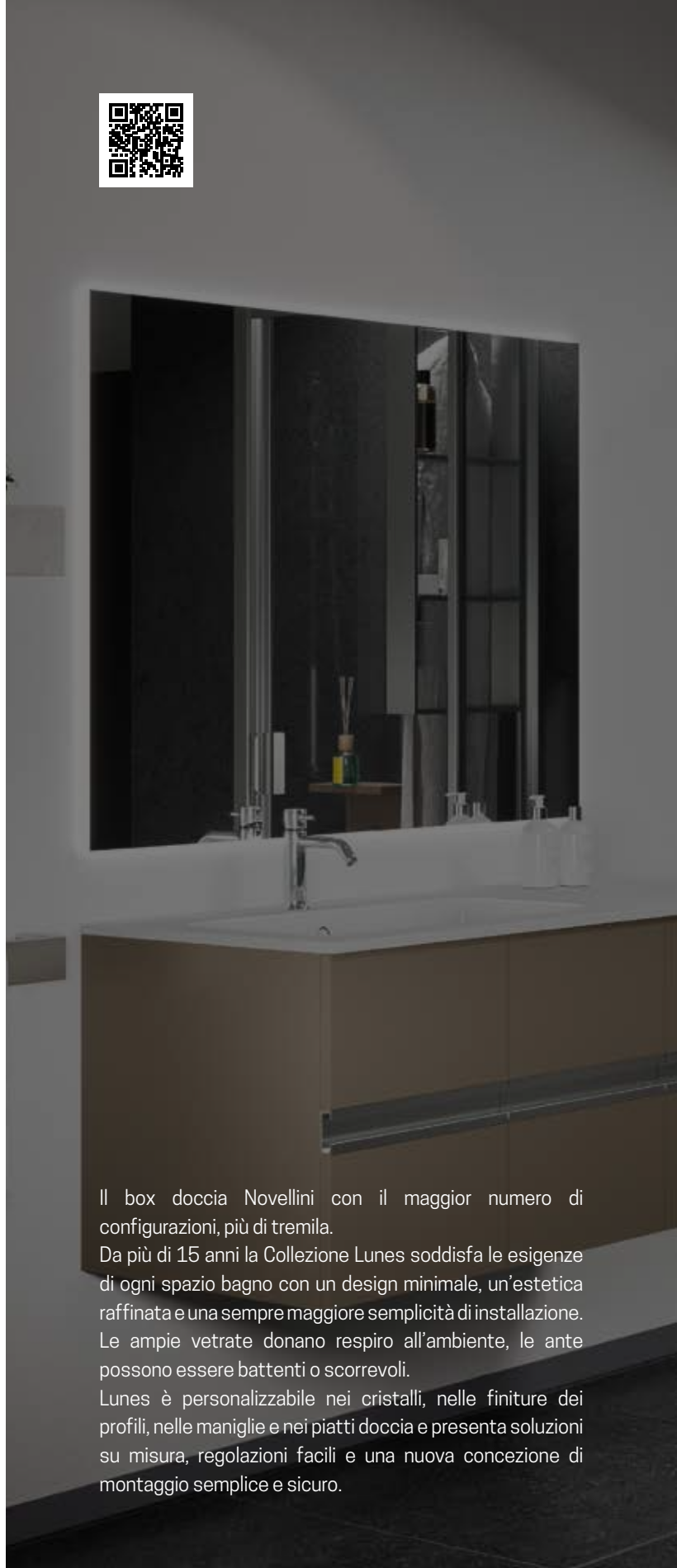

Il box doccia Novellini con il maggior numero di configurazioni, più di tremila.

Da più di 15 anni la Collezione Lunes soddisfa le esigenze di ogni spazio bagno con un design minimale, un'estetica raffinata e una sempre maggiore semplicità di installazione. Le ampie vetrate donano respiro all'ambiente, le ante possono essere battenti o scorrevoli.

Lunes è personalizzabile nei cristalli, nelle finiture dei profili, nelle maniglie e nei piatti doccia e presenta soluzioni su misura, regolazioni facili e una nuova concezione di montaggio semplice e sicuro.

## TRATTAMENTI





# LUNES

## BOX DOCCIA AD ANGOLO APERTURA 2 ANTE SCORREVOLI E 2 FISSE IN LINEA

Misure				Codice	Scelta vetro				Scelta profilo			
Misura effettiva d'ingombro	Fisso		Entrata (cm)		1	2	11	78	A	B	K	J
A	F1	F2	*		Traspa- rente	Aqua	Niva	Serigrafia lunes 2.0	Bianco	Silver	Cromo	Argento
<b>LATO</b>												
66↔69	33	-	36	<b>LUNA66L-</b>					323 €	366 €	402 €	351 €
69↔72	34,5	-	38	<b>LUNA69L-</b>					323 €	366 €	402 €	351 €
72↔75	36	-	40	<b>LUNA72L-</b>					323 €	366 €	402 €	351 €
75↔78	37,5	-	42	<b>LUNA75L-</b>					323 €	366 €	402 €	351 €
78↔81	39	-	44	<b>LUNA78L-</b>					340 €	383 €	423 €	369 €
81↔84	40,5	-	46	<b>LUNA81L-</b>					340 €	383 €	423 €	369 €
84↔87	42	-	48	<b>LUNA84L-</b>					340 €	383 €	423 €	369 €
87↔90	43,5	-	50	<b>LUNA87L-</b>					340 €	383 €	423 €	369 €
90↔93	45	-	53	<b>LUNA90L-</b>		+ 38 €	+ 38 €	+ 38 €	377 €	420 €	462 €	404 €
93↔96	46,5	-	55	<b>LUNA93L-</b>					377 €	420 €	462 €	404 €
96↔99	48	-	57	<b>LUNA96L-</b>					377 €	420 €	462 €	404 €
99↔102	49,5	-	59	<b>LUNA99L-</b>					377 €	420 €	462 €	404 €
108↔111	54	-	65	<b>LUNA108L-</b>					413 €	456 €	503 €	438 €
111↔114	55,5	-	67	<b>LUNA111L-</b>					413 €	456 €	503 €	438 €
114↔117	57	-	69	<b>LUNA114L-</b>					451 €	494 €	544 €	473 €
117↔120	58,5	-	71	<b>LUNA117L-</b>					451 €	494 €	544 €	473 €
H 160↔200 L 63↔117	SPECIAL			<b>LUNALSP</b>		+ 38 €	+ 38 €	-	597 €	661 €	727 €	634 €

### NOVITA' 2023

#### ANGOLO COMPLETO MONTATO

66↔69 x 66↔69	33	33	36	<b>LUNA66M-</b>	●				600 €	680 €	746 €	652 €
72↔75 x 72↔75	36	36	40	<b>LUNA72M-</b>	●				600 €	680 €	746 €	652 €
78↔81 x 78↔81	39	39	44	<b>LUNA78M-</b>	●				632 €	712 €	786 €	686 €
87↔90 x 87↔90	43,5	43,5	50	<b>LUNA87M-</b>	●				632 €	712 €	786 €	686 €
96↔99 x 96↔99	48	48	57	<b>LUNA96M-</b>	●				700 €	780 €	858 €	750 €
66↔69 x 87↔90	33	43,5	43	<b>LUNA6687M-</b>	●				616 €	696 €	766 €	669 €
66↔69 x 96↔99	33	48	46,5	<b>LUNA6696M-</b>	●	+ 76 €	+ 76 €	+ 76 €	650 €	730 €	802 €	701 €
66↔69 x 117↔120	33	58,5	53,5	<b>LUNA66117M-</b>	●				719 €	799 €	878 €	765 €
72↔75 x 87↔90	36	43,5	45	<b>LUNA7287M-</b>	●				616 €	696 €	766 €	669 €
72↔75 x 96↔99	36	48	48,5	<b>LUNA7296M-</b>	●				650 €	730 €	802 €	701 €
78↔81 x 96↔99	39	48	50,5	<b>LUNA7896M-</b>	●				666 €	746 €	822 €	718 €
78↔81 x 117↔120	39	58,5	57,5	<b>LUNA78117M-</b>	●				735 €	815 €	898 €	782 €
87↔90 x 117↔120	43,5	58,5	60,5	<b>LUNA87117M-</b>	●				735 €	815 €	898 €	782 €

#### POSSIBILITA' DI ORDINARE UN PANNELLO FISSO LATERALE PER INSTALLAZIONE A CENTRO PARETE

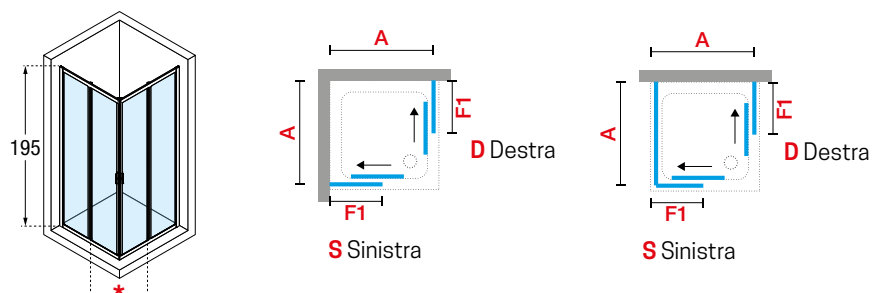

#### OPTIONAL

KIT 4 CARRELLI SGANCIABILI LUNES A-2A		
Finitura	Codice	Prezzo
Bianco	<b>K07LUNM01-A</b>	55 €
Grigio	<b>K07LUNM01-G</b>	55 €





#### FINITURE VETRI



Trasparente  
cod 1



Aqua  
cod 2



Niva  
cod 11



Ser. Lunes 2.0  
cod 78

#### FINITURE PROFILI



Bianco  
cod A

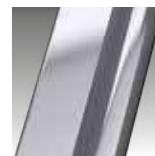

Silver  
cod B



Cromo  
cod K



Argento  
cod J

# LUNES AH

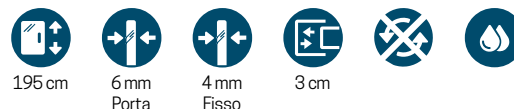

## BOX DOCCIA AD ANGOLO APERTURA 2 ANTE SCORREVOLI E 2 FISSE ANTE SGANCIABILI PER UNA MIGLIORE PULIZIA

Misure			Codice	Destra	Sinistra	Scelta vetro				Scelta profilo			
Misura effettiva d'ingombro	Fisso	Entrata (cm)				1	2	11	78	A	B	K	J
<b>A</b>	<b>F1</b>	*		<b>D-</b>	<b>S-</b>	Trasparente	Aqua	Niva	Serigrafia lunes 2.0	Bianco	Silver	Cromo	Argento
66↔69	33	36	<b>LUNAH66L</b>	D-	S-					365 €	413 €	455 €	398 €
69↔72	34	38	<b>LUNAH69L</b>	D-	S-					365 €	413 €	455 €	398 €
72↔75	36	39	<b>LUNAH72L</b>	D-	S-					365 €	413 €	455 €	398 €
75↔78	37	41	<b>LUNAH75L</b>	D-	S-					365 €	413 €	455 €	398 €
78↔81	39	42	<b>LUNAH78L</b>	D-	S-					387 €	434 €	479 €	418 €
81↔84	40	44	<b>LUNAH81L</b>	D-	S-					387 €	434 €	479 €	418 €
84↔87	42	45	<b>LUNAH84L</b>	D-	S-					387 €	434 €	479 €	418 €
87↔90	43	47	<b>LUNAH87L</b>	D-	S-					387 €	434 €	479 €	418 €
90↔93	45	48	<b>LUNAH90L</b>	D-	S-					428 €	477 €	523 €	458 €
93↔96	46	50	<b>LUNAH93L</b>	D-	S-					428 €	477 €	523 €	458 €
96↔99	48	51	<b>LUNAH96L</b>	D-	S-					428 €	477 €	523 €	458 €
99↔102	49	53	<b>LUNAH99L</b>	D-	S-					428 €	477 €	523 €	458 €
102↔105	51	54	<b>LUNAH102L</b>	D-	S-		+ 38 €	+ 38 €	+ 38 €	468 €	517 €	568 €	495 €
105↔108	52	56	<b>LUNAH105L</b>	D-	S-					468 €	517 €	568 €	495 €
108↔111	54	57	<b>LUNAH108L</b>	D-	S-					468 €	517 €	568 €	495 €
111↔114	55	59	<b>LUNAH111L</b>	D-	S-					468 €	517 €	568 €	495 €
114↔117	57	60	<b>LUNAH114L</b>	D-	S-					509 €	558 €	614 €	537 €
117↔120	60	60	<b>LUNAH117L</b>	D-	S-					509 €	558 €	614 €	537 €
120↔123	63	60	<b>LUNAH120L</b>	D-	S-					509 €	558 €	614 €	537 €
123↔126	66	60	<b>LUNAH123L</b>	D-	S-					509 €	558 €	614 €	537 €
126↔129	69	60	<b>LUNAH126L</b>	D-	S-					564 €	613 €	674 €	590 €
129↔132	72	60	<b>LUNAH129L</b>	D-	S-					564 €	613 €	674 €	590 €
132↔135	75	60	<b>LUNAH132L</b>	D-	S-					605 €	654 €	720 €	627 €
135↔138	78	60	<b>LUNAH135L</b>	D-	S-					605 €	654 €	720 €	627 €
138↔141	81	60	<b>LUNAH138L</b>	D-	S-					648 €	695 €	764 €	668 €
H 160†200	SPECIAL	Destra	<b>LUNAHLDSP</b>	-	-		+ 38 €	+ 38 €	-	675 €	748 €	823 €	718 €
		Sinistra	<b>LUNAHLSP</b>	-	-				-	675 €	748 €	823 €	718 €

### PER COMPORRE UN ANGOLO ORDINARE 2 LATI.

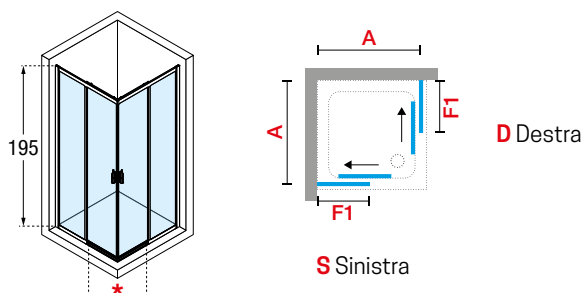

190



Costruzione del codice

**Codice** + **Sinistra/Destra** + **Vetro** + **Profilo** = Codice prodotto finale





#### FINITURE VETRI



Trasparente  
cod 1



Aqua  
cod 2



Niva  
cod 11



Ser. Lunes 2.0  
cod 78

#### FINITURE PROFILI



Bianco  
cod A

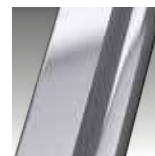

Silver  
cod B



Cromo  
cod K



Argento  
cod J

# LUNES 2P



## PORTA DOCCIA APERTURA 1 ANTA SCORREVOLE E 1 FISSA IN LINEA

Installabile in nicchia o abbinabile ad 1 o 2 pareti fisse laterali LUNES F o FZ

Misure			Codice	Scelta vetro				Scelta profilo			
Misura effettiva d'ingombro	Fisso	Entrata (cm)		1	2	11	78	A	B	K	J
<b>A</b>	<b>F1</b>	*		Trasparente	Aqua	Niva	Serigrafia lunes 2.0	Bianco	Silver	Cromo	Argento
96↔102	47	39	<b>LUN2P96-</b>					547 €	618 €	680 €	595 €
102↔108	50	42	<b>LUN2P102-</b>					547 €	618 €	680 €	595 €
108↔114	53	45	<b>LUN2P108-</b>	●				606 €	677 €	744 €	652 €
114↔120	56	48	<b>LUN2P114-</b>	●				606 €	677 €	744 €	652 €
120↔126	59	51	<b>LUN2P120-</b>					666 €	736 €	811 €	708 €
126↔132	62	54	<b>LUN2P126-</b>		+ 38 €	+ 38 €	+ 38 €	666 €	736 €	811 €	708 €
132↔138	65	57	<b>LUN2P132-</b>					730 €	796 €	876 €	766 €
138↔144	68	60	<b>LUN2P138-</b>	●				730 €	796 €	876 €	766 €
144↔150	71	63	<b>LUN2P144-</b>					793 €	859 €	946 €	826 €
150↔156	74	66	<b>LUN2P150-</b>					793 €	859 €	946 €	826 €
156↔162	77	69	<b>LUN2P156-</b>	●				793 €	859 €	946 €	826 €
H 160±200	SPECIAL		<b>LUN2PSP</b>		+ 38 €	+ 38 €	-	1.015 €	1.102 €	1.212 €	1.058 €

**POSSIBILITA' DI ORDINARE UN PANNELLO FISSO LATERALE PER INSTALLAZIONE A CENTRO PARETE**

### OPTIONAL



**KIT 2 CARRELLI SGANCIABILI LUNES 2P**

Finitura	Codice	Prezzo
Bianco	<b>K07LUN2P1-A</b>	35 €
Grigio	<b>K07LUN2P1-G</b>	35 €

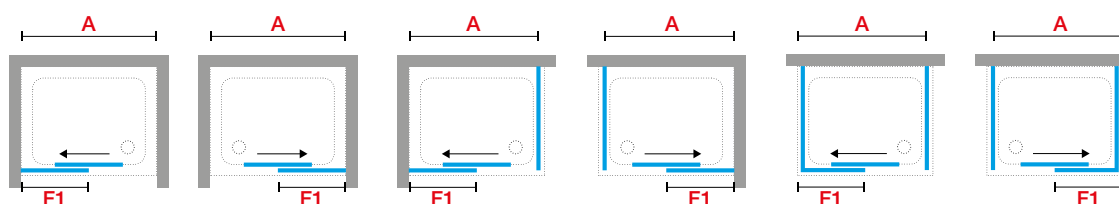
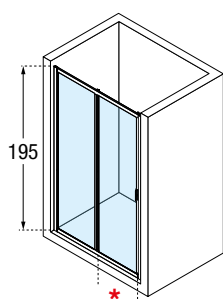



#### FINITURE VETRI



Trasparente  
cod 1



Aqua  
cod 2



Niva  
cod 11



Ser. Lunes 2.0  
cod 78

#### FINITURE PROFILI



Bianco  
cod A

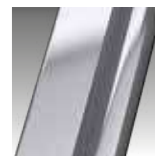

Silver  
cod B



Cromo  
cod K



Argento  
cod J

# LUNES 2PH



## PORTA DOCCIA, APERTURA 1 ANTA SCORREVOLE E 1 ANTA FISSA IN LINEA

Installabile in nicchia o abbinabile ad 1 parete fissa laterale LUNES F o FZ  
 ANTA SGANCIABILE PER UNA FACILE PULIZIA

Misure			Codice	Destra	Sinistra	Scelta vetro				Scelta profilo			
Misura effettiva d'ingombro	Fisso	Entrata (cm)		D-	S-	1	2	11	78	A	B	K	J
<b>A</b>	<b>F1</b>	*				Trasparente	Aqua	Niva	Serigrafia Lunes 2.0	Bianco	Silver	Cromo	Argento
96↔102	46	38	<b>LUN2PH96</b>	D-	S-					638 €	723 €	795 €	694 €
102↔108	49	41	<b>LUN2PH102</b>	D-	S-					638 €	723 €	795 €	694 €
108↔114	52	44	<b>LUN2PH108</b>	D-	S-					709 €	792 €	872 €	762 €
114↔120	55	47	<b>LUN2PH114</b>	D-	S-					709 €	792 €	872 €	762 €
120↔126	58	50	<b>LUN2PH120</b>	D-	S-					778 €	860 €	948 €	827 €
126↔132	61	53	<b>LUN2PH126</b>	D-	S-					778 €	860 €	948 €	827 €
132↔138	64	56	<b>LUN2PH132</b>	D-	S-					853 €	930 €	1.024 €	895 €
138↔144	67	59	<b>LUN2PH138</b>	D-	S-		+ 38 €	+ 38 €	+ 38 €	853 €	930 €	1.024 €	895 €
144↔150	70	62	<b>LUN2PH144</b>	D-	S-					927 €	1.004 €	1.105 €	965 €
150↔156	76	62	<b>LUN2PH150</b>	D-	S-					927 €	1.004 €	1.105 €	965 €
156↔162	82	62	<b>LUN2PH156</b>	D-	S-					927 €	1.004 €	1.105 €	965 €
162↔168	85	65	<b>LUN2PH162</b>	D-	S-					1.000 €	1.080 €	1.189 €	1.039 €
168↔174	91	65	<b>LUN2PH168</b>	D-	S-					1.000 €	1.080 €	1.189 €	1.039 €
174↔180	97	65	<b>LUN2PH174</b>	D-	S-					1.000 €	1.080 €	1.189 €	1.039 €
H 160†200	SPECIAL		<b>LUN2PHDSP</b>	-	-		+ 38 €	+ 38 €	-	1.185 €	1.287 €	1.415 €	1.235 €
			<b>LUN2PHSSP</b>	-	-				-	1.185 €	1.287 €	1.415 €	1.235 €

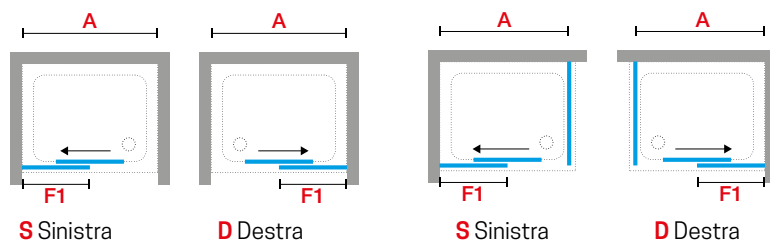
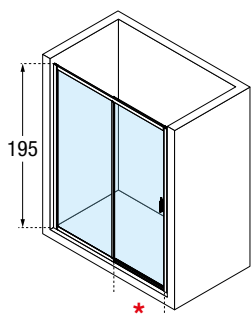



## FINITURE VETRI

Trasparente  
cod 1Aqua  
cod 2Niva  
cod 11Ser. Lunes 2.0  
cod 78

## FINITURE PROFILI

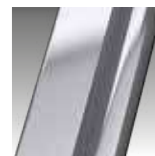
Bianco  
cod ASilver  
cod BCromo  
cod KArgento  
cod J

# LUNES G



## PORTA DOCCIA, APERTURA 1 ANTA BATTENTE, APERTURA IN OUT

Installabile in nicchia o abbinabile ad 1 o 2 pareti fisse laterali LUNES F o FZ

Misure			Codice	Scelta vetro				Scelta profilo			
Misura effettiva d'ingombro	Entrata (cm)	Ingombro anta esterno		1	2	11	78	A	B	K	J
<b>A</b>	*	<b>B</b>		Trasparente	Aqua	Niva	Serigrafia lunes 2.0	Bianco	Silver	Cromo	Argento
60↔66	41	40	<b>LUNG60-</b>					433 €	478 €	524 €	459 €
66↔72	47	46	<b>LUNG66-</b>					433 €	478 €	524 €	459 €
72↔78	53	52	<b>LUNG72-</b>					433 €	478 €	524 €	459 €
78↔84	56	55	<b>LUNG78-</b>	●	+ 38 €	+ 38 €	+ 38 €	465 €	509 €	560 €	490 €
84↔90	62	61	<b>LUNG84-</b>	●				465 €	509 €	560 €	490 €
90↔96	68	67	<b>LUNG90-</b>					499 €	544 €	599 €	523 €
96↔102	74	73	<b>LUNG96-</b>					499 €	544 €	599 €	523 €
H 160†200		SPECIAL	<b>LUNGSP</b>		+ 38 €	+ 38 €	-	634 €	704 €	775 €	677 €

### POSSIBILITA' DI ORDINARE UN PANNELLO FISSO LATERALE PER INSTALLAZIONE A CENTRO PARETE

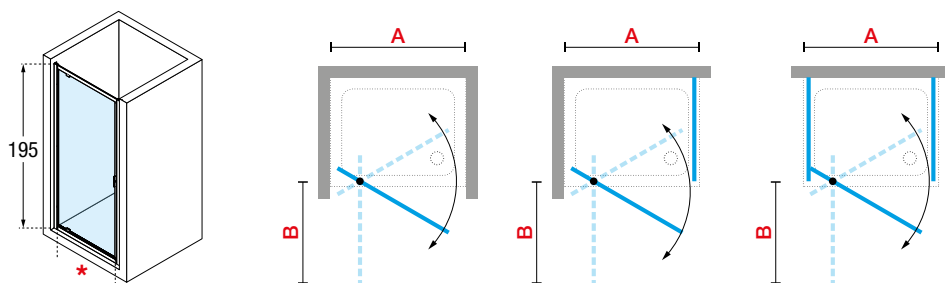



## FINITURE VETRI

Trasparente  
cod 1Aqua  
cod 2Niva  
cod 11Ser. Lunes 2.0  
cod 78

## FINITURE PROFILI

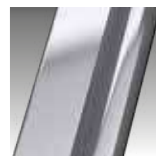
Bianco  
cod ASilver  
cod BCromo  
cod KArgento  
cod J

# LUNES B



195 cm



5 mm



6 cm



## PORTA DOCCIA, APERTURA 2 ANTE BATTENTI, APERTURA IN/OUT

Installabile in nicchia o abbinabile ad 1 o 2 pareti fisse laterali LUNES F o FZ



### FINITURE VETRI



### FINITURE PROFILI



Misure			Codice	Scelta vetro				Scelta profilo			
Misura effettiva d'ingombro	Entrata (cm)	Ingombro anta esterno		1	2	11	78	A	B	K	J
<b>A</b>	<b>*</b>	<b>B</b>		Trasparente	Aqua	Niva	Serigrafia lunes 2.0	Bianco	Silver	Cromo	Argento
60↔66	40	19	<b>LUNB60-</b>					517 €	581 €	640 €	559 €
66↔72	46	22	<b>LUNB66-</b>					517 €	581 €	640 €	559 €
72↔78	52	25	<b>LUNB72-</b>					517 €	581 €	640 €	559 €
78↔84	50	24	<b>LUNB78-</b>					571 €	634 €	697 €	610 €
84↔90	56	27	<b>LUNB84-</b>	●	+ 38 €	+ 38 €	+ 38 €	571 €	634 €	697 €	610 €
90↔96	62	30	<b>LUNB90-</b>					571 €	634 €	697 €	610 €
96↔102	62	30	<b>LUNB96-</b>	●				630 €	692 €	761 €	666 €
102↔108	68	33	<b>LUNB102-</b>					630 €	692 €	761 €	666 €
108↔114	74	36	<b>LUNB108-</b>					630 €	692 €	761 €	666 €
114↔120	80	39	<b>LUNB114-</b>	●				630 €	692 €	761 €	666 €
H 158±200		SPECIAL	<b>LUNBSP</b>		+ 38 €	+ 38 €	-	706 €	796 €	876 €	766 €

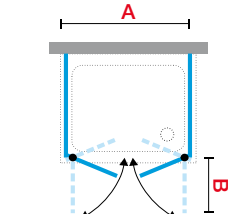
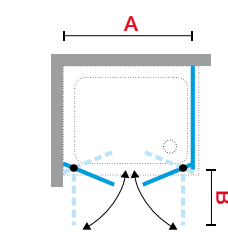
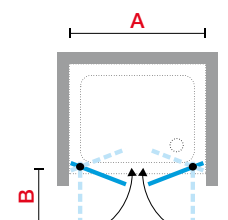
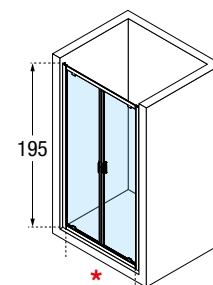

**POSSIBILITA' DI ORDINARE UN PANNELLO FISSO LATERALE PER INSTALLAZIONE A CENTRO PARETE**





# LUNES S



195 cm



4 mm



6 cm



## PORTA DOCCIA, APERTURA 2 ANTE A SOFFIETTO

Installabile in nicchia o abbinabile ad 1 o 2 pareti fisse laterali LUNES F o FZ



### FINITURE VETRI



Trasparente  
cod 1

Aqua  
cod 2

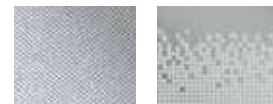

Niva  
cod 11

Ser. Lunes 2.0  
cod 78

### FINITURE PROFILI

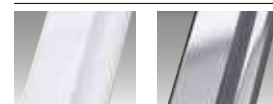

Bianco  
cod A

Silver  
cod B



Cromo  
cod K

Argento  
cod J

Misure				Codice	Scelta vetro				Scelta profilo			
Misura effettiva d'ingombro	Entrata (cm)	Ingombro anta esterno			1	2	11	78	A	B	K	J
A	*	B	B1		Trasparente	Aqua	Niva	Serigrafia lunes 2.0	Bianco	Silver	Cromo	Argento
60↔66	42	26	24	<b>LUNS60-</b>					588 €	664 €	664 €	639 €
66↔72	48	29	27	<b>LUNS66-</b>					588 €	664 €	664 €	639 €
72↔78	54	32	30	<b>LUNS72-</b>					588 €	664 €	664 €	639 €
78↔84	60	35	33	<b>LUNS78-</b>	●	+ 38 €	+ 38 €	+ 38 €	639 €	717 €	717 €	688 €
84↔90	66	38	36	<b>LUNS84-</b>	●				639 €	717 €	717 €	688 €
90↔96	72	41	39	<b>LUNS90-</b>					690 €	766 €	766 €	737 €
96↔102	78	44	42	<b>LUNS96-</b>	●				690 €	766 €	766 €	737 €
H 160↔200		SPECIAL		<b>LUNSSP</b>		+ 38 €	+ 38 €	-	785 €	876 €	876 €	842 €

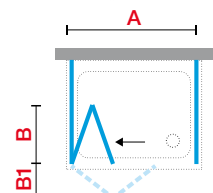
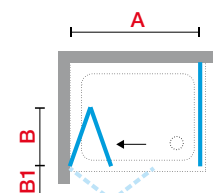
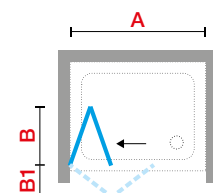
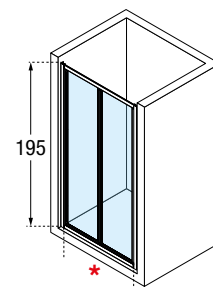

### POSSIBILITA' DI ORDINARE UN PANNELLO FISSO LATERALE PER INSTALLAZIONE A CENTRO PARETE



#### APERTURA DI SICUREZZA.

**ATTENZIONE: L'APERTURA VERSO L'ESTERNO DEVE ESSERE CONSIDERATA SOLAMENTE COME APERTURA D'EMERGENZA**

Costruzione del codice + Codice + Vetro + Profilo = Codice prodotto finale



# LUNES 3P



195 cm



4 mm



6 cm



## PORTA DOCCIA APERTURA 3 ANTE SCORREVOLI BILATERALE DA DESTRA E DA SINISTRA

Installabile in nicchia o abbinabile ad 1 o 2 pareti fisse laterali LUNES F o FZ

Misure		Codice	Scelta vetro				Scelta profilo			
Misura effettiva d'ingombro	Entrata (cm)		1	2	11	78	A	B	K	J
<b>A</b>	*		Trasparente	Aqua	Niva	Serigrafia lunes 2.0	Bianco	Silver	Cromo	Argento
78↔84	37	<b>LUN3P78-</b>					596 €	678 €	746 €	651 €
84↔90	41	<b>LUN3P84-</b>					659 €	741 €	816 €	711 €
90↔96	45	<b>LUN3P90-</b>					659 €	741 €	816 €	711 €
96↔102	49	<b>LUN3P96-</b>	●				659 €	741 €	816 €	711 €
102↔108	53	<b>LUN3P102-</b>	●				723 €	804 €	884 €	774 €
108↔114	57	<b>LUN3P108-</b>	●	+ 38 €	+ 38 €	+ 38 €	723 €	804 €	884 €	774 €
114↔120	61	<b>LUN3P114-</b>	●				723 €	804 €	884 €	774 €
120↔126	65	<b>LUN3P120-</b>					792 €	867 €	955 €	833 €
126↔132	69	<b>LUN3P126-</b>					792 €	867 €	955 €	833 €
132↔138	73	<b>LUN3P132-</b>					792 €	867 €	955 €	833 €
138↔144	77	<b>LUN3P138-</b>					792 €	867 €	955 €	833 €
H 160±200	SPECIAL	<b>LUN3PSP</b>		+ 38 €	+ 38 €	-	931 €	1.045 €	1.148 €	1.004 €

### POSSIBILITA' DI ORDINARE UN PANNELLO FISSO LATERALE PER INSTALLAZIONE A CENTRO PARETE

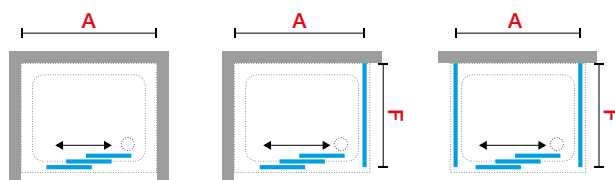
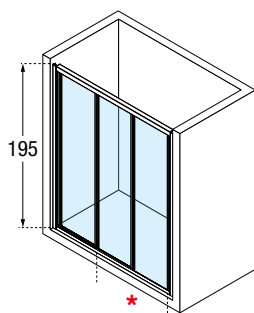

200



Costruzione del codice

Codice

+

Vetro

+

Profilo

=

Codice prodotto finale





#### FINITURE VETRI



Trasparente  
cod 1



Aqua  
cod 2



Niva  
cod 11



Ser. Lunes 2.0  
cod 78

#### FINITURE PROFILI



Bianco  
cod A

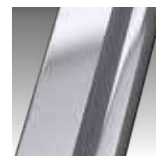

Silver  
cod B



Cromo  
cod K



Argento  
cod J

# LUNES 3PH

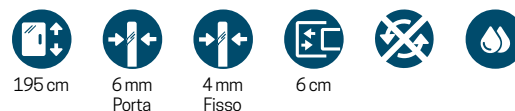

## PORTA DOCCIA, APERTURA 3 ANTE, 2 SCORREVOLI + 1 FISSA

Installabile in nicchia o abbinabile ad 1 pareti fisse laterale LUNES F o FZ



### FINITURE VETRI



### FINITURE PROFILI



Misure			Codice	Destra	Sinistra	Scelta vetro				Scelta profilo			
Misura effettiva d'ingombro	Fisso	Entrata (cm)				1	2	11	78	A	B	K	J
<b>A</b>	<b>F1</b>	<b>*</b>				Trasparente	Aqua	Niva	Serigrafia Lunes 2.0	Bianco	Silver	Cromo	Argento
78↔84	26,5	39	<b>LUN3PH78</b>	D-	S-					670 €	763 €	840 €	712 €
84↔90	28,5	43	<b>LUN3PH84</b>	D-	S-					742 €	835 €	918 €	777 €
90↔96	30,5	47	<b>LUN3PH90</b>	D-	S-					742 €	835 €	918 €	777 €
96↔102	32,5	51	<b>LUN3PH96</b>	D-	S-					742 €	835 €	918 €	777 €
102↔108	34,5	55	<b>LUN3PH102</b>	D-	S-					813 €	905 €	995 €	844 €
108↔114	36,5	59	<b>LUN3PH108</b>	D-	S-		+ 38 €	+ 38 €	+ 38 €	813 €	905 €	995 €	844 €
114↔120	38,5	63	<b>LUN3PH114</b>	D-	S-					813 €	905 €	995 €	844 €
120↔126	40,5	67	<b>LUN3PH120</b>	D-	S-					892 €	977 €	1.074 €	909 €
126↔132	42,5	71	<b>LUN3PH126</b>	D-	S-					892 €	977 €	1.074 €	909 €
132↔138	44,5	75	<b>LUN3PH132</b>	D-	S-					892 €	977 €	1.074 €	909 €
138↔144	46,5	79	<b>LUN3PH138</b>	D-	S-					892 €	977 €	1.074 €	909 €
H			<b>LUN3PHDSP</b>	D	-					1.033 €	1.158 €	1.273 €	1.080 €
160↔200	SPECIAL		<b>LUN3PHSSP</b>	S	-		+ 38 €	+ 38 €	-	1.033 €	1.158 €	1.273 €	1.080 €

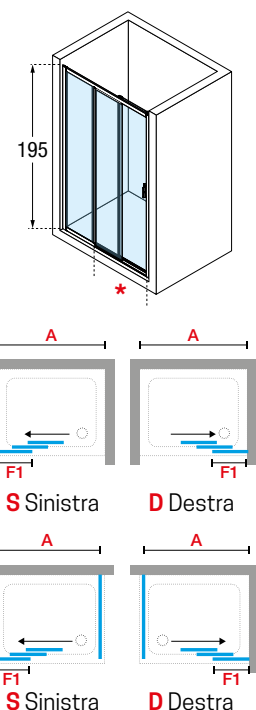

# LUNES 2A



195 cm



4 mm



6 cm



## PORTA DOCCIA APERTURA 2 ANTE SCORREVOLI E 2 FISSE IN LINEA

Installabile in nicchia o abbinabile ad 1 o 2 pareti fisse laterali LUNES F o FZ



### FINITURE VETRI



Traspacente  
cod 1

Aqua  
cod 2

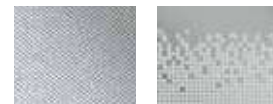

Niva  
cod 11

Ser. Lunes 2.0  
cod 78

### FINITURE PROFILI

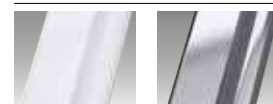

Bianco  
cod A

Silver  
cod B



Cromo  
cod K

Argento  
cod J

Misure			Codice	Scelta vetro				Scelta profilo			
Misura effettiva d'ingombro	Fisso	Entrata (cm)		1	2	11	78	A	B	K	J
<b>A</b>	<b>F1</b>	*		Traspacente	Aqua	Niva	Serigrafia lunes 2.0	Bianco	Silver	Cromo	Argento
116↔122	31,5	48	<b>LUN2A116-</b>					880 €	990 €	1.089 €	952 €
122↔128	33	51	<b>LUN2A122-</b>					880 €	990 €	1.089 €	952 €
128↔134	34,5	54	<b>LUN2A128-</b>					880 €	990 €	1.089 €	952 €
134↔140	36	57	<b>LUN2A134-</b>					880 €	990 €	1.089 €	952 €
140↔146	37,5	60	<b>LUN2A140-</b>					949 €	1.059 €	1.123 €	1.015 €
146↔152	39	63	<b>LUN2A146-</b>	+76 €	+76 €	+76 €		949 €	1.059 €	1.123 €	1.015 €
152↔158	40,5	66	<b>LUN2A152-</b>					949 €	1.059 €	1.123 €	1.015 €
158↔164	42	69	<b>LUN2A158-</b>					949 €	1.059 €	1.123 €	1.015 €
164↔170	43,5	72	<b>LUN2A164-</b>					1.017 €	1.127 €	1.240 €	1.082 €
170↔176	45	75	<b>LUN2A170-</b>					1.017 €	1.127 €	1.240 €	1.082 €
176↔182	46,5	78	<b>LUN2A176-</b>					1.017 €	1.127 €	1.240 €	1.082 €

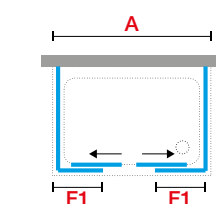
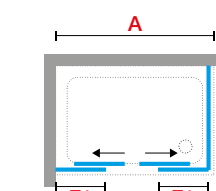
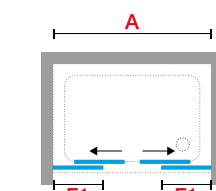
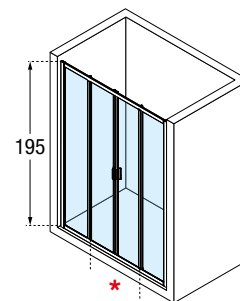

**POSSIBILITA' DI ORDINARE UN PANNELLO FISSO LATERALE PER INSTALLAZIONE A CENTRO PARETE**

### OPTIONAL



**KIT 4 CARRELLI SGANCIABILI LUNES A-2A**

Finitura	Codice	Prezzo
Bianco	<b>K07LUNMO1-A</b>	55 €
Grigio	<b>K07LUNMO1-G</b>	55 €

Costruzione del codice **Codice** + **Vetro** + **Profilo** = Codice prodotto finale

# LUNES G+F IN LINEA



195 cm



5 mm  
Porta



4 mm  
pareti



6 cm



## PORTA DOCCIA APERTURA 1 ANTA BATTENTE E 1 FISSO IN LINEA

Installabile in nicchia o abbinabile ad 1 o 2 pareti fisse laterali LUNES F o FZ



### FINITURE VETRI



Trasparente  
cod 1



Aqua  
cod 2



Niva  
cod 11



Ser. Lunes 2.0  
cod 78

### FINITURE PROFILI



Bianco  
cod A



Silver  
cod B



Cromo  
cod K



Argento  
cod J

Misure				Codice	Scelta vetro				Scelta profilo			
Misura effettiva d'ingombro	Fisso	Entrata (cm)	Ingombro anta esterno		1	2	11	78	A	B	K	J
<b>A</b>	<b>F1</b>	*	<b>B</b>		Trasparente	Aqua	Niva	Serigrafia Lunes 2.0	Bianco	Silver	Cromo	Argento
96↔102	34	41	46	<b>LUNGF96-</b>					710 €	797 €	875 €	764 €
102↔108	34	53	52	<b>LUNGF102-</b>					710 €	797 €	875 €	764 €
108↔114	34	56	55	<b>LUNGF108-</b>					710 €	797 €	875 €	764 €
114↔120	46	53	52	<b>LUNGF114-</b>					783 €	868 €	957 €	835 €
120↔126	46	56	55	<b>LUNGF120-</b>	+ 38 €	+ 38 €	+ 38 €		783 €	868 €	957 €	835 €
126↔132	46	62	61	<b>LUNGF126-</b>					783 €	868 €	957 €	835 €
132↔138	58	56	55	<b>LUNGF132-</b>					855 €	950 €	1.044 €	914 €
138↔144	58	62	61	<b>LUNGF138-</b>					855 €	950 €	1.044 €	914 €
144↔150	58	68	67	<b>LUNGF144-</b>					855 €	950 €	1.044 €	914 €

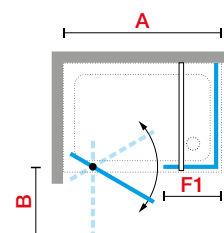
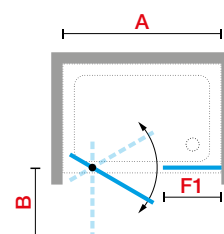
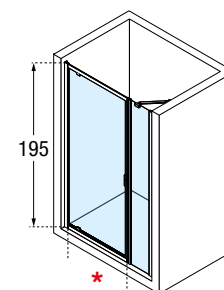

### OPTIONAL



#### BARRA DI SOSTEGNO 150 cm

da ordinare in caso di installazione con fisso laterale

Finitura	Codice	Prezzo
Bianco	<b>R80SMAH15-A</b>	104 €
Silver	<b>R80SMAH15-B</b>	117 €
Cromo	<b>R80SMAH15-K</b>	129 €
Argento	<b>R80SMAH15-J</b>	109 €

# LUNES R



BOX DOCCIA AD ANGOLO SEMICIRCOLARE, APERTURA 2 ANTE SCORREVOLI E 2 FISSE



## FINITURE VETRI



## FINITURE PROFILI



Misure					Codice	Scelta vetro				Scelta profilo			
Misura effettiva d'ingombro	Fisso	Entrata (cm)				1	2	11	78	A	B	K	J
A	F1	F2	*	R		Trasparente	Aqua	Niva	Serigrafia lunes 2.0	Bianco	Silver	Cromo	Argento
<b>VERSIONE SIMMETRICA</b>													
72↔75	33	-	41	40	LUNR75-					1.035 €	1.158 €	1.273 €	1.112 €
77↔80	23	-	40	55	LUNR80-					1.035 €	1.158 €	1.273 €	1.112 €
87↔90	33	-	56	55	LUNR90-	+ 76 €	+ 76 €	+ 76 €		1.035 €	1.158 €	1.273 €	1.112 €
97↔100	43	-	56	55	LUNR100-					1.035 €	1.158 €	1.273 €	1.112 €
<b>VERSIONE ASIMMETRICA</b>													
72↔75 x 87↔90	22	42	46	45,8	LUNR7590-					1.035 €	1.158 €	1.273 €	1.112 €
77↔80 x 87↔90	23	33	48	55	LUNR8090-					1.035 €	1.158 €	1.273 €	1.112 €
77↔80 x 97↔100	23	43	48	55	LUNR80100-					1.035 €	1.158 €	1.273 €	1.112 €
77↔80 x 117↔120	23	63	48	55	LUNR80120-	+ 76 €	+ 76 €	+ 76 €		1.035 €	1.158 €	1.273 €	1.112 €
87↔90 x 117↔120	33	63	56	55	LUNR90120-					1.035 €	1.158 €	1.273 €	1.112 €
* 67↔70 x 87↔90	30	50	40	38	LUNR7090W-					1.035 €	1.158 €	1.273 €	1.112 €
* 77↔80 x 97↔100	40	60	40	38	LUNR80100W-					1.035 €	1.158 €	1.273 €	1.112 €
* 77↔80 x 117↔120	40	80	40	38	LUNR80120W-					1.035 €	1.158 €	1.273 €	1.112 €

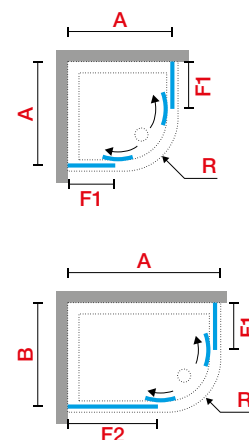
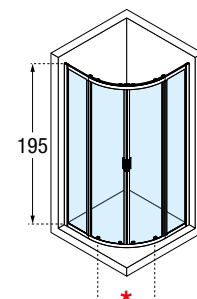

## OPTIONAL

	KIT 4 CARRELLI SGANCIABILI LUNES R		
	Finitura	Codice	Prezzo
	Bianco	K07LUNR01-A	75 €
Grigio	K07LUNR01-G	75 €	

\* MODELLO COMPATIBILE CON PIATTI SWIM DOLOMITE

Costruzione del codice + Codice + Vetro + Profilo = Codice prodotto finale

# LUNES PENTAGONO G



BOX DOCCIA PENTAGONALE APERTURA 1 ANTA BATTENTE CON 2 FISSE



## FINITURE VETRI



## FINITURE PROFILI



Misure				Codice	Scelta vetro				Scelta profilo			
Misura effettiva d'ingombro	Fisso	Entrata (cm)	Ingombro esterno		1	2	11	78	A	B	K	J
<b>A</b>	<b>F1 F2</b>	<b>*</b>	<b>B</b>		Trasparente	Aqua	Niva	Serigrafia lunes 2.0	Bianco	Silver	Cromo	Argento
88,5↔91,5	40 40	47	46	<b>LUNPG90-</b>					955 €	1.067 €	1.175 €	1.025 €
98,5↔101,5	50 50	47	46	<b>LUNPG100-</b>					955 €	1.067 €	1.175 €	1.025 €
88,5↔91,5 x 118,5↔121,5	70 40	47	46	<b>LUNPG120-</b>		+38 €	+38 €	+38 €	1.097 €	1.205 €	1.328 €	1.159 €
88,5↔91,5 x 138,5↔141,5	90 40	47	46	<b>LUNPG140-</b>					1.097 €	1.205 €	1.328 €	1.159 €

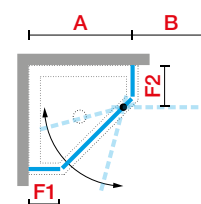
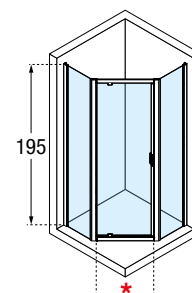



# LUNES F



195 cm



4 mm



6 cm



## PARETE FISSA LATERALE

Per porte doccia LUNES



### FINITURE VETRI



Trasparente  
cod 1



Aqua  
cod 2



Niva  
cod 11



Ser. Lunes 2.0  
cod 78

### FINITURE PROFILI



Bianco  
cod A



Silver  
cod B



Cromo  
cod K



Argento  
cod J

Misure	Codice	Scelta vetro				Scelta profilo			
		1	2	11	78	A	B	K	J
Misura effettiva d'ingombro		Trasparente	Aqua	Niva	Serigrafia lunes 2.0	Bianco	Silver	Cromo	Argento
<b>F</b>									
66↔72	<b>LUNF66-</b>					285 €	322 €	356 €	311 €
72↔78	<b>LUNF72-</b>					285 €	322 €	356 €	311 €
78↔84	<b>LUNF78-</b>	●				285 €	322 €	356 €	311 €
84↔90	<b>LUNF84-</b>	●	+ 38 €	+ 38 €	+ 38 €	322 €	360 €	396 €	346 €
90↔96	<b>LUNF90-</b>					322 €	360 €	396 €	346 €
96↔102	<b>LUNF96-</b>	●				348 €	384 €	424 €	370 €

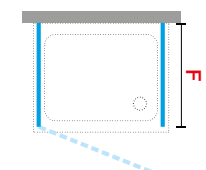
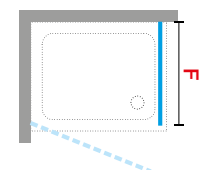
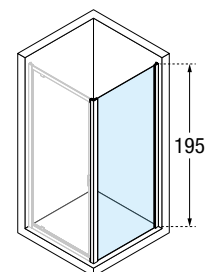

**PER LE SOLUZIONI CON DUE PANNELLI FISSI LATERALI  
UTILIZZARE SEMPRE 2 BARRE DI SOSTEGNO AD ANGOLO.**

Costruzione del codice    **Codice** + **Vetro** + **Profilo** = Codice prodotto finale



# LUNES FZ



## PARETE FISSA LATERALE

Per porte doccia LUNES



### FINITURE VETRI



### FINITURE PROFILI



Misure	Codice	Scelta vetro				Scelta profilo			
Misura effettiva d'ingombro		1	2	11	78	A	B	K	J
<b>F</b>		Trasparente	Aqua	Niva	Serigrafia lunes 2.0	Bianco	Silver	Cromo	Argento
68↔71	<b>LUNFZ68-</b>					291 €	316 €	340 €	303 €
73↔76	<b>LUNFZ73-</b>					291 €	316 €	340 €	303 €
78↔81	<b>LUNFZ78-</b>	●				303 €	327 €	352 €	316 €
83↔86	<b>LUNFZ83-</b>	●	+ 38 €	+ 38 €	+ 38 €	303 €	327 €	352 €	316 €
88↔91	<b>LUNFZ88-</b>					316 €	340 €	364 €	329 €
93↔96	<b>LUNFZ93-</b>					316 €	340 €	364 €	329 €
98↔101	<b>LUNFZ98-</b>	●				328 €	353 €	378 €	342 €
H 160↔200 L 23↔118 SPECIAL	<b>LUNFZSP</b>		+ 38 €	+ 38 €	-	382 €	429 €	475 €	398 €

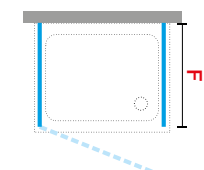
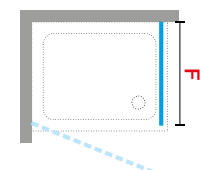
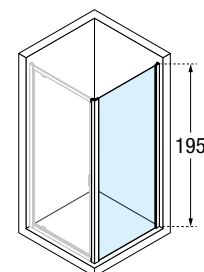

**PER LE SOLUZIONI CON DUE PANNELLI FISSI LATERALI  
UTILIZZARE SEMPRE 2 BARRE DI SOSTEGNO AD ANGOLO.**



# LUNES F (SOLO PROFILI)

Altezza H 1950 mm



195 cm



## FINITURE PROFILI



Bianco  
cod A



Silver  
cod B



Cromo  
cod K



Argento  
cod J

Misure	Codice	Scelta profilo			
		A	B	K	J
		Bianco	Silver	Cromo	Argento
<b>FISSAGGIO FRONTALE (DISEGNO A)</b>					
4↔6,7	<b>LUNF46ST-</b>	87 €	100 €	111 €	96 €
6,8↔9,1	<b>LUNF69ST-</b>	124 €	144 €	157 €	139 €
9,2↔11,4	<b>LUNF911ST-</b>	138 €	155 €	171 €	149 €
11,5↔16	<b>LUNF1116ST-</b>	149 €	167 €	186 €	162 €
16,1↔20	<b>LUNF1620ST-</b>	167 €	186 €	205 €	180 €
<b>FISSAGGIO LATERALE (DISEGNO B)</b>					
4↔6,7	<b>LUNF46STL-</b>	112 €	124 €	138 €	120 €
6,8↔9,1	<b>LUNF69STL-</b>	155 €	175 €	192 €	167 €
9,2↔11,4	<b>LUNF911STL-</b>	162 €	181 €	199 €	174 €
11,5↔16	<b>LUNF1116STL-</b>	181 €	199 €	219 €	192 €
16,1↔20	<b>LUNF1620STL-</b>	193 €	211 €	232 €	202 €

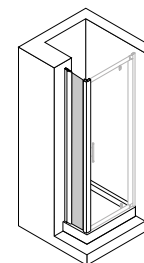

A

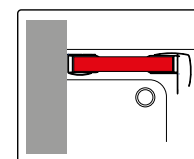

B

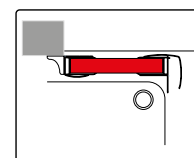

# LUNES F SPECIAL 1



195 cm



4 mm



6 cm



**PARETE FISSA SPECIALE, SPECIALE IN LARGHEZZA E ALTEZZA**

Per porte doccia LUNES



## FINITURE VETRI



Trasparente  
cod 1



Aqua  
cod 2



Niva  
cod 11

## FINITURE PROFILI



Bianco  
cod A



Silver  
cod B



Cromo  
cod K



Argento  
cod J

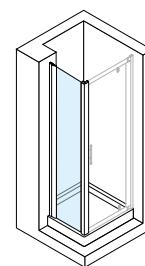

Misure	Codice	Scelta vetro			Scelta profilo			
		1	2	11	A	B	K	J
		Trasparente	Aqua	Niva	Bianco	Silver	Cromo	Argento
L 20↔39,9	<b>LUNFSP</b>				394 €	444 €	489 €	427 €
L 40↔65,9	<b>LUNFSP</b>		+ 38 €		411 €	462 €	509 €	445 €
L 66↔79,9	<b>LUNFSP</b>			+ 38 €	432 €	482 €	531 €	463 €
L 80↔100	<b>LUNFSP</b>				451 €	500 €	552 €	481 €

H 63↔200

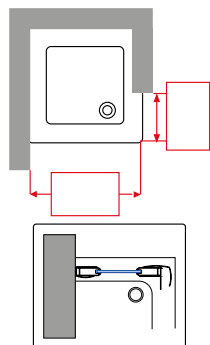
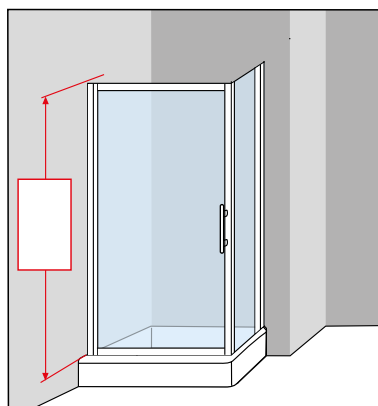

**FISSI SPECIALI IN LARGHEZZA. ALTEZZA DA 63 A 200 CM (SPECIFICARE MISURA ESATTA NELL'ORDINE)**

**PER ALTRE CONFIGURAZIONI O FATTIBILITÀ DELLE MISURE CONTATTARE IL SERVIZIO CLIENTI O CONSULTARE [HTTP://STORE.NOVELLINI.COM](http://store.novellini.com)**



# LUNES F SPECIAL 2



195 cm



4 mm



6 cm



## PARETE FISSA SPECIALE, SAGOMATA 5 LATI

Per porte doccia LUNES



### FINITURE VETRI



Trasparente  
cod 1



Aqua  
cod 2



Niva  
cod 11

### FINITURE PROFILI



Bianco  
cod A



Silver  
cod B



Cromo  
cod K



Argento  
cod J

Misure	Codice	Scelta vetro			Scelta profilo			
		1	2	11	A	B	K	J
		Trasparente	Aqua	Niva	Bianco	Silver	Cromo	Argento
L 30↔39,9	<b>LUNF2SP</b>				538 €	601 €	663 €	578 €
L 40↔65,9	<b>LUNF2SP</b>		+ 38 €		590 €	660 €	725 €	634 €
L 66↔89,9	<b>LUNF2SP</b>			+ 38 €	641 €	716 €	788 €	688 €
L 90↔100	<b>LUNF2SP</b>				672 €	753 €	830 €	723 €

H 93↕200

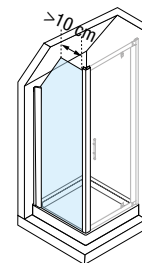

**S** Sinistra

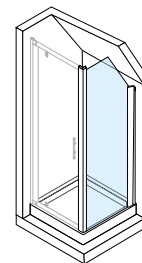

**D** Destra

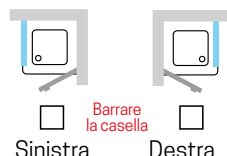
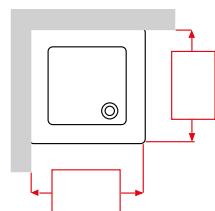
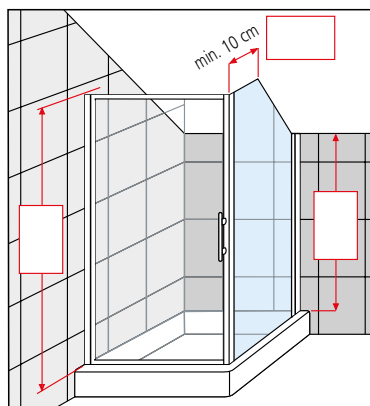

**FISSI SPECIALI IN LARGHEZZA. ALTEZZA DA 93 A 200 CM (SPECIFICARE MISURA ESATTA NELL'ORDINE)**

**PER ALTRE CONFIGURAZIONI O FATTIBILITÀ DELLE MISURE CONTATTARE IL SERVIZIO CLIENTI O CONSULTARE [HTTP://STORE.NOVELLINI.COM](http://store.novellini.com)**

Costruzione del codice    **Codice** + **Vetro** + **Profilo** = Codice prodotto finale

# LUNES F SPECIAL 3



195 cm



4 mm



6 cm



## PARETE FISSA SPECIALE, SAGOMATA 6 LATI

Per porte doccia LUNES



### FINITURE VETRI



Trasparente  
cod 1



Aqua  
cod 2



Niva  
cod 11

### FINITURE PROFILI



Bianco  
cod A



Silver  
cod B



Cromo  
cod K



Argento  
cod J

Misure	Codice	Scelta vetro			Scelta profilo			
		1	2	11	A	B	K	J
L 67↔89,9	<b>LUNF3SP</b>	Trasparente	Aqua	Niva	Bianco	Silver	Cromo	Argento
L 90↔110	<b>LUNF3SP</b>		+ 38 €	+ 38 €	660 €	736 €	810 €	707 €
H 110↔200					685 €	760 €	837 €	730 €

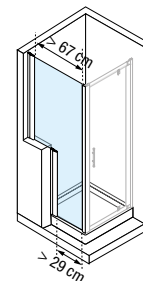

**S** Sinistra

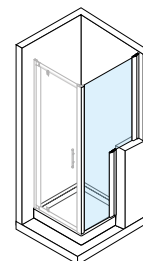

**D** Destra

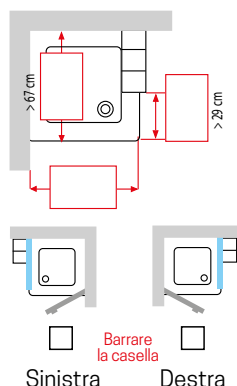
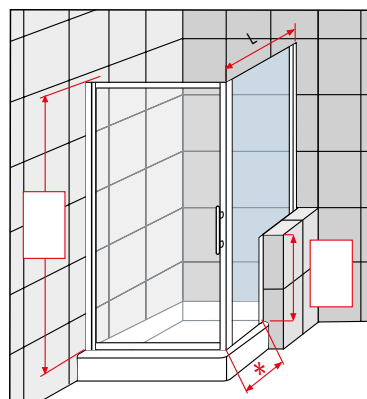

\*  $\geq L/3$ : LA QUOTA DI \* DEVE ESSERE MAGGIORE DI 1/3 DELLA LUCE SUPERIORE E COMUNQUE NON INFERIORE A 29 cm.

**FISSI SPECIALI IN LARGHEZZA. ALTEZZA DA 110 A 200 CM (SPECIFICARE MISURA ESATTA NELL'ORDINE)**

**PER ALTRE CONFIGURAZIONI O FATTIBILITÀ DELLE MISURE CONTATTARE IL SERVIZIO CLIENTI O CONSULTARE [HTTP://STORE.NOVELLINI.COM](http://store.novellini.com)**



# LUNES F SPECIAL 4



195 cm



4 mm



6 cm



**PARETE FISSA SPECIALE, PER INSTALLAZIONE SU MURETTO, SPECIALE IN LARGHEZZA ED ALTEZZA**

Per porte doccia LUNES



## FINITURE VETRI



Trasparente  
cod 1



Aqua  
cod 2



Niva  
cod 11

## FINITURE PROFILI



Bianco  
cod A



Silver  
cod B



Cromo  
cod K



Argento  
cod J

Misure	Codice	Scelta vetro			Scelta profilo			
		1	2	11	A	B	K	J
L 20↔39,9	<b>LUNF4SP</b>	Trasparente	Aqua	Niva	Bianco	Silver	Cromo	Argento
L 40↔65,9	<b>LUNF4SP</b>		+ 38 €	+ 38 €	388 €	437 €	481 €	419 €
L 66↔89,9	<b>LUNF4SP</b>				419 €	470 €	517 €	451 €
L 90↔102	<b>LUNF4SP</b>				456 €	515 €	567 €	495 €
					495 €	552 €	607 €	529 €

H 25↔195

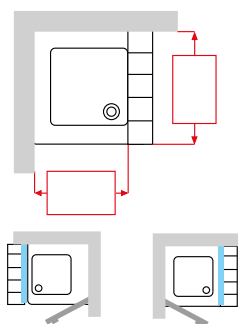
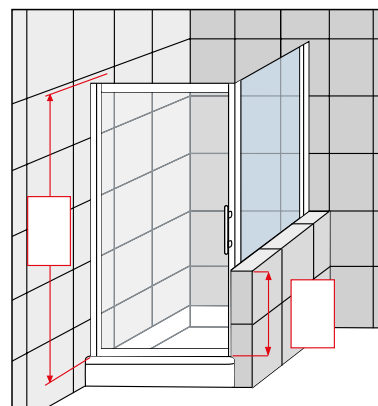
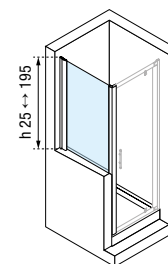

Reversibile

**FISSI SPECIALI IN LARGHEZZA. ALTEZZA DA 25 A 190 CM (SPECIFICARE MISURA ESATTA NELL'ORDINE)**

**PER ALTRE CONFIGURAZIONI O FATTIBILITÀ DELLE MISURE CONTATTARE IL SERVIZIO CLIENTI O CONSULTARE [HTTP://STORE.NOVELLINI.COM](http://store.novellini.com)**

Costruzione del codice    **Codice** + **Vetro** + **Profilo** = Codice prodotto finale

# LUNES F SPECIAL 5



**PARETE FISSA SPECIALE, IN LINEA / PARETE DIVISORIA / FISSAGGIO A MURO LATERALE / PROFILO CHIUSO**

Per porte doccia LUNES



**FISSAGGIO IN LINEA**



**PARETE DIVISORIA**



**FISSAGGIO A MURO LATERALE**



**PROFILO CHIUSO**

## FISSAGGIO IN LINEA

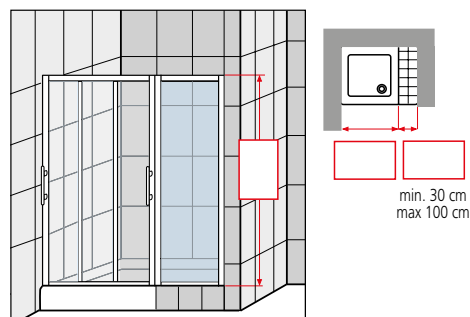

## PARETE DIVISORIA

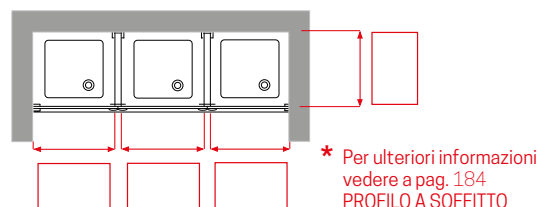
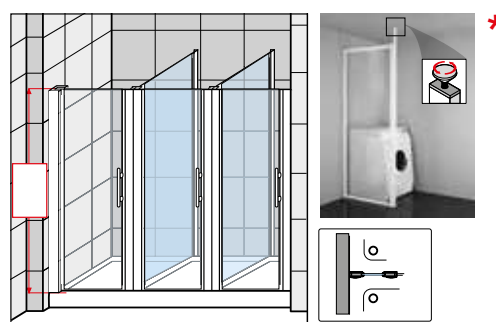

## FISSAGGIO A MURO LATERALE

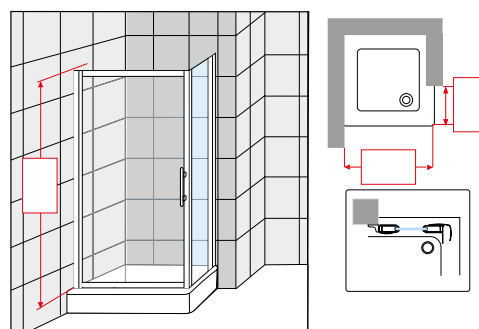

## PROFILO CHIUSO

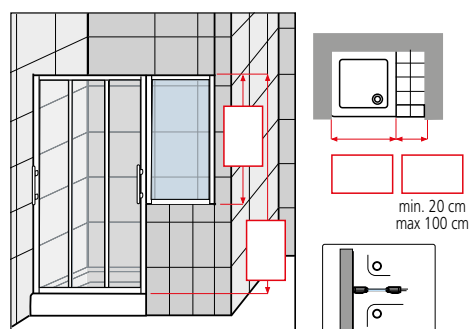

Misure	Codice	Scelta vetro			Scelta profilo			
		1	2	11	A	B	K	J
		Trasparente	Aqua	Niva	Bianco	Silver	Cromo	Argento

### FISSI IN LINEA E PROFILI CHIUSI

H 25↔59,9	<b>LUNF5SP</b>				394 €	444 €	489 €	427 €
H 60↔95,9	<b>LUNF5SP</b>				444 €	495 €	545 €	475 €
H 96↔159,9	<b>LUNF5SP</b>	+ 38 €	+ 38 €		475 €	538 €	594 €	518 €
H 160↔189,9	<b>LUNF5SP</b>				507 €	570 €	627 €	549 €
H 190↔200	<b>LUNF5SP</b>				538 €	601 €	663 €	578 €

### PARETE DIVISORIA

H 25↔59,9	<b>LUNF5SP</b>				426 €	482 €	531 €	463 €
H 60↔95,9	<b>LUNF5SP</b>				475 €	532 €	587 €	511 €
H 96↔159,9	<b>LUNF5SP</b>	+ 38 €	+ 38 €		507 €	570 €	627 €	549 €
H 160↔189,9	<b>LUNF5SP</b>				538 €	601 €	663 €	578 €
H 190↔200	<b>LUNF5SP</b>				570 €	633 €	697 €	608 €

### FISSAGGIO LATERALE

H 25↔59,9	<b>LUNF5SP</b>				456 €	515 €	567 €	495 €
H 60↔95,9	<b>LUNF5SP</b>				507 €	564 €	622 €	543 €
H 96↔159,9	<b>LUNF5SP</b>	+ 38 €	+ 38 €		538 €	601 €	663 €	578 €
H 160↔189,9	<b>LUNF5SP</b>				570 €	633 €	697 €	608 €
H 190↔200	<b>LUNF5SP</b>				608 €	672 €	741 €	645 €

**FISSI SPECIALI IN ALTEZZA. LARGHEZZA DA 20 A 100 CM (SPECIFICARE MISURA ESATTA NELL'ORDINE) PER ALTRE CONFIGURAZIONI O FATTIBILITÀ DELLE MISURE CONTATTARE IL SERVIZIO CLIENTI O CONSULTARE [HTTP://STORE.NOVELLINI.COM](http://store.novellini.com)**





## DATI TECNICI

### FINITURE PROFILI



Bianco  
cod. A



Silver  
cod. B



Cromo   
cod. K



Argento  
cod. J

### VETRO TEMPRATO 3,4,5,6 mm (European Standards EN 14428)



Trasparente   
cod. 1



Niva  
cod. 11



Aqua  
cod. 2



Lunes 2.0  
cod. 78



Maniglia bianca  
o cromata

### SERIGRAFIA

### MANIGLIA

### MISURE DI INGOMBRO PROFILI DI FISSAGGIO

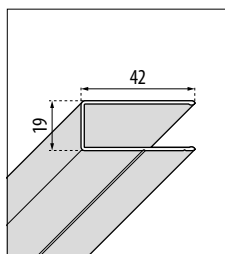

**A MURO**  
R - 2A - 2P - 2PH  
A - AH - 3PH

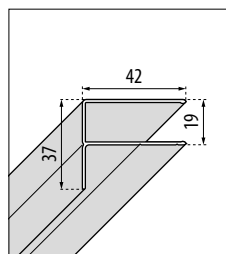

**A MURO**  
G+FL - 3P - S - B - G

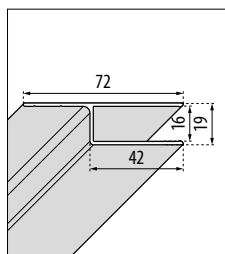

**A MURO**  
profilo a muro laterale  
tutti i modelli

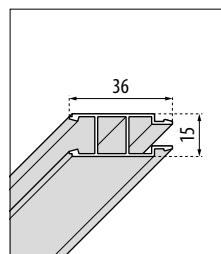

**COMPENSATIVI**  
R - 2A - G+FL + 3P +  
3PH - G - B - S - 2P -  
2PH - A - AH

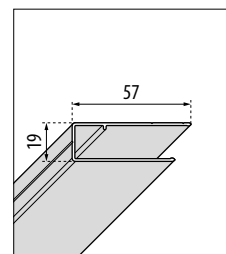

**COMPENSATIVI**  
R - 2A - 2P - 2PH  
A - AH - 3PH

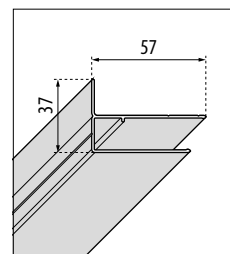

**COMPENSATIVI**  
G+FL - 3P - S - B - G

Finitura	Codice	Finitura	Codice	Finitura	Codice	Finitura	Codice	Finitura	Codice	Finitura	Codice
Bianco	<b>P01BJMOST-A</b>	Bianco	<b>P01BJGBST-A</b>	Bianco	<b>P01L215STL-A</b>	Bianco	<b>P05HAAST3-A</b>	Bianco	<b>P05BHST-A</b>	Bianco	<b>P05BHCST-A</b>
Silver	<b>P01BJMOST-B</b>	Silver	<b>P01BJGBST-B</b>	Silver	<b>P01L215STL-B</b>	Silver	<b>P05HAAST3-B</b>	Silver	<b>P05BHST-B</b>	Silver	<b>P05BHCST-B</b>
Cromo	<b>P01BJMOST-K</b>	Cromo	<b>P01BJGBST-K</b>	Cromo	<b>P01L215STL-K</b>	Cromo	<b>P05HAAST3-K</b>	Cromo	<b>P05BHST-K</b>	Cromo	<b>P05BHCST-K</b>
Argento	<b>P01BJMOST-J</b>	Argento	<b>P01BJGBST-J</b>	Argento	<b>P01L215STL-J</b>	Argento	<b>P05HAAST3-J</b>	Argento	<b>P05BHST-J</b>	Argento	<b>P05BHCST-J</b>

### COME RILEVARE LE MISURE

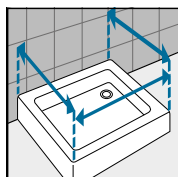
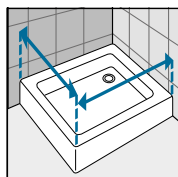

Rilevare le misure da muro a bordo esterno del piatto doccia. Le misure devono essere rilevate sulla parete finita, a rivestimenti posati, secondo gli schemi riportati.

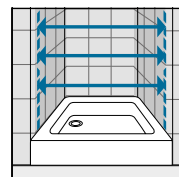

Rilevare le misure da muro a muro, in basso, in alto, al centro e utilizzare quella di valore inferiore. Le misure devono essere rilevate sulla parete finita, a rivestimenti posati, secondo gli schemi riportati.

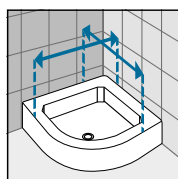

# STAR 2.0

ADATTO A QUALSIASI SOLUZIONE.  
OGGI ANCORA PIÙ ALTO.



DISPONIBILE DA APRILE 2023



◀ Profilo maniglia per evitare ostacoli esterni



◀ **NOVITÀ 2023**  
Altezza 195 cm



◀ La più ampia profondità di gamma del mondo Novellini



Il box doccia versatile nelle soluzioni estetiche. Conformabile a qualsiasi soluzione bagno per le innumerevoli possibilità di installazione, Star diventa protagonista del prendersi cura di sé. L'ampia gamma di finiture permette di adattare il modello ai propri desideri e realizzare un progetto bagno di gusto e funzionalità.



# STAR 2.0

# STAR 2.0 A



## BOX DOCCIA AD ANGOLO APERTURA 2 ANTE SCORREVOLI E 2 FISSE IN LINEA

Misure			Codice	Scelta vetro			Scelta profilo		Scelta acrilico	Scelta profilo	
Misura effettiva d'ingombro	Fisso	Entrata (cm)		1	11	38	A	B	43	A	B
<b>A</b>	<b>F1</b>	*		Trasparente	Niva	Serigrafia punto	Bianco	Silver	Circolare	Bianco	Silver
66↔72	33	35	<b>STA2A66L-</b>				279 €	310 €		260 €	290 €
72↔78	36	39	<b>STA2A72L-</b>				285 €	315 €		265 €	295 €
78↔84	39	43	<b>STA2A78L-</b>				292 €	325 €		270 €	300 €
84↔90	42	48	<b>STA2A84L-</b>	+ 38 €	+ 38 €		298 €	330 €		275 €	305 €
90↔96	45	52	<b>STA2A90L-</b>				320 €	355 €		295 €	325 €
96↔102	48	56	<b>STA2A96L-</b>				348 €	385 €		325 €	360 €
114↔120	57	69	<b>STA2A114L-</b>				369 €	410 €		340 €	375 €
<b>LATI SPECIALI IN ALTEZZA</b>											
H 140↔200			<b>STA2ALSP</b>	+ 38 €	-		462 €	510 €		425 €	470 €

**PER COMPORRE UN ANGOLO ORDINARE 2 LATI  
POSSIBILITA' DI ORDINARE UN PANNELLO FISSO LATERALE PER INSTALLAZIONE A CENTRO PARETE**

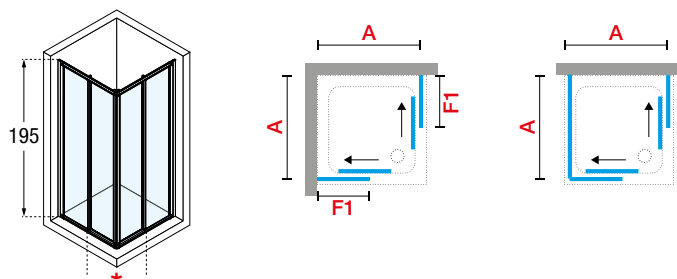



#### FINITURE VETRI



Trasparente  
cod 1



Niva  
cod 11

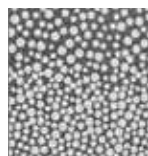

Ser. Punto  
cod 38



Circolare  
cod 43

#### FINITURE PROFILI



Bianco  
cod A



Silver  
cod B

# STAR 2.0 2P



195 cm



3 mm



6 cm



## PORTA DOCCIA, APERTURA 1 ANTA SCORREVOLE E 1 ANTA FISSA IN LINEA, IN NICCHIA

Installabile in nicchia o abbinabile ad 1 o 2 pareti fisse laterali STAR F



### FINITURE VETRI



Trasparente  
cod 1



Niva  
cod 11

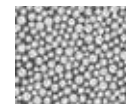

Ser. Punto  
cod 38



Circolare  
cod 43

### FINITURE PROFILI



Bianco  
cod A



Silver  
cod B

Misure			Codice	Scelta vetro			Scelta profilo		Scelta acrilico	Scelta profilo	
Misura effettiva d'ingombro	Fisso	Entrata (cm)		1	11	38	A	B	43	A	B
<b>A</b>	<b>F1</b>	*		Traspa- rente	Niva	Serigrafia punto	Bianco	Silver	Circolare	Bianco	Silver
96↔102	47	39	<b>STA22P96-</b>				502 €	555 €		465 €	515 €
102↔108	50	42	<b>STA22P102-</b>				523 €	580 €		485 €	535 €
108↔114	53	45	<b>STA22P108-</b>				544 €	600 €		505 €	560 €
114↔120	56	48	<b>STA22P114-</b>				564 €	625 €		520 €	575 €
120↔126	59	51	<b>STA22P120-</b>				585 €	645 €		540 €	595 €
126↔132	62	54	<b>STA22P126-</b>				614 €	680 €	+ 38 €	565 €	625 €
132↔138	65	57	<b>STA22P132-</b>				633 €	700 €		585 €	645 €
138↔144	68	60	<b>STA22P138-</b>				655 €	725 €		605 €	670 €
144↔150	71	63	<b>STA22P144-</b>				674 €	745 €		625 €	690 €
150↔156	74	66	<b>STA22P150-</b>				695 €	765 €		640 €	705 €
156↔162	77	69	<b>STA22P156-</b>				717 €	790 €		660 €	730 €
<b>PORTE SPECIALI IN ALTEZZA</b>											
H 140↔200			<b>STA22P2SP</b>	+ 38 €	-		897 €	990 €		825 €	910 €

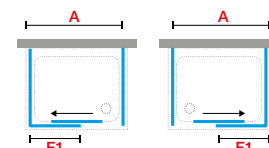
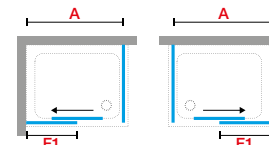
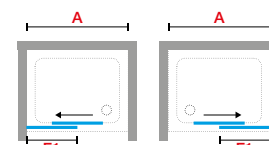
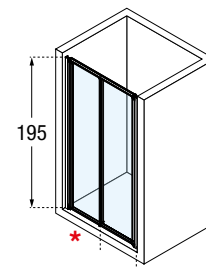

**POSSIBILITA' DI ORDINARE UN PANNELLO FISSO LATERALE PER INSTALLAZIONE A CENTRO PARETE**

# STAR 2.0 R

BOX DOCCIA AD ANGOLO SEMICIRCOLARE, APERTURA 2 ANTE SCORREVOLI E 2 FISSE



195 cm



3 mm



3 cm



STAR 2.0



## FINITURE VETRI



Trasparente  
cod 1



Niva  
cod 11

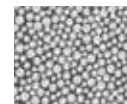

Ser. Punto  
cod 38



Circolare  
cod 43

## FINITURE PROFILI



Bianco  
cod A



Silver  
cod B

Misure			Codice	Scelta vetro			Scelta profilo		Scelta acrilico 43	Scelta profilo	
Misura effettiva d'ingombro	Fisso	Entrata (cm)		1	11	38	A	B		A	B
<b>A</b>	<b>F1</b>	*		Trasparente	Niva	Serigrafia punto	Bianco	Silver	Circolare	Bianco	Silver
78,5↔81,5 x 78,5↔81,5	24	40	<b>STA2R80-</b>				820 €	905 €		755 €	835 €
88,5↔91,5 x 88,5↔91,5	34	54	<b>STA2R90-</b>		+ 76 €	+ 76 €	862 €	950 €		795 €	875 €
98,5↔101,5 x 98,5↔101,5	44	54	<b>STA2R100-</b>				890 €	980 €		820 €	905 €

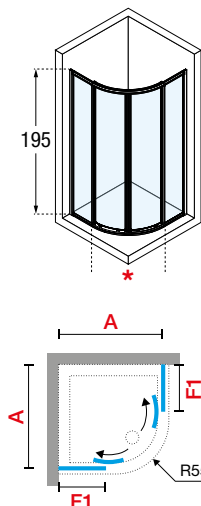

**ANTE SGANCIABILI  
PER FACILITARE LA  
PULIZIA**

Costruzione del codice **Codice** + **Vetro/Acrilico** + **Profilo** = Codice prodotto finale

# STAR 2.0 3P



195 cm



3 mm



6 cm



## PORTA DOCCIA APERTURA 3 ANTE SCORREVOLI BILATERALE DA DESTRA E DA SINISTRA

Installabile in nicchia o abbinabile ad 1 o 2 pareti fisse laterali STAR F



### FINITURE VETRI



Trasparente  
cod 1



Niva  
cod 11

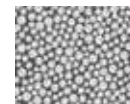

Ser. Punto  
cod 38



Circolare  
cod 43

### FINITURE PROFILI



Bianco  
cod A



Silver  
cod B

Misure		Codice	Scelta vetro			Scelta profilo		Scelta acrilico	Scelta profilo	
Misura effettiva d'ingombro	Entrata (cm)		1	11	38	A	B		43	A
<b>A</b>	*		Trasparente	Niva	Serigrafia punto	Bianco	Silver	Circolare	Bianco	Silver
78↔84	43	<b>STA23P78-</b>				580 €	640 €		535 €	590 €
84↔90	47	<b>STA23P84-</b>				600 €	660 €		555 €	615 €
90↔96	51	<b>STA23P90-</b>				620 €	685 €		575 €	635 €
96↔102	55	<b>STA23P96-</b>		+ 38 €	+ 38 €	640 €	705 €		590 €	650 €
102↔108	59	<b>STA23P102-</b>				680 €	750 €		630 €	695 €
108↔114	63	<b>STA23P108-</b>				710 €	785 €		655 €	725 €
114↔120	67	<b>STA23P114-</b>				740 €	815 €		685 €	755 €
<b>PORTE SPECIALI IN ALTEZZA</b>										
H 140↔200		<b>STA23PSP</b>		+ 38 €	-	910 €	1.005 €		860 €	950 €
L 66↔114										

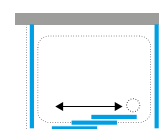
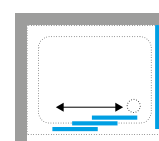
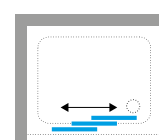
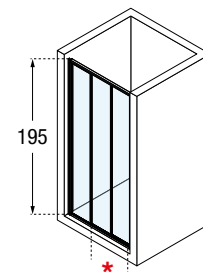

**POSSIBILITA' DI ORDINARE UN PANNELLO FISSO LATERALE PER INSTALLAZIONE A CENTRO PARETE**





# STAR 2.0 G



195 cm



3 mm



6 cm



6 cm



6 cm

## PORTA DOCCIA, APERTURA 1 ANTA BATTENTE

Installabile in nicchia o abbinabile ad 1 o 2 pareti fisse laterali STAR F



### FINITURE VETRI



Trasparente  
cod 1

Niva  
cod 11

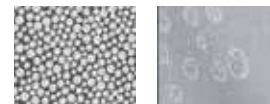

Ser. Punto  
cod 38

Circolare  
cod 43

### FINITURE PROFILI



Bianco  
cod A

Silver  
cod B

Misure			Codice	Scelta vetro			Scelta profilo		Scelta acrilico	Scelta profilo	
Misura effettiva d'ingombro	Entrata (cm)	Ingombro anta esterno		1	11	38	A	B	43	A	B
<b>A</b>	*	<b>B</b>		Trasparente	Niva	Serigrafia punto	Bianco	Silver	Circolare	Bianco	Silver
66↔72	45	45	<b>STA2G66-</b>				357 €	395 €		330 €	365 €
72↔78	51	51	<b>STA2G72-</b>				369 €	410 €		340 €	375 €
78↔84	52	52	<b>STA2G78-</b>	+ 38 €		+ 38 €	385 €	425 €		355 €	395 €
84↔90	58	58	<b>STA2G84-</b>				398 €	440 €		370 €	410 €
<b>PORTE SPECIALI IN ALTEZZA</b>											
H 140↑200		SPECIAL	<b>STA2GSP</b>	+ 38 €	-		498 €	550 €		465 €	515 €

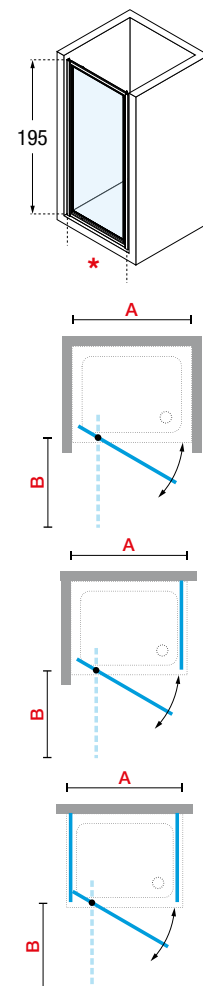

**POSSIBILITA' DI ORDINARE UN PANNELLO FISSO LATERALE PER INSTALLAZIONE A CENTRO PARETE**

Costruzione del codice + Codice + Vetro/Acrilico + Profilo = Codice prodotto finale

# STAR 2.0 B



## PORTA DOCCIA, APERTURA 2 ANTE BATTENTI

Installabile in nicchia o abbinabile ad 1 o 2 pareti fisse laterali STAR F



### FINITURE VETRI



### FINITURE PROFILI

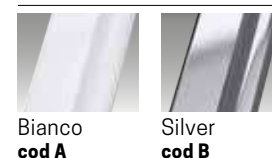

Misure			Codice	Scelta vetro			Scelta profilo		Scelta acrilico	Scelta profilo	
Misura effettiva d'ingombro	Entrata (cm)			1	11	38	A	B	43	A	B
	Vetro	Acrilico	Ingombro anta esterno								
<b>A</b>	*		<b>B</b>	Trasparente	Niva	Serigrafia punto	Bianco	Silver	Circolare	Bianco	Silver
66↔72	49	44	20 22				472 €	520 €		435 €	480 €
72↔78	55	50	23 25				487 €	540 €		450 €	495 €
78↔84	61	56	26 28				502 €	555 €		465 €	515 €
84↔90	67	62	29 31				529 €	585 €		490 €	540 €
90↔96	73	68	32 34				545 €	600 €		505 €	560 €
96↔102	79	74	35 37				573 €	635 €		530 €	585 €

PORTE SPECIALI IN ALTEZZA											
H 140±200			SPECIAL	<b>STA2BSP</b>	+ 38 €	-	717 €	790 €		665 €	735 €

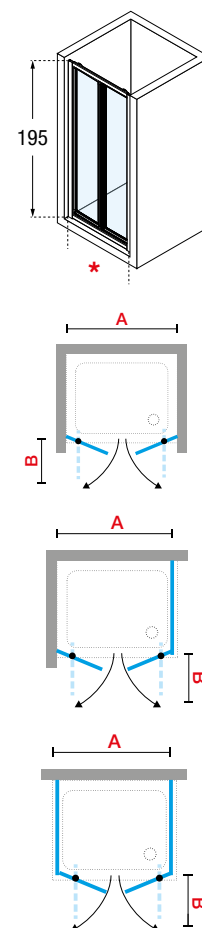

**POSSIBILITA' DI ORDINARE UN PANNELLO FISSO LATERALE PER INSTALLAZIONE A CENTRO PARETE**

# STAR 2.0 S



## PORTA DOCCIA, APERTURA 2 ANTE A SOFFIETTO

Installabile in nicchia o abbinabile ad 1 o 2 pareti fisse laterali STAR F



### FINITURE VETRI



Traspirente  
cod 1

Niva  
cod 11

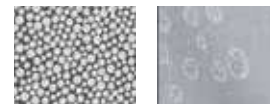

Ser. Punto  
cod 38

Circolare  
cod 43

### FINITURE PROFILI



Bianco  
cod A

Silver  
cod B

Misure			Codice	Scelta vetro			Scelta profilo		Scelta acrilico	Scelta profilo	
Misura effettiva d'ingombro	Entrata (cm)	Ingombro anta esterno		1	11	38	A	B		43	A
<b>A</b>	*	<b>B</b>		Trasparente	Niva	Serigrafia punto	Bianco	Silver	Circolare	Bianco	Silver
66↔72	46	31-29	<b>STA2S66-</b>				502 €	555 €		465 €	515 €
72↔78	52	34-32	<b>STA2S72-</b>				544 €	600 €		505 €	560 €
78↔84	58	37-35	<b>STA2S78-</b>				585 €	645 €		540 €	595 €
84↔90	64	40-38	<b>STA2S84-</b>	+ 38 €	+ 38 €		627 €	690 €		580 €	640 €
90↔96	70	42-40	<b>STA2S90-</b>				655 €	725 €		605 €	670 €
96↔102	76	45-43	<b>STA2S96-</b>				683 €	755 €		630 €	695 €

### PORTE SPECIALI IN ALTEZZA

H 140↔200	SPECIAL	<b>STA2SSP</b>	+ 38 €	-	854 €	940 €	745 €	820 €
-----------	---------	----------------	--------	---	-------	-------	-------	-------

**POSSIBILITA' DI ORDINARE UN PANNELLO FISSO LATERALE PER INSTALLAZIONE A CENTRO PARETE**



**APERTURA DI SICUREZZA. ATTENZIONE: L'APERTURA VERSO L'ESTERNO DEVE ESSERE CONSIDERATA SOLAMENTE COME APERTURA D'EMERGENZA**

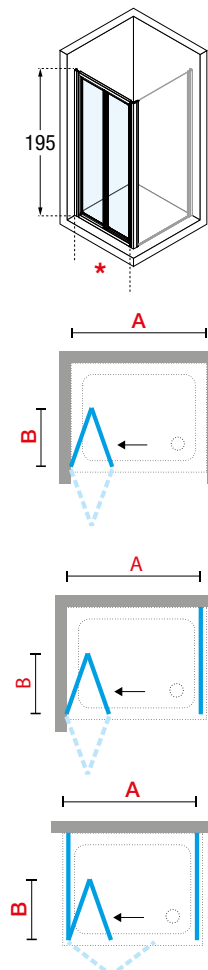

Costruzione del codice + Codice + Vetro/Acrilico + Profilo = Codice prodotto finale

# STAR 2.0 F

PARETE FISSA LATERALE



195 cm



4 mm  
Vetro



3 mm  
acrilico



6 cm



## FINITURE VETRI



Trasparente  
cod 1



Niva  
cod 11

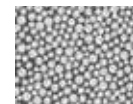

Ser. Punto  
cod 38



Circolare  
cod 43

## FINITURE PROFILI



Bianco  
cod A



Silver  
cod B

Misure	Codice	Scelta vetro			Scelta profilo		Scelta acrilico	Scelta profilo	
		1	11	38	A	B	43	A	B
<b>Misura effettiva d'ingombro</b>									
<b>F</b>		Trasparente	Niva	Serigrafia punto	Bianco	Silver	Circolare	Bianco	Silver
66↔72	<b>STA2F66-</b>				265 €	295 €		245 €	270 €
72↔78	<b>STA2F72-</b>				280 €	310 €		260 €	290 €
78↔84	<b>STA2F78-</b>				294 €	325 €		275 €	305 €
84↔90	<b>STA2F84-</b>		+ 38 €	+ 38 €	308 €	340 €		285 €	315 €
90↔96	<b>STA2F90-</b>				336 €	370 €		310 €	345 €
96↔102	<b>STA2F96-</b>				364 €	405 €		335 €	370 €

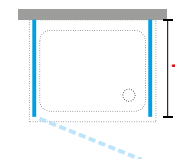
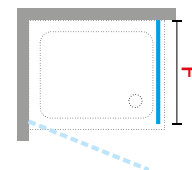
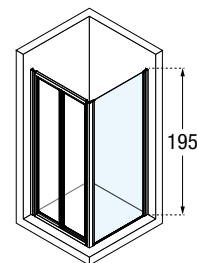

**PARETE FISSA IN ACRILICO COMPLETA DI PROFILI SUPERIORE E INFERIORE. PER SOLUZIONI CON 2 PANNELLI FISSI LATERALI, UTILIZZARE SEMPRE 2 BARRE DI SOSTEGNO AD ANGOLO.**



# STAR 2.0 SOLO PROFILI

ALTEZZA 1950 mm



6 cm



## FINITURE PROFILI



Bianco  
cod A

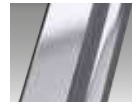

Silver  
cod B

Misure	Codice	Scelta profilo	
		A	B
Misura effettiva d'ingombro		Bianco	Silver
<b>A FISSAGGIO FRONTALE</b>			
4↔6,7	<b>STA2F46ST-</b>	87 €	100 €
6,8↔9,1	<b>STA2F69ST-</b>	124 €	144 €
9,2↔11,4	<b>STA2F911ST-</b>	138 €	155 €
11,5↔16	<b>STA2F1116ST-</b>	149 €	167 €
16,1↔20	<b>STA2F1620ST-</b>	167 €	186 €
<b>B FISSAGGIO LATERALE</b>			
4↔6,7	<b>STA2F46STL-</b>	112 €	124 €
6,8↔9,1	<b>STA2F69STL-</b>	155 €	175 €
9,2↔11,4	<b>STA2F911STL-</b>	162 €	181 €
11,5↔16	<b>STA2F1116STL-</b>	181 €	199 €
16,1↔20	<b>STA2F1620STL-</b>	193 €	211 €

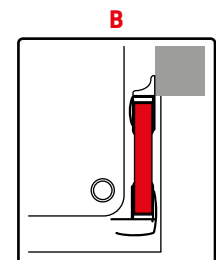
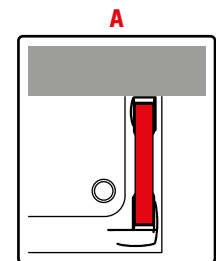
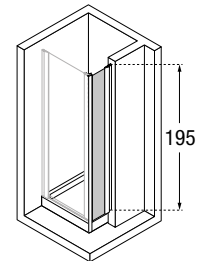

Costruzione del codice **Codice** + **Profilo** = Codice prodotto finale

# STAR 2.0 F SPECIAL 1



## PARETE FISSA SPECIALE, SPECIALE IN LARGHEZZA

Abbinabile a STAR A, 3A, B, G, P, 2P, S, 2S



### FINITURE VETRI



Trasparente  
cod 1



Niva  
cod 11



Circolare  
cod 43

### FINITURE PROFILI



Bianco  
cod A



Silver  
cod B

Misure	Codice	Scelta vetro		Scelta profilo		Scelta acrilico	Scelta profilo	
		1	11	A	B	43	A	B
L 20↔65,9	<b>STA2F1SP</b>	Trasparente	Niva	Bianco	Silver	Circolare	Bianco	Silver
L 66↔89,9	<b>STA2F1SP</b>		+ 38 €	414 €	460 €		385 €	425 €
L 90↔96	<b>STA2F1SP</b>			480 €	530 €		445 €	490 €
H 80↔200				513 €	565 €		475 €	525 €

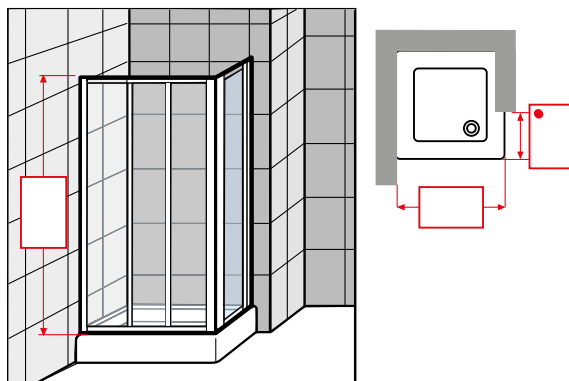
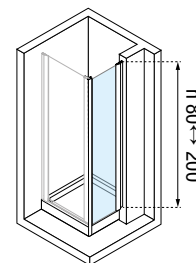

**FORNITO SENZA PROFILO DI FISSAGGIO A MURO**

**PER LA FATTIBILITÀ DELLE MISURE SPECIALI CONTATTARE IL SERVIZIO CLIENTI O CONSULTARE [HTTP://STORE.NOVELLINI.COM](http://store.novellini.com)**

**FISSI SPECIALI IN LARGHEZZA. ALTEZZA DA 80 A 200 CM (SPECIFICARE MISURA ESATTA NELL'ORDINE)**



# STAR 2.0 F SPECIAL 2



195 cm



4 mm  
Vetro



3 mm  
acrilico



## PARETE FISSA SPECIALE, SAGOMATA 5 LATI

Abbinabile a STAR A, 3A, B, G, P, 2P, S, 2S



### FINITURE VETRI



Trasparente  
cod 1



Niva  
cod 11



Circolare  
cod 43

### FINITURE PROFILI



Bianco  
cod A



Silver  
cod B

Misure	Codice	Scelta vetro		Scelta profilo		Scelta acrilico	Scelta profilo	
		1 Trasparente	11 Niva	A Bianco	B Silver	43 Circolare	A Bianco	B Silver
L 30↔65,9	<b>STA2F2SP</b>			578 €	640 €		535 €	590 €
L 66↔89,9	<b>STA2F2SP</b>		+ 38 €	607 €	670 €		560 €	620 €
L 90↔102	<b>STA2F2SP</b>			623 €	690 €		575 €	635 €

H 90†200

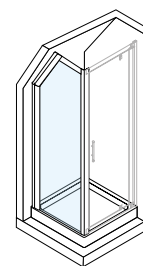

**S** Sinistra

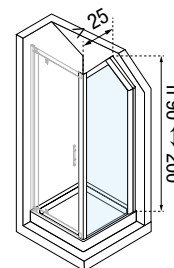

**D** Destra

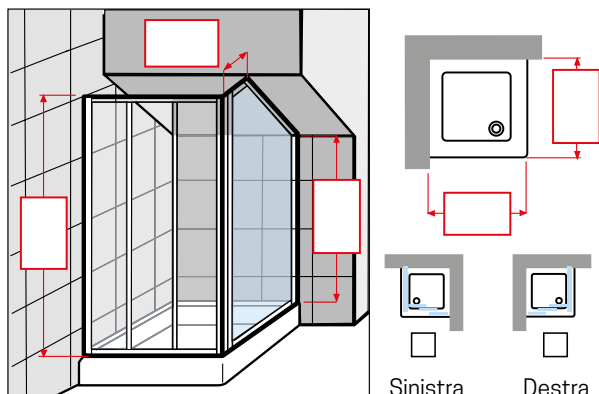

**FISSI SPECIALI IN LARGHEZZA. ALTEZZA DA 90 A 200 CM (SPECIFICARE MISURA ESATTA NELL'ORDINE)**

**PER LA FATTIBILITÀ DELLE MISURE SPECIALI CONTATTARE IL SERVIZIO CLIENTI O CONSULTARE [HTTP://STORE.NOVELLINI.COM](http://store.novellini.com)**

Costruzione del codice    **Codice** + **Vetro/Acrilico** + **Profilo** = Codice prodotto finale

# STAR 2.0 F SPECIAL 3

PARETE FISSA SPECIALE, SAGOMATA 6 LATI



## FINITURE VETRI



Trasparente  
cod 1



Niva  
cod 11



Circolare  
cod 43

## FINITURE PROFILI



Bianco  
cod A



Silver  
cod B

Misure	Codice	Scelta vetro		Scelta profilo		Scelta acrilico	Scelta profilo	
		1	11	A	B	43	A	B
		Trasparente	Niva	Bianco	Silver	Circolare	Bianco	Silver
L 45↔65,9	<b>STA2F3SP</b>			578 €	640 €		535 €	590 €
L 66↔89,9	<b>STA2F3SP</b>		+ 38 €	607 €	670 €		560 €	620 €
L 90↔102	<b>STA2F3SP</b>			622 €	685 €		575 €	635 €

H 100↔200

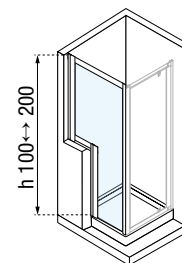

**S** Sinistra

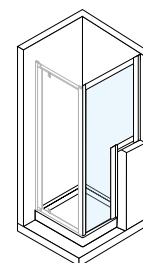

**D** Destra

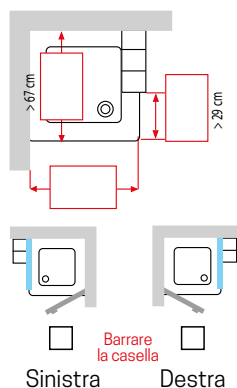
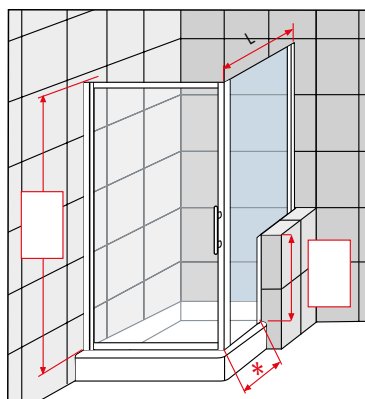

\*  $\geq L/3$ : LA QUOTA DI \* DEVE ESSERE MAGGIORE DI 1/3 DELLA LUCE SUPERIORE E COMUNQUE NON INFERIORE A 20 cm.

**FISSI SPECIALI IN LARGHEZZA. ALTEZZA DA 100 A 200 CM (SPECIFICARE MISURA ESATTA NELL'ORDINE)  
PER LA FATTIBILITÀ DELLE MISURE SPECIALI CONTATTARE IL SERVIZIO CLIENTI O CONSULTARE [HTTP://STORE.NOVELLINI.COM](http://store.novellini.com)**



# STAR 2.0 F SPECIAL 4



4 mm  
Vetro



3 mm  
acrilico



6 cm



**PARETE FISSA SPECIALE, PER INSTALLAZIONE SU MURETTO, SPECIALE IN LARGHEZZA ED ALTEZZA**

Abbinabile a STAR A, 3A, B, G, P, 2P, S, 2S



## FINITURE VETRI



Trasparente  
cod 1



Niva  
cod 11



Circolare  
cod 43

## FINITURE PROFILI



Bianco  
cod A



Silver  
cod B

Misure	Codice	Scelta vetro		Scelta profilo		Scelta acrilico	Scelta profilo	
		1	11	A	B		43	A
L 30↔65,9	<b>STA2F4SP</b>	Trasparente	Niva	Bianco	Silver	Circolare	Bianco	Silver
L 66↔89,9	<b>STA2F4SP</b>		+ 38 €	428 €	475 €		395 €	435 €
L 90↔102	<b>STA2F4SP</b>			480 €	530 €		445 €	490 €
				487 €	540 €		450 €	495 €

H 60↔195

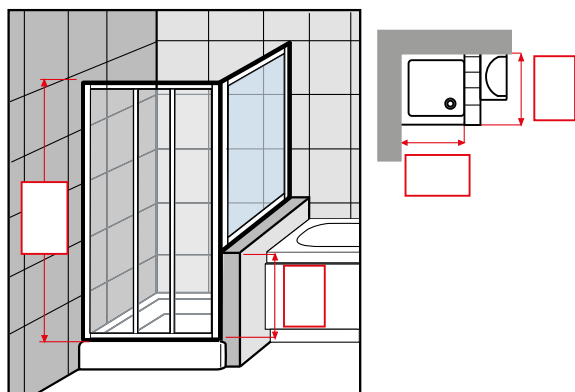
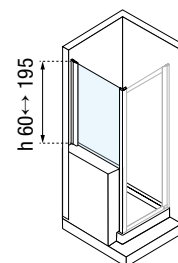

**FISSI SPECIALI IN LARGHEZZA. ALTEZZA DA 60 A 185 CM (SPECIFICARE MISURA ESATTA NELL'ORDINE)  
PER LA FATTIBILITÀ DELLE MISURE SPECIALI CONTATTARE IL SERVIZIO CLIENTI O CONSULTARE [HTTP://STORE.NOVELLINI.COM](http://store.novellini.com)**

Costruzione del codice    **Codice** + **Vetro/Acrilico** + **Profilo** = Codice prodotto finale

# STAR 2.0 F SPECIAL 5

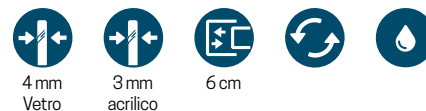

**PARETE FISSA SPECIALE, IN LINEA / PARETE DIVISORIA / FISSAGGIO A MURO LATERALE / PROFILO CHIUSO**



**FISSAGGIO IN LINEA**



**PARETE DIVISORIA**



**FISSAGGIO A MURO LATERALE**



**PROFILO CHIUSO**

## FISSAGGIO IN LINEA

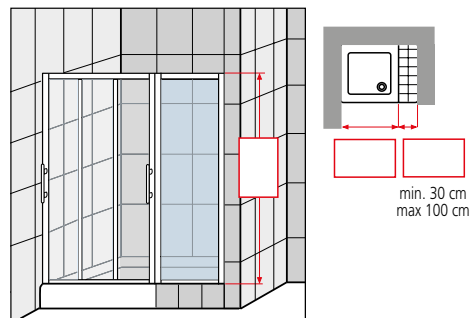

## PARETE DIVISORIA

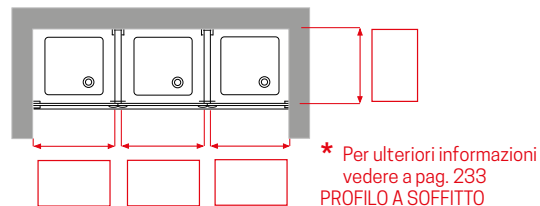
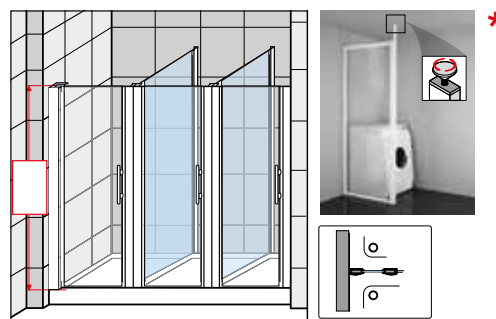

## FISSAGGIO A MURO LATERALE

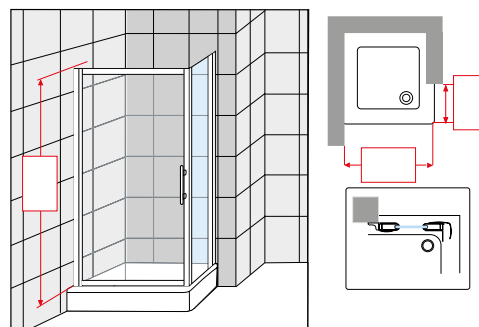

## PROFILO CHIUSO

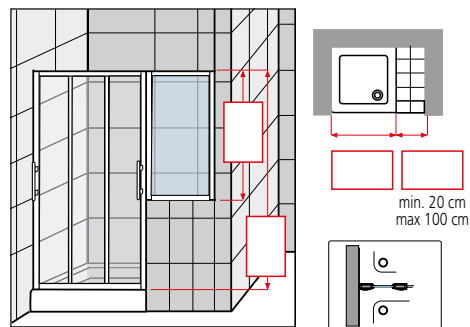

Misure	Codice	Scelta vetro		Scelta profilo		Scelta acrilico	Scelta profilo	
		1	11	A	B		A	B
		Trasparente	Niva	Bianco	Silver	Circolare	Bianco	Silver

FISSI IN LINEA E PROFILI CHIUSI								
H 25	59,9	<b>STA2F5SP</b>		385 €	425 €		355 €	395 €
H 60	95,9	<b>STA2F5SP</b>		437 €	485 €		405 €	450 €
H 96	159,9	<b>STA2F5SP</b>	+ 38 €	464 €	515 €		430 €	475 €
H 160	189,9	<b>STA2F5SP</b>		493 €	545 €		455 €	505 €
H 190	200	<b>STA2F5SP</b>		530 €	585 €		490 €	540 €

PARETE DIVISORIA								
H 25	59,9	<b>STA2F5SP</b>		414 €	460 €		385 €	425 €
H 60	95,9	<b>STA2F5SP</b>		464 €	515 €		430 €	475 €
H 96	159,9	<b>STA2F5SP</b>	+ 38 €	493 €	545 €		455 €	505 €
H 160	189,9	<b>STA2F5SP</b>		530 €	585 €		490 €	540 €
H 190	200	<b>STA2F5SP</b>		557 €	615 €		515 €	570 €

FISSAGGIO LATERALE (DIS B.)								
H 25	59,9	<b>STA2F5SP</b>		443 €	490 €		410 €	455 €
H 60	95,9	<b>STA2F5SP</b>		493 €	545 €		455 €	505 €
H 96	159,9	<b>STA2F5SP</b>	+ 38 €	530 €	585 €		490 €	540 €
H 160	189,9	<b>STA2F5SP</b>		557 €	615 €		515 €	570 €
H 190	200	<b>STA2F5SP</b>		592 €	655 €		545 €	600 €

**FISSI SPECIALI IN ALTEZZA. LARGHEZZA DA 20 A 100 CM (SPECIFICARE MISURA ESATTA NELL'ORDINE) PER LA FATTIBILITÀ DELLE MISURE SPECIALI CONTATTARE IL SERVIZIO CLIENTI O CONSULTARE [HTTP://STORE.NOVELLINI.COM](http://store.novellini.com)**



## DATI TECNICI

### FINITURE PROFILI



Bianco  
cod. A



Silver  
cod. B

### VETRO TEMPRATO 3, 4, 5 mm (European Standards EN 14428)



Trasparente  
cod. 1



Niva  
cod. 11

### SERIGRAFIA

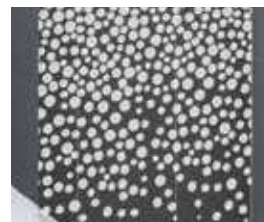

Punto  
cod. 38

### ACRILICO 3 mm



Circolare  
cod. 43

### OPTIONAL

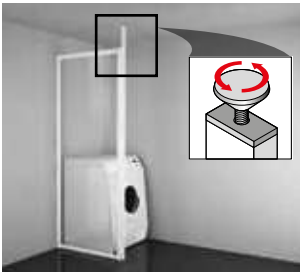

**PROFILO A SOFFITTO**

- Profilo speciale per fissaggio a soffitto da abbinare allo NSTARF5SP

Finitura	Misure	Codice	Prezzo
Bianco	H 180 ↓ 265	<b>SPA3102</b>	115 €
Silver	H 180 ↓ 265	<b>SPA3102</b>	128 €

### MISURE DI INGOMBRO PROFILI DI FISSAGGIO

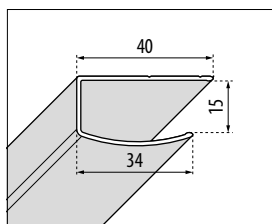

**A MURO**  
A - R - F

Finitura	Codice
Bianco	<b>P01HAAST3-A</b>
Silver	<b>P01HAAST3-B</b>

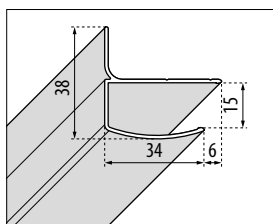

**A MURO**  
2P - 3P - G - B - S

Finitura	Codice
Bianco	<b>P01HAPCST3-A</b>
Silver	<b>P01HAPCST3-B</b>

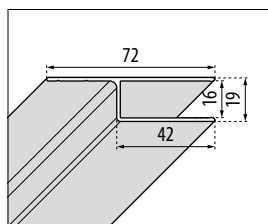

**A MURO**  
profilo a muro laterale  
tutti i modelli

Finitura	Codice
Bianco	<b>P01L215STL-A</b>
Silver	<b>P01L215STL-B</b>

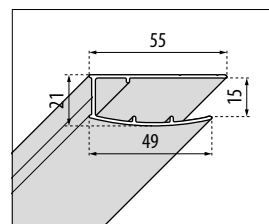

**COMPENSAZIONE**  
tutti i modelli

Finitura	Codice
Bianco	<b>P01SACST3-A</b>
Silver	<b>P01SACST3-B</b>

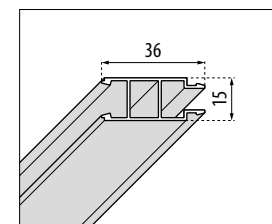

**COMPENSAZIONE**  
per modello A

Finitura	Codice
Bianco	<b>P05HAAST3-A</b>
Silver	<b>P05HAAST3-B</b>

### COME RILEVARE LE MISURE

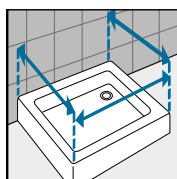
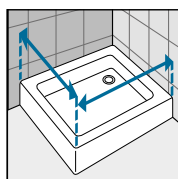

Rilevare le misure da muro a bordo esterno del piatto doccia. Le misure devono essere rilevate sulla parete finita, a rivestimenti posati, secondo gli schemi riportati.

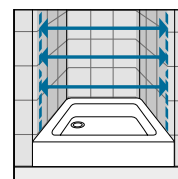
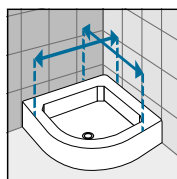

Rilevare le misure da muro a muro, in basso, in alto, al centro e utilizzare quella di valore inferiore. Le misure devono essere rilevate sulla parete finita, a rivestimenti posati, secondo gli schemi riportati.

# FREE

FUNZIONALE  
ALLE ESIGENZE DI TUTTI



◀ Sistema di apertura  
separato delle ante (Free 1)



◀ La soluzione per una grande  
libertà di movimento



◀ Cerniere in metallo cromato  
con sollevamento dell'anta



Free è il box doccia ampio, con sostegni e aiuti che soddisfano le esigenze di mobilità limitata, in un modello di qualità e design ricercati. Facile per chi lo usa e per chi fornisce assistenza grazie all'ingresso sdoppiato, spazi ampi per facilitare i movimenti e accorgimenti che appagano il desiderio di sicurezza e praticità.

## TRATTAMENTI





**FREE**

# FREE 1 2G

BOX DOCCIA AD ANGOLO APERTURA 2 ANTE BATTENTI DIVISE IN DUE METÀ



195 cm



6 mm



3 cm



Non reversibile asimmetrico



## FINITURE VETRI



Trasparente  
cod 1

## FINITURE PROFILI



Bianco  
cod A



Silver  
cod B



Cromo  
cod K

Dimensioni			Codice	Destra	Sinistra	Scelta vetro	Scelta profilo		
Misura effettiva d'ingombro	Entrata (cm)	Ingombro anta esterno		D-	S-	1	A	B	K
A	*	B				Trasparente	Bianco	Silver	Cromo
<b>VERSIONE SIMMETRICA (ANGOLO COMPLETO)</b>									
77↔80	95	68	<b>FREE2G80-</b>				1.510 €	1.694 €	1.864 €
87↔90	110	78	<b>FREE2G90-</b>	-	-		1.586 €	1.776 €	1.956 €
100↔103	128	91	<b>FREE2G100-</b>				1.726 €	1.934 €	2.128 €
<b>VERSIONE ASIMMETRICA FREE</b>									
77↔80	-	68	<b>FREE2G80L</b>	D-	S-		755 €	847 €	932 €
87↔90	-	78	<b>FREE2G90L</b>	D-	S-		793 €	888 €	978 €
100↔103	-	91	<b>FREE2G100L</b>	D-	S-		863 €	967 €	1.064 €
L 76,5↔99,5		SPECIAL	<b>FREEGSP</b>	-	-		983 €	1.102 €	1.213 €

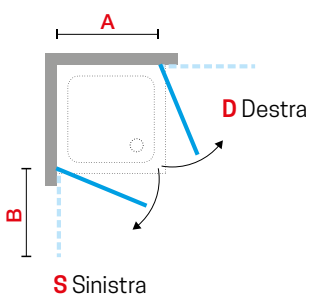
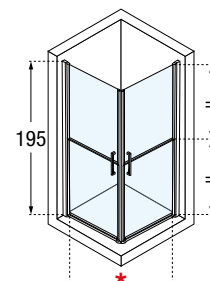

**PER COMPORRE UN ANGOLO ASIMMETRICO, ORDINARE 2 LATI (LATO DESTRO + LATO SINISTRO)**

# FREE 1 G+F IN LINEA



## PORTA DOCCIA APERTURA 1 ANTA BATTENTE DIVISA IN DUE METÀ E 1 FISSO IN LINEA

Installabile in nicchia o abbinabile a 1 parete fissa laterale FREE 1 FGF



### FINITURE VETRI



Trasparente  
cod 1

### FINITURE PROFILI



Bianco  
cod A



Silver  
cod B



Cromo  
cod K

Dimensioni					Codice	Destra	Sinistra	Scelta vetro	Scelta profilo		
Misura effettiva d'ingombro		Entrata (cm)	Ingombro anta esterno	A1					A	B	K
con fisso	In nicchia				F1	*	B	1			
								Trasparente	Bianco	Silver	Cromo
<b>PORTA</b>											
112,5↔118,5	110↔116	35	67	68	<b>FREEGF110</b>	D-	S-		1.137 €	1.263 €	1.389 €
118,5↔124,5	116↔122	18	90	91	<b>FREEGF120</b>	D-	S-		1.207 €	1.342 €	1.477 €
138,5↔144,5	136↔142	38	90	91	<b>FREEGF140</b>	D-	S-		1.352 €	1.502 €	1.652 €
168,5↔174,5	166↔172	68	90	91	<b>FREEGF170</b>	D-	S-		1.509 €	1.675 €	1.844 €
<b>PARETE FISSA</b>											
<b>F</b>											
77↔80	-	-	-	-	<b>FREEFGF80-</b>				663 €	735 €	809 €
87↔90	-	-	-	-	<b>FREEFGF90-</b>				705 €	784 €	863 €
104↔107	-	-	-	-	<b>FREEFGF100-</b>				749 €	832 €	915 €
124↔127	-	-	-	-	<b>FREEFGF120-</b>				793 €	880 €	968 €
L 40↔125			SPECIAL		<b>FREEFGFSP</b>	-	-		888 €	985 €	1.085 €

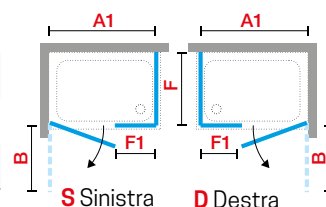
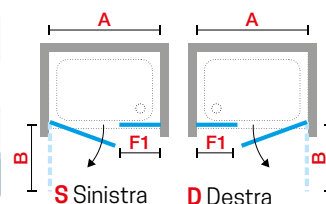
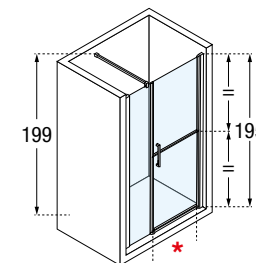

# FREE 1 G+F



195 cm



6 mm



3 cm fisso



3 cm Porta



**BOX DOCCIA AD ANGOLO APERTURA 1 ANTA BATTENTE DIVISA IN DUE METÀ E 1 FISSA IN LINEA CON 1 PARETE FISSA LATERALE**



## FINITURE VETRI



Trasparente  
cod 1

## FINITURE PROFILI



Bianco  
cod A



Silver  
cod B



Cromo  
cod K

Dimensioni			Codice	Destra	Sinistra	Scelta vetro	Scelta profilo		
Misura effettiva d'ingombro	Entrata (cm)	Ingombro anta esterno					D-	S-	1
A	*	B				Trasparente	Bianco	Silver	Cromo
<b>PORTA</b>									
77↔80	67	68	<b>FREE2G80L</b>	D-	S-		755 €	847 €	932 €
87↔90	77	78	<b>FREE2G90L</b>	D-	S-		793 €	888 €	978 €
100↔103	90	91	<b>FREE2G100L</b>	D-	S-		863 €	967 €	1.064 €
L 76,5↔99,5		SPECIAL	<b>FREEGSP</b>	-	-		983 €	1.102 €	1.213 €
<b>PARETE FISSA</b>									
<b>F</b>									
78↔81	-	-	<b>FREEF2G80</b>	D-	S-		663 €	743 €	818 €
88↔91	-	-	<b>FREEF2G90</b>	D-	S-		705 €	792 €	872 €
104↔107	-	-	<b>FREEF2G100</b>	D-	S-		749 €	839 €	924 €
L 60,5↔103,5		SPECIAL	<b>FREEF2GSP</b>	-	-		888 €	995 €	1.095 €

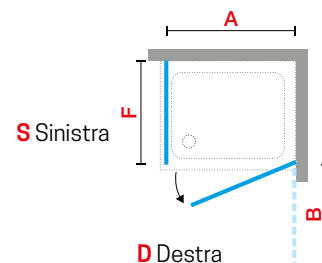
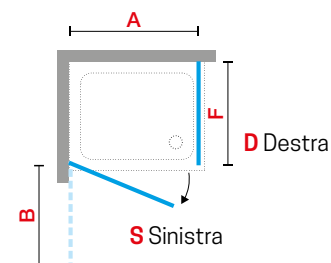
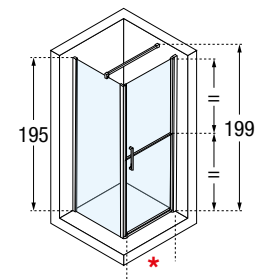



# FREE 1 1B



## PORTA DOCCIA APERTURA 1 ANTA BATTENTE DIVISA IN DUE METÀ

Installabile in nicchia o abbinabile a 1 parete fissa laterale FREE 1 FGF



### FINITURE VETRI



Trasparente  
cod 1

### FINITURE PROFILI



Bianco  
cod A



Silver  
cod B



Cromo  
cod K

Dimensioni				Codice	Scelta vetro	Scelta profilo		
Misura effettiva d'ingombro		Entrata (cm)	Ingombro anta esterno			1	A	B
con fisso	In nicchia			*	B	Trasparente	Bianco	Silver
<b>A</b>	<b>A1</b>							

#### PORTA

78,5↔84,5	76↔82	63	64	<b>FREE1B80-</b>	950 €	1.064 €	1.170 €
88,5↔94,5	86↔92	73	74	<b>FREE1B90-</b>	992 €	1.112 €	1.223 €
106↔112	104↔110	91	92	<b>FREE1B100-</b>	1.035 €	1.160 €	1.277 €

#### PARETE FISSA

F				Codice	Scelta profilo		
Entrata (cm)	In nicchia	Ingombro anta esterno	1		A	B	K
77↔80	-	-	-	<b>FREEFGF80-</b>	663 €	735 €	809 €
87↔90	-	-	-	<b>FREEFGF90-</b>	705 €	784 €	863 €
104↔107	-	-	-	<b>FREEFGF100-</b>	749 €	832 €	915 €
124↔127	-	-	-	<b>FREEFGF120-</b>	793 €	880 €	968 €
L 40↔125			SPECIAL	<b>FREEFGFSP</b>	888 €	985 €	1.085 €

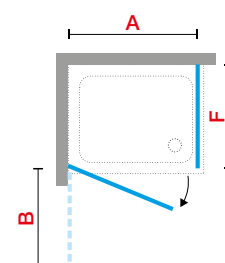
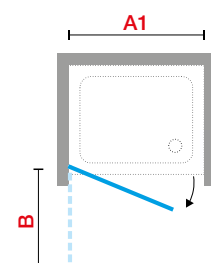
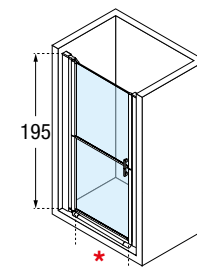

Costruzione del codice **Codice** + **Vetro** + **Profilo** = Codice prodotto finale

# FREE 1 2B



## PORTA DOCCIA, APERTURA 2 ANTE BATTENTI DIVISE IN DUE METÀ

Installabile in nicchia o abbinabile a 1 parete fissa laterale FREE 1 F2B



### FINITURE VETRI



### FINITURE PROFILI



Dimensioni				Codice	Scelta vetro	Scelta profilo		
Misura effettiva d'ingombro		Entrata (cm)	Ingombro anta esterno			1	A	B
con fisso	In nicchia			*	B	Trasparente	Bianco	Silver

PORTA							
78,5↔84,5	76↔82	61	30	<b>FREE2B80-</b>	1.193 €	1.335 €	1.469 €
88,5↔94,5	86↔92	71	35	<b>FREE2B90-</b>	1.267 €	1.418 €	1.560 €
98,5↔104,5	96↔102	81	40	<b>FREE2B100-</b>	1.335 €	1.497 €	1.647 €
118,5↔124,5	116↔122	101	50	<b>FREE2B120-</b>	1.409 €	1.579 €	1.738 €

PARETE FISSA							
<b>F</b>							
77,5↔80,5	-	-	-	<b>FREEF2B80-</b>	663 €	735 €	809 €
87,5↔90,5	-	-	-	<b>FREEF2B90-</b>	705 €	784 €	863 €
104↔107	-	-	-	<b>FREEF2B100-</b>	749 €	832 €	915 €
124↔127	-	-	-	<b>FREEF2B120-</b>	793 €	880 €	968 €

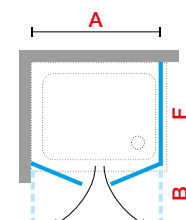
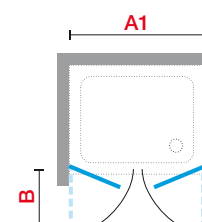
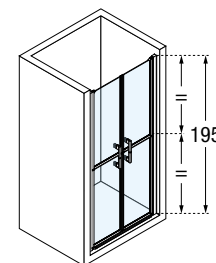

# FREE 1 A



195 cm



6 mm



3 cm



BOX DOCCIA AD ANGOLO APERTURA 2 ANTE BATTENTI DIVISE IN DUE METÀ E 2 FISSE IN LINEA



## FINITURE VETRI



Trasparente  
cod 1

## FINITURE PROFILI



Bianco  
cod A



Silver  
cod B



Cromo  
cod K

Dimensioni				Codice	Scelta vetro	Scelta profilo		
Misura effettiva d'ingombro	Fisso frontale	Entrata (cm)	Ingombro anta esterno			1	A	B
<b>A</b>	<b>F1</b>	*	<b>B</b>		Trasparente	Bianco	Silver	Cromo
<b>VERSIONE SIMMETRICA (ANGOLO COMPLETO)</b>								
124↔127	29	127	92	<b>FREEA120-</b>		1.870 €	2.096 €	2.306 €
154↔157	59	127	92	<b>FREEA150-</b>		2.014 €	2.254 €	2.480 €
<b>VERSIONE ASIMMETRICA FREE (LATI)</b>								
124↔127	29	-	92	<b>FREEA120L-</b>		935 €	1.048 €	1.153 €
154↔157	59	-	92	<b>FREEA150L-</b>		1.007 €	1.127 €	1.240 €

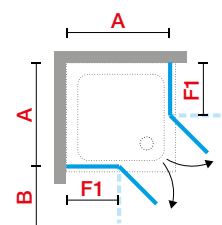
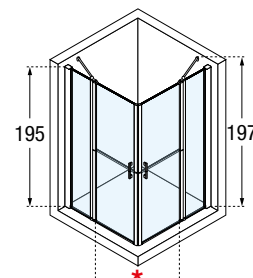

PER COMPORRE UN ANGOLO ASIMMETRICO, ORDINARE 2 LATI

Costruzione del codice **Codice** + **Vetro** + **Profilo** = Codice prodotto finale

# FREE 2 A VERSIONE ALTA



**BOX DOCCIA AD ANGOLO, APERTURA 2 ANTE A SOFFIETTO RIPIEGABILI ALL'INTERNO**

Versione alta - 190 cm



## FINITURE VETRI



## FINITURE PROFILI

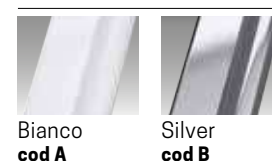

Dimensioni			Codice	Scelta vetro		Scelta profilo		Acrilico	Scelta profilo	
Misura effettiva d'ingombro	Ingombro anta esterno			1	11	A	B		43	A
<b>A</b>	<b>B</b>	<b>B1</b>		Trasparente	Niva	Bianco	Silver	Circolare	Bianco	Silver
64,5↔67,5	59	30	<b>FREE2A66AL-</b>	●	+ 38 €	399 €	452 €		348 €	398 €
67,5↔70,5	62	32	<b>FREE2A69AL-</b>			407 €	460 €	354 €	404 €	
70,5↔73,5	65	33	<b>FREE2A72AL-</b>			413 €	467 €	362 €	412 €	
73,5↔76,5	68	35	<b>FREE2A75AL-</b>			423 €	478 €	368 €	420 €	
76,5↔79,5	71	36	<b>FREE2A78AL-</b>			432 €	488 €	377 €	430 €	
79,5↔82,5	74	38	<b>FREE2A81AL-</b>			438 €	495 €	382 €	435 €	
82,5↔85,5	77	39	<b>FREE2A84AL-</b>			438 €	495 €	382 €	435 €	
85,5↔88,5	80	41	<b>FREE2A87AL-</b>			445 €	504 €	389 €	444 €	
H 85↔190 L 59,5↔98	SPECIAL		<b>FREE2AALSP</b>	+ 38 €	507 €	574 €	442 €	503 €		

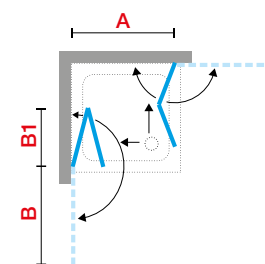
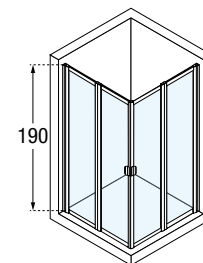

## OPTIONAL

PROFILO DI TENUTA INFERIORE		
Finitura	Codice	Prezzo
Bianco	<b>R55FR2A-A</b>	82 €
Silver	<b>R55FR2A-B</b>	82 €
Cromo	<b>R55FR2A-K</b>	92 €

**PER COMPORRE UN ANGOLO ORDINARE 2 LATI**



# FREE 2 A VERSIONE BASSA



85 cm



3 mm



3 cm



## BOX DOCCIA AD ANGOLO, APERTURA 2 ANTE A SOFFIETTO RIPIEGABILI ALL'INTERNO

Versione bassa - 85 cm



### FINITURE VETRI



Trasparente  
cod 1



Niva  
cod 11



Circolare  
cod 43

### FINITURE PROFILI



Bianco  
cod A



Silver  
cod B

Dimensioni			Codice	Scelta vetro		Scelta profilo		Acrilico	Scelta profilo	
Misura effettiva d'ingombro	Ingombro anta esterno			1	11	A	B		43	A
<b>A</b>	<b>B</b>	<b>B1</b>		Trasparente	Niva	Bianco	Silver	Circolare	Bianco	Silver
64,5↔67,5	59	30	<b>FREE2A66BL-</b>			345 €	390 €		314 €	358 €
67,5↔70,5	62	32	<b>FREE2A69BL-</b>			352 €	399 €		322 €	367 €
70,5↔73,5	65	33	<b>FREE2A72BL-</b>			359 €	407 €		328 €	375 €
73,5↔76,5	68	35	<b>FREE2A75BL-</b>			368 €	417 €		337 €	384 €
76,5↔79,5	71	36	<b>FREE2A78BL-</b>			375 €	425 €		342 €	390 €
79,5↔82,5	74	38	<b>FREE2A81BL-</b>			384 €	435 €		350 €	400 €
82,5↔85,5	77	39	<b>FREE2A84BL-</b>			384 €	435 €		350 €	400 €
85,5↔88,5	80	41	<b>FREE2A87BL-</b>			392 €	442 €		357 €	408 €
H 85↔190 L 59,5↔98	SPECIAL		<b>FREE2AALSP</b>		+ 38 €	507 €	574 €		442 €	503 €

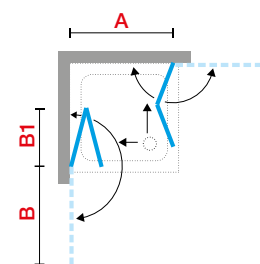
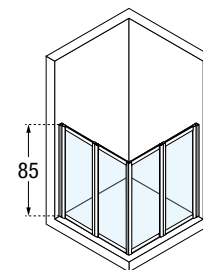

### OPTIONAL

PROFILO DI TENUTA INFERIORE		
Finitura	Codice	Prezzo
Bianco	<b>R55FR2A-A</b>	82 €
Silver	<b>R55FR2A-B</b>	82 €
Cromo	<b>R55FR2A-K</b>	92 €

### PER COMporre UN ANGOLO ORDINARE 2 LATI

Costruzione del codice + Codice + Vetro/Acrilico + Profilo = Codice prodotto finale

# FREE 2 P VERSIONE ALTA



**PORTA DOCCIA APERTURA 2 ANTE A SOFFIETTO INSTALLABILE SOLO IN NICCHIA**

Versione alta - 190 cm



## FINITURE VETRI



Trasparente  
cod 1

Niva  
cod 11



Circolare  
cod 43

## FINITURE PROFILI



Bianco  
cod A

Silver  
cod B

Dimensioni				Entrata	Codice	Scelta vetro		Scelta profilo		Acrilico	Scelta profilo	
Misura effettiva d'ingombro	Ingombro anta esterno					1	11	A	B	43	A	B
<b>A</b>	<b>B</b>	<b>B1</b>	*			Trasparente	Niva	Bianco	Silver	Circolare	Bianco	Silver
66↔72	54	27	50	<b>FREE2P66A-</b>				438 €	495 €		385 €	444 €
72↔78	60	30	56	<b>FREE2P72A-</b>				453 €	512 €		399 €	459 €
78↔84	66	33	62	<b>FREE2P78A-</b>			+ 38 €	467 €	529 €		412 €	475 €
84↔90	72	36	68	<b>FREE2P84A-</b>				485 €	548 €		428 €	492 €

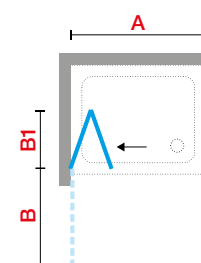
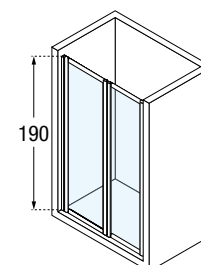

## OPTIONAL

PROFILO DI TENUTA INFERIORE		
Finitura	Codice	Prezzo
Bianco	<b>R55FR2P-A</b>	82 €
Silver	<b>R55FR2P-B</b>	82 €
Cromo	<b>R55FR2P-K</b>	92 €

# FREE 2 U VERSIONE ALTA



190 cm



3 mm



3 cm



## BOX DOCCIA A CENTRO PARETE, APERTURA 2 LATI A 3 ANTE A SOFFIETTO RIPIEGABILI

versione alta - 190 cm



### FINITURE VETRI



Trasparente  
cod 1



Niva  
cod 11



Circolare  
cod 43

### FINITURE PROFILI



Bianco  
cod A



Silver  
cod B

Dimensioni				Codice	Scelta vetro		Scelta profilo		Acrilico	Scelta profilo	
Misura rilevata bordo interno	Misura effettiva d'ingombro		Ingombro anta esterno		1	11	A	B	43	A	B
C	A	B	B1		Trasparente	Niva	Bianco	Silver	Circolare	Bianco	Silver
65↔68	66	66↔69	33	<b>FREE2U68A-</b>	+ 38 €		1.042 €	1.137 €		959 €	1.057 €
68↔71	69	69↔72	34,5	<b>FREE2U71A-</b>			1.042 €	1.137 €		959 €	1.057 €
70↔73	71	71↔74	35,5	<b>FREE2U73A-</b>			1.059 €	1.154 €		975 €	1.072 €
73↔76	74	74↔77	37	<b>FREE2U76A-</b>			1.059 €	1.154 €		975 €	1.072 €
75↔78	76	76↔79	38	<b>FREE2U78A-</b>			1.072 €	1.169 €		987 €	1.087 €
78↔81	79	79↔82	39,5	<b>FREE2U81A-</b>			1.072 €	1.169 €		987 €	1.087 €
81↔84	82	82↔85	41	<b>FREE2U84A-</b>			1.088 €	1.185 €		1.002 €	1.100 €
85↔88	86	86↔89	43	<b>FREE2U88A-</b>			1.088 €	1.185 €		1.002 €	1.100 €
H 85↔190 L 64↔88	SPECIAL			<b>FREE2UALSP</b>	+ 38 €		520 €	568 €		489 €	534 €

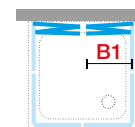
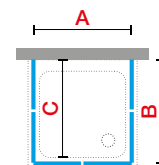
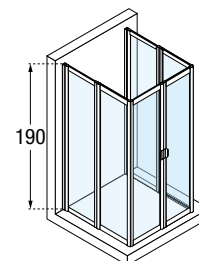

### OPTIONAL

PROFILO DI TENUTA INFERIORE		
Finitura	Codice	Prezzo
Bianco	<b>R55FR2U-A</b>	82 €
Silver	<b>R55FR2U-B</b>	82 €
Cromo	<b>R55FR2U-K</b>	92 €

**SPECIAL: PER COMPORRE UN ANGOLO ORDINARE 2 LATI**

Costruzione del codice + Codice + Vetro/Acrilico + Profilo = Codice prodotto finale

## DATI TECNICI

### FINITURE PROFILI

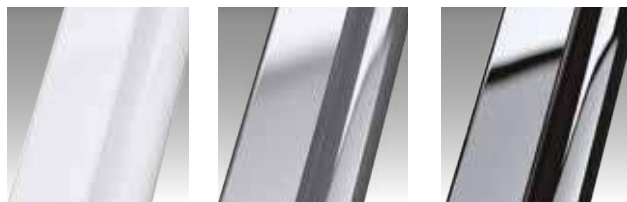

Bianco /  
Bianco opaco  
cod. A/D

Silver  
cod. B

Cromo  
cod. K

### MANIGLIA

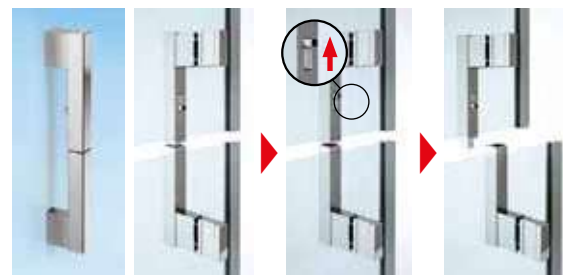

Maniglia cromata  
(solamente per Free 1)

### VETRO TEMPRATO (European Standards EN 14428)

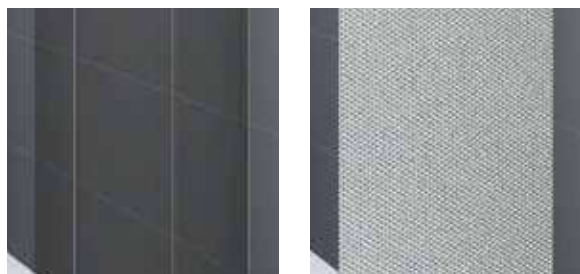

Trasparente  
cod. 1  
Free 1 = 6 mm  
Free 2 = 3 mm



Niva  
cod. 11  
(solamente per Free 2)

### ACRILICO 3 mm



Circolare  
cod. 43  
(solamente per Free 2)

### MISURE DI INGOMBRO PROFILI DI FISSAGGIO - FREE 1 E FREE 2

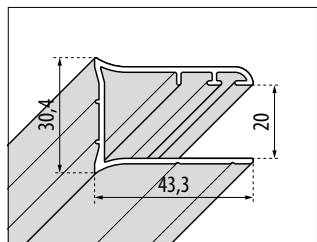

A MURO - FREE 1

**Codice**  
**P01FRDMOST-A** (h 1939)  
**P01FRDMOST-B** (h 1939)  
**P01FRDMOST-K** (h 1939)  
**P01YOU02**

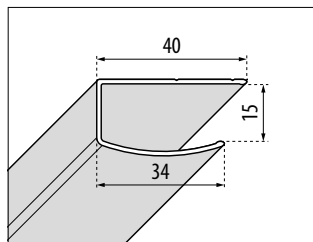

A MURO - FREE 2

**Codice**  
**P01HAAS-A** (h 1900)  
**P01HAAS-B** (h 1900)  
**P01HAA01**  
**P01FR2POAST-A** (h 1890)  
**P01FR2POAST-B** (h 1890)  
**P01FR2POBST-A** (h 840)  
**P01FR2POBST-B** (h 840)

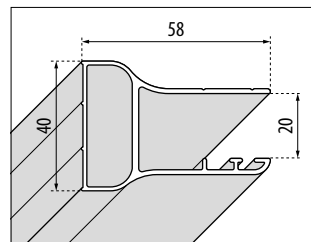

COMPENSAZIONE - FREE 1

**Codice**  
**P04DIAS-A** (h 1950)  
**P04DIAS-B** (h 1950)  
**P04DIA01**

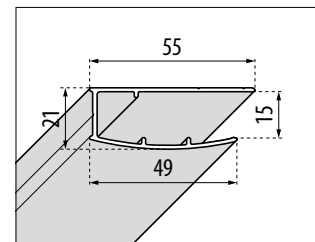

COMPENSAZIONE - FREE 2

**Codice**  
**P01SACST-A** (h 1900)  
**P01SACST-B** (h 1900)  
**P01SAC01**

### COME RILEVARE LE MISURE

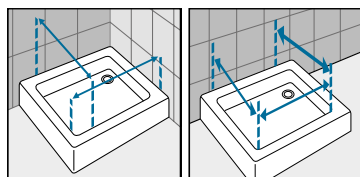

#### FREE 2

Rilevare le misure da muro a bordo interno del piatto doccia. Le misure devono essere rilevate sulla parete finita, a rivestimenti posati, secondo gli schemi riportati.

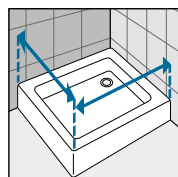

#### FREE 1

Rilevare le misure da muro a bordo esterno del piatto doccia. Le misure devono essere rilevate sulla parete finita, a rivestimenti posati, secondo gli schemi riportati.

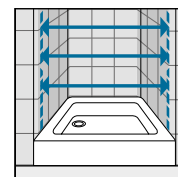

#### FREE 1 e 2

Rilevare le misure da muro a muro, in basso, in alto, al centro e utilizzare quella di valore inferiore. Le misure devono essere rilevate sulla parete finita, a rivestimenti posati, secondo gli schemi riportati.





# RIVIERA

SEMPLICITÀ E VERSATILITÀ  
DI UTILIZZO.



◀ Altezza 1900 mm



◀ Scorrimento a carrelli con ruote



◀ Nuovo design essenziale



Capace di soddisfare esigenze di spazio e di comfort grazie alle numerose configurazioni, la linea è caratterizzata da un'estrema fluidità delle ante scorrevoli, superiore alla media per uno spessore di 3 mm; particolare anche la loro altezza, che raggiungendo i 190 cm consente l'abbinamento di soffioni importanti senza rinunciare alla praticità dell'utilizzo.

Disponibile anche come sopra vasca con differenti sistemi di apertura, trasforma gli ambienti più differenti con la facilità di installazione in totale stile Novellini.

Riviera 2.0 è personalizzabile nei cristalli trasparente, Stampato C o con serigrafia Riviera; in alternativa, è possibile montare l'anta in acrilico ghiaccio.



# RIVIERA

# RIVIERA A

BOX DOCCIA AD ANGOLO APERTURA 2 ANTE SCORREVOLI E 2 FISSE IN LINEA



Misure			Codice	Scelta vetro			Scelta profilo		Scelta acrilico	Scelta profilo	
Misura effettiva d'ingombro	Fisso frontale	Entrata (cm)		1	6	55	A	B	20	A	B
<b>A</b>	<b>F1</b>	<b>F2</b>	*	Trasparente	Stampato C	Serigrafia Riviera	Bianco	Silver	Ghiaccio	Bianco	Silver
62↔64	32	-	35	+ 76 € + 76 €			497 €	547 €		422 €	464 €
67↔69	34	-	40				435 €	479 €			
77↔79	39	-	47				537 €	590 €			
87↔89	44	-	54				563 €	619 €			
97↔99	49	-	61				595 €	655 €			
67↔69x87↔89	34	44	47	537 €	590 €	457 €	503 €				
67↔69x97↔99	34	49	50	553 €	609 €	469 €	518 €				
77↔79x97↔99	39	49	54	567 €	623 €	482 €	529 €				

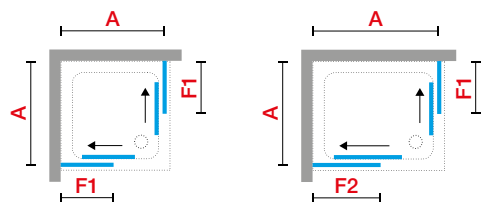
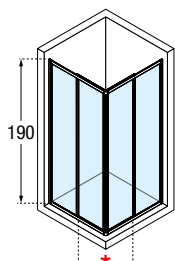

# RIVIERA 2P

PORTA DOCCIA APERTURA 1 ANTA SCORREVOLE E 1 FISSA IN LINEA

In nicchia o abbinabile a pannello fisso laterale RIVIERA F



Misure			Codice	Scelta vetro			Scelta profilo		Scelta acrilico	Scelta profilo	
Misura effettiva d'ingombro	Fisso frontale	Entrata (cm)		1	6	55	A	B	20	A	B
<b>A</b>	<b>F1</b>	*		Trasparente	Stampato C	Serigrafia Riviera	Bianco	Silver	Ghiaccio	Bianco	Silver
<b>PORTA</b>											
96↔100	48	41	<b>RIV22P100-</b>	+ 38 € + 38 €			470 €	519 €		402 €	442 €
116↔120	58	51	<b>RIV22P120-</b>				543 €	597 €	463 €	509 €	

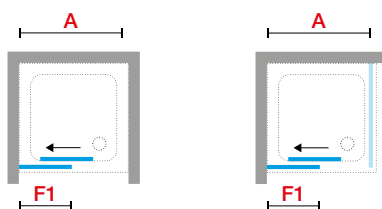
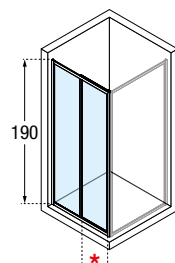

## FINITURE VETRI

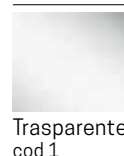

## FINITURE PROFILI

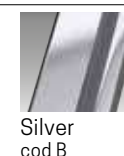
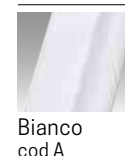

# RIVIERA G



## PORTA DOCCIA, APERTURA 1 ANTA BATTENTE

In nicchia o abbinabile a parete fissa laterale RIVIERA F



Misure			Codice	Scelta vetro			Scelta profilo		Scelta acrilico	Scelta profilo	
Misura effettiva d'ingombro	Entrata (cm)	Ingombro anta esterno		1	6	55	A	B	20	A	B
<b>A</b>	*	<b>B</b>		Traspa- rente	Stampato C	Serigrafia Riviera	Bianco	Silver	Ghiaccio	Bianco	Silver
68↔72	49	48	<b>RIV2G70-</b>				334 €	368 €		285 €	314 €
73↔77	54	53	<b>RIV2G75-</b>				342 €	377 €		292 €	322 €
78↔82	54	54	<b>RIV2G80-</b>	+ 38 €	+ 38 €		355 €	392 €		303 €	333 €
83↔87	59	59	<b>RIV2G85-</b>				360 €	398 €		308 €	339 €
88↔92	64	64	<b>RIV2G90-</b>				368 €	405 €		314 €	347 €

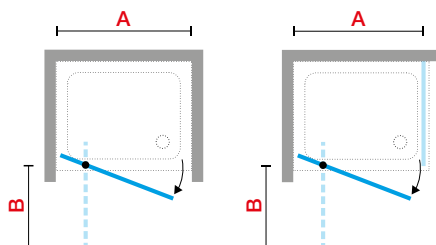
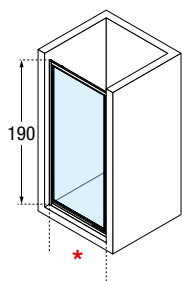

# RIVIERA S



## PORTA DOCCIA, APERTURA 2 ANTE A SOFFIETTO

In nicchia o associata a pannello fisso laterale RIVIERA F



Misure			Codice	Scelta vetro			Scelta profilo		Scelta acrilico	Scelta profilo	
Misura effettiva d'ingombro	Entrata (cm)	Ingombro anta interno		1	6	55	A	B	20	A	B
<b>A</b>	*	<b>B</b>		Traspa- rente	Stampato C	Serigrafia Riviera	Bianco	Silver	Ghiaccio	Bianco	Silver
66↔72	46	28	<b>RIV2S70-</b>				462 €	508 €		394 €	434 €
72↔78	52	31	<b>RIV2S75-</b>				488 €	538 €		415 €	459 €
78↔84	58	34	<b>RIV2S80-</b>	+ 38 €	+ 38 €		514 €	567 €		439 €	483 €
84↔90	64	37	<b>RIV2S85-</b>				542 €	595 €		462 €	508 €

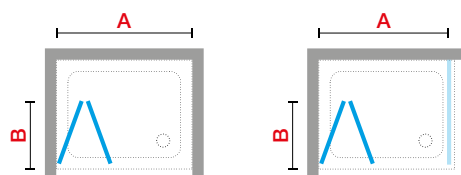
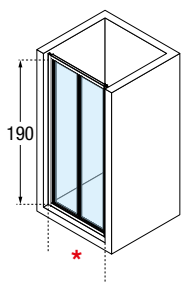

### FINITURE VETRI



### FINITURE PROFILI

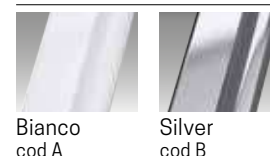

# RIVIERA 3P



## PORTA DOCCIA, APERTURA 3 ANTE, 2 SCORREVOLI + 1 FISSA

In nicchia o associata a parete fissa laterale RIVIERA F



Misure			Codice	Scelta vetro			Scelta profilo		Scelta acrilico 20	Scelta profilo	
Misura effettiva d'ingombro	Fisso frontale	Entrata (cm)		1	6	55	A	B		A	B
<b>A</b>	<b>F1</b>	*		Trasparente	Stampato C	Serigrafia Riviera	Bianco	Silver	Ghiaccio	Bianco	Silver
68↔72	236	37	<b>RIV23P70-</b>				468 €	514 €		399 €	439 €
73↔77	252	40	<b>RIV23P75-</b>				482 €	529 €		409 €	450 €
78↔82	268	43	<b>RIV23P80-</b>		+ 38 €	+ 38 €	494 €	544 €		422 €	464 €
83↔87	286	46	<b>RIV23P85-</b>				508 €	558 €		433 €	477 €
88↔92	302	49	<b>RIV23P90-</b>				522 €	574 €		444 €	489 €

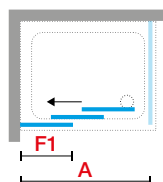
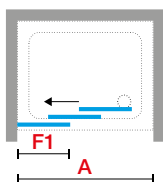
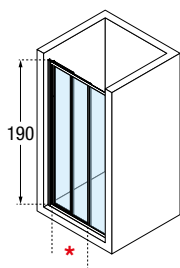

# RIVIERA R



## BOX DOCCIA AD ANGOLO SEMICIRCOLARE, APERTURA 2 ANTE SCORREVOLI E 2 FISSE



Misure				Codice	Scelta vetro		Scelta profilo		Scelta acrilico 20	Scelta profilo	
Misura effettiva d'ingombro	Fisso frontale	Entrata (cm)	Raggio		1	6	A	B		A	B
<b>A</b>	<b>F1</b>	*	<b>R</b>		Trasparente	Stampato C	Bianco	Silver	Ghiaccio	Bianco	Silver
78,5↔81,5	24	40	55	<b>RIV2R80-</b>			780 €	858 €		664 €	732 €
88,5↔91,5	34	54	55	<b>RIV2R90-</b>		+ 76 €	798 €	879 €		679 €	748 €

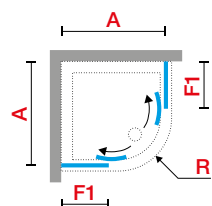
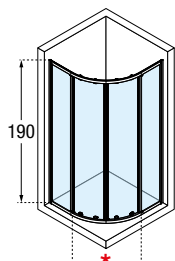

# RIVIERA F

## PARETE FISSA LATERALE



Misure	Codice	Scelta vetro			Scelta profilo		Scelta acrilico	Scelta profilo	
		1	6	55	A	B		A	B
Misura effettiva d'ingombro							20		
<b>F</b>		Trasparente	Stampato C	Serigrafia Riviera	Bianco	Silver	Ghiaccio	Bianco	Silver
68↔72	<b>RIV2F70-</b>				235 €	258 €		200 €	220 €
73↔77	<b>RIV2F75-</b>				248 €	274 €		212 €	234 €
78↔82	<b>RIV2F80-</b>		+ 38 €	+ 38 €	262 €	288 €		223 €	245 €
83↔87	<b>RIV2F85-</b>				275 €	303 €		235 €	258 €
88↔92	<b>RIV2F90-</b>				288 €	318 €		245 €	272 €

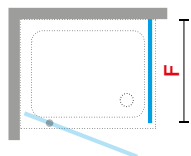
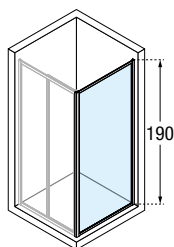

### FINITURE PROFILI



Bianco  
cod. A



Silver  
cod. B

### VETRO TEMPRATO 3 mm



Trasparente  
cod. 1



Stampato C  
cod. 6

### SERIGRAFIA



Riviera  
cod. 55

### ACRILICO



Ghiaccio  
cod. 20

### MISURE DI INGOMBRO PROFILI DI FISSAGGIO

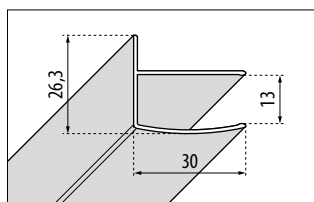

**A MURO**  
RIVIERA A - G - 3P - 2P

Finitura	Codice
Bianco	<b>P01BC3MOST-A</b>
Silver	<b>P01BC3MOST-B</b>

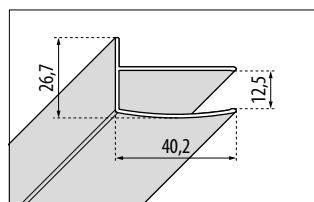

**A MURO**  
RIVIERA S

Finitura	Codice
Bianco	<b>P01BC3SST-A</b>
Silver	<b>P01BC3SST-B</b>

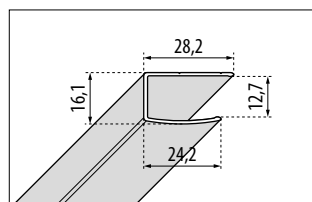

**A MURO**  
RIVIERA R

Finitura	Codice
Bianco	<b>P01BCRST-A</b>
Silver	<b>P01BCRST-B</b>

### COME RILEVARE LE MISURE

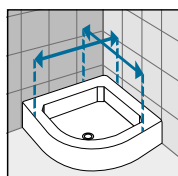
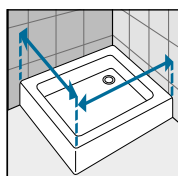

Rilevare le misure da muro a bordo esterno del piatto doccia. Le misure devono essere rilevate sulla parete finita, a rivestimenti posati, secondo gli schemi riportati.

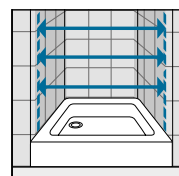

Rilevare le misure da muro a muro, in basso, in alto, al centro e utilizzare quella di valore inferiore. Le misure devono essere rilevate sulla parete finita, a rivestimenti posati, secondo gli schemi riportati.

Costruzione del codice + Codice + Vetro + Profilo = Codice prodotto finale

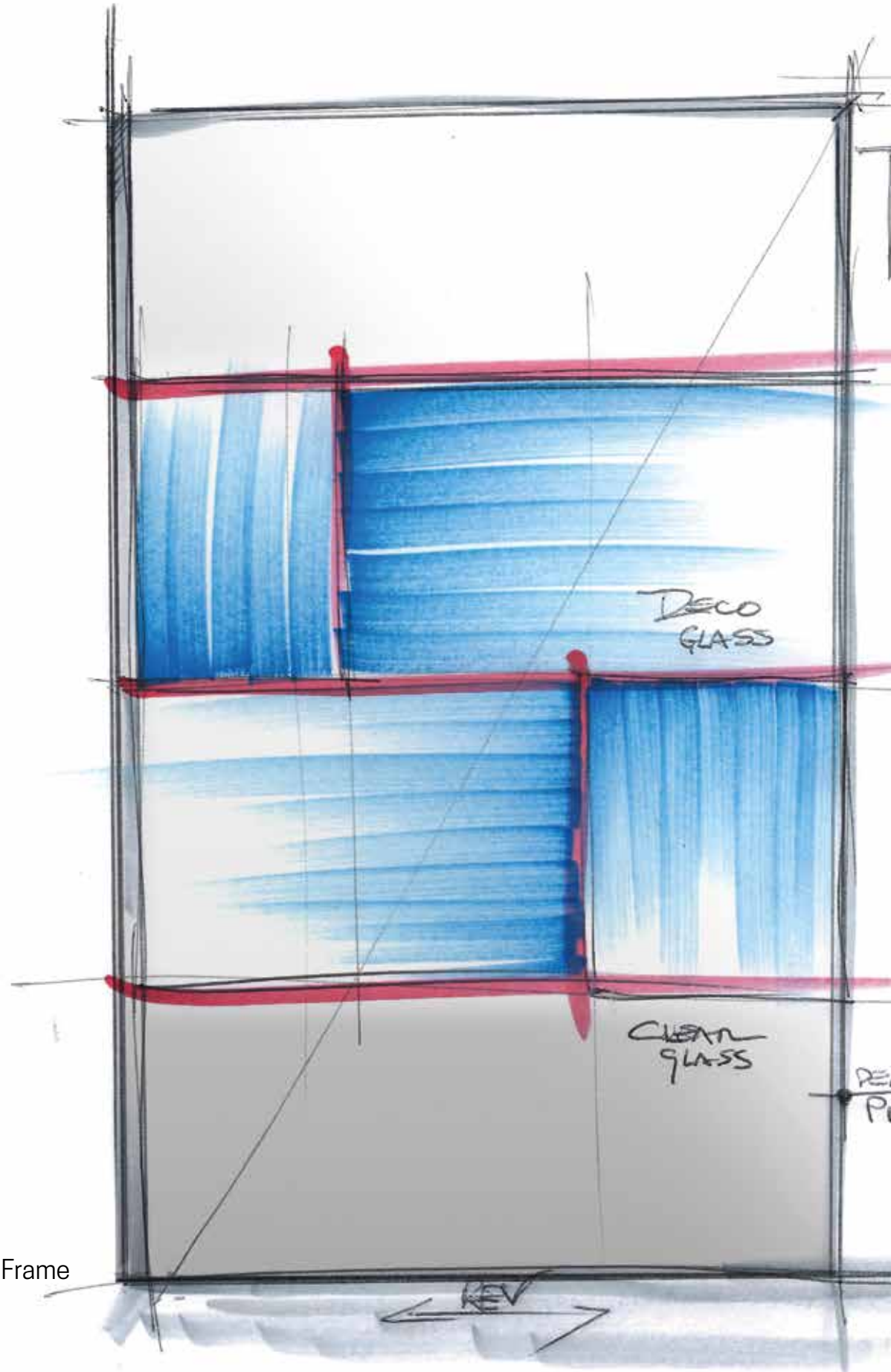

- 257 Kuadra H
- 273 Kuadra H Collection Frame
- 288 Kuadra H In Art
- 295 H Style
- 299 H Art
- 305 Giada H Collection Edge
- 318 Lunes H



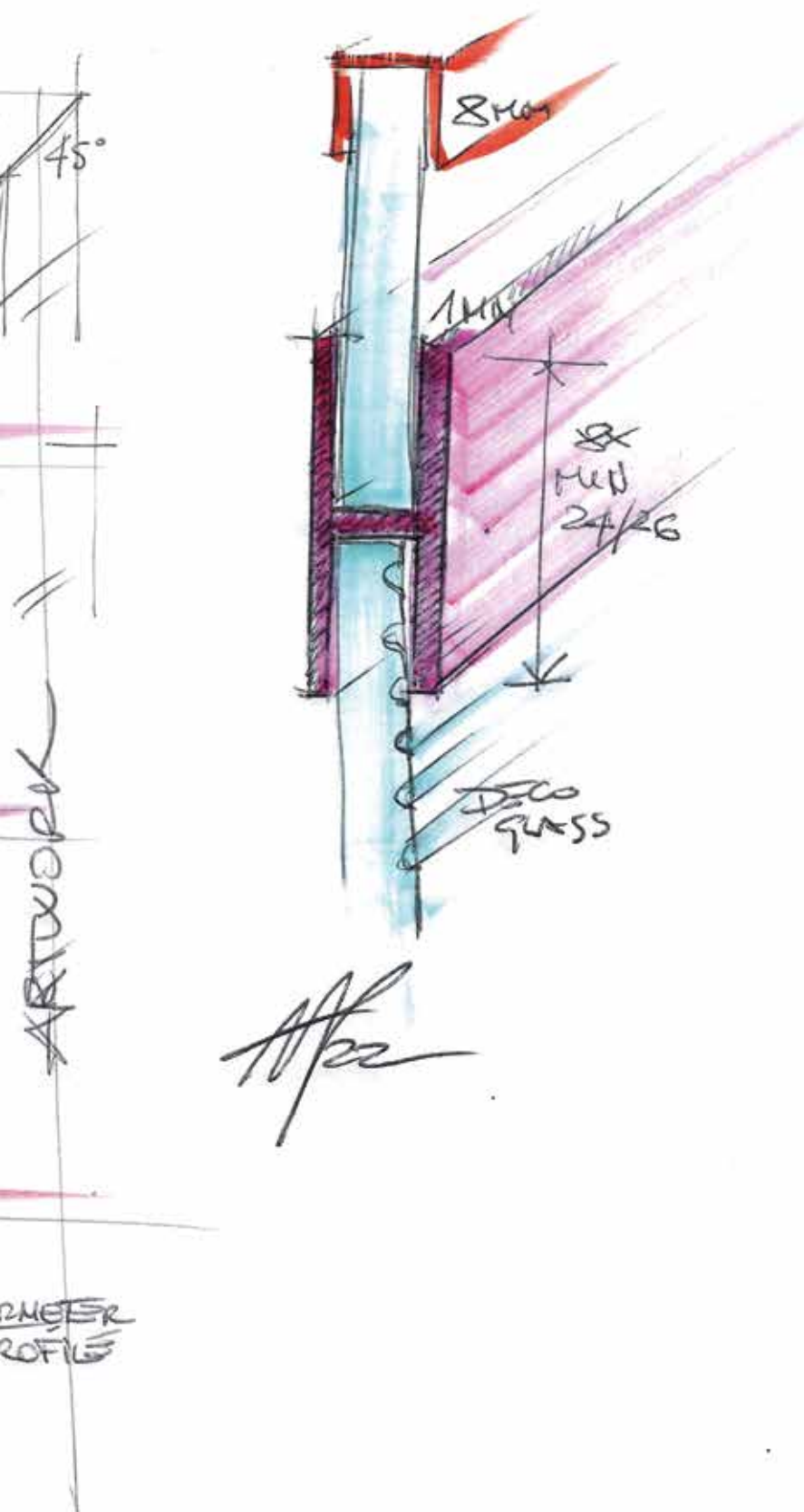

# SPAZI DOCCIA

LA QUALITÀ  
E L'ELEGANZA  
IN UN COLPO  
D'OCCHIO UNICO.

Il design si trasforma per seguire il tuo stile. Gli spazi doccia Novellini si inseriscono con eleganza negli ambienti bagno più moderni e accattivanti, studiati per chi vuole rompere lo schema classico e dar vita al proprio progetto senza rinunciare alla funzionalità. L'ampia serie di elementi è configurabile a piacere per combinazioni walk-in essenziali ed eleganti, dall'impatto visivo unico.

# KUADRA H



◀ robuste pareti doccia da 8 mm con possibilità di diversi sistemi di fissaggio a parete/soffitto



◀ elevata combinabilità degli elementi per creare spazi doccia WALK IN a misura, in nicchia, ad angolo, a parete



◀ ampia gamma di modelli disponibili con finiture profili e lastre disponibile con diverse finiture colore

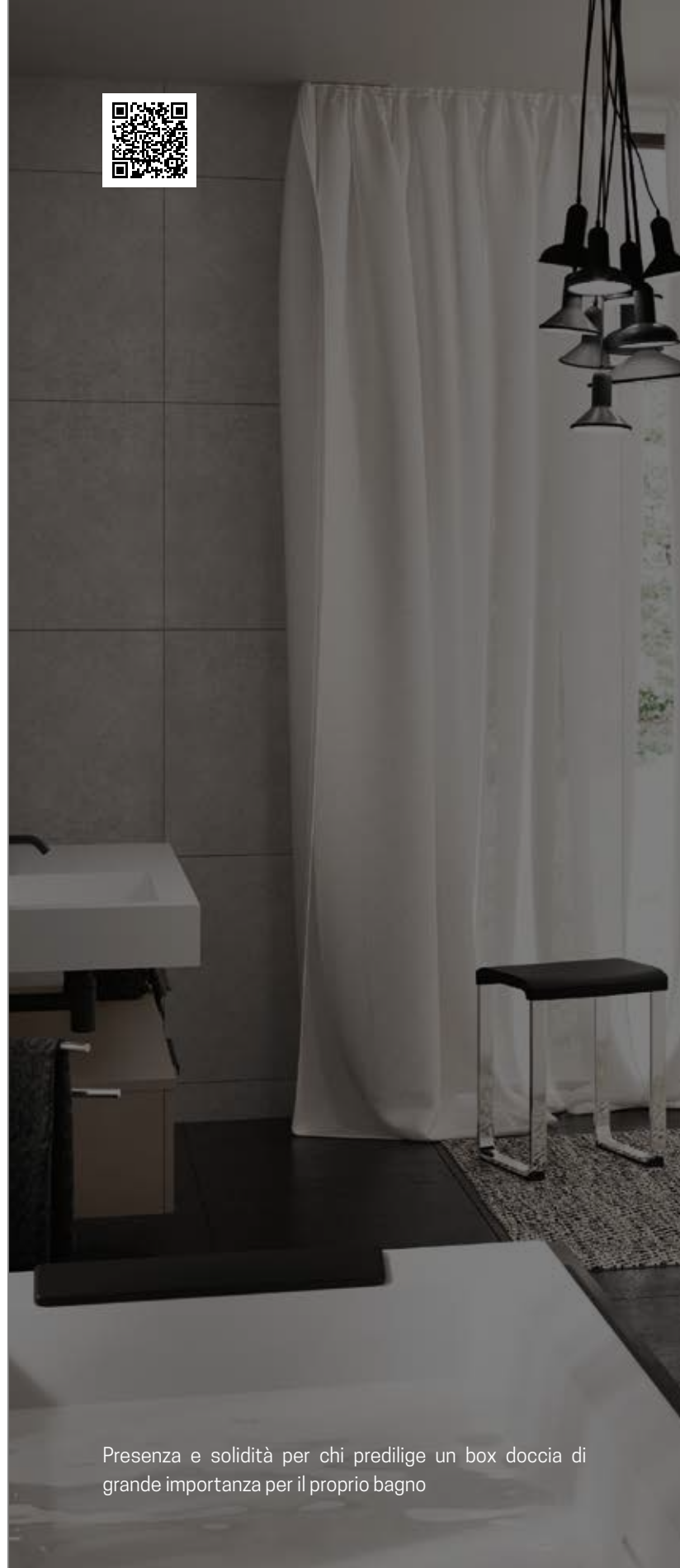

Presenza e solidità per chi predilige un box doccia di grande importanza per il proprio bagno

## TRATTAMENTI





KUADRA H

# KUADRA H

## PARETE FISSA

Misure	Codice	Scelta vetro			Scelta profilo					
Misura effettiva d'ingombro		1	44	51	U	B	K	H	O M L	P R Q N Z
<b>A</b>		Trasparente	Band Satin	Serigrafia Ravenna	Bianco opaco	Silver	Cromo	Nero opaco	Oro lucido Oro rosa lucido Cromo nero lucido	Oro spazzolato Oro rosa spazzolato Bronzo spazzolato Cromo nero spazzolato Inox
27↔30	<b>KUADH30-</b>				338 €	375 €	413 €	413 €	648 €	568 €
37↔40	<b>KUADH40-</b>				400 €	450 €	500 €	500 €	735 €	655 €
47↔50	<b>KUADH50-</b>	●			463 €	513 €	575 €	575 €	810 €	730 €
57↔60	<b>KUADH60-</b>	●			532 €	582 €	638 €	638 €	873 €	793 €
67↔70	<b>KUADH70-</b>	●			532 €	582 €	638 €	638 €	873 €	793 €
72↔75	<b>KUADH75-</b>	●			532 €	582 €	638 €	638 €	873 €	793 €
77↔80	<b>KUADH80-</b>	●			600 €	650 €	707 €	707 €	942 €	862 €
87↔90	<b>KUADH90-</b>	●	+ 38 €	+ 38 €	600 €	650 €	707 €	707 €	942 €	862 €
97↔100	<b>KUADH100-</b>	●			600 €	650 €	707 €	707 €	942 €	862 €
107↔110	<b>KUADH110-</b>	●			657 €	713 €	775 €	775 €	1.010 €	930 €
117↔120	<b>KUADH120-</b>	●			657 €	713 €	775 €	775 €	1.010 €	930 €
127↔130	<b>KUADH130-</b>	●			725 €	782 €	844 €	844 €	1.079 €	999 €
137↔140	<b>KUADH140-</b>	●			725 €	782 €	844 €	844 €	1.079 €	999 €
147↔150	<b>KUADH150-</b>	●			782 €	844 €	913 €	913 €	1.148 €	1.068 €
157↔160	<b>KUADH160-</b>	●			782 €	844 €	913 €	913 €	1.148 €	1.068 €
L 20↔180 H 80↔240 SPECIAL	<b>KUADHSP</b>		+ 38 €	-	969 €	1.063 €	1.175 €	1.175 €	-	-
L 20↔180 H 80↔240 SPECIAL	<b>KUADHCRSP</b>		+ 38 €	-	-	-	-	-	1.410 €	1.330 €

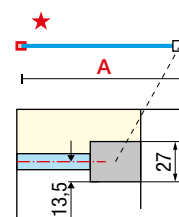
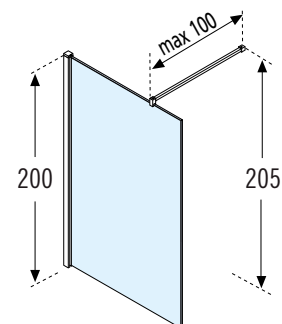

Piedini di fissaggio al pavimento



**DI SERIE, BARRA DI SOSTEGNO DA 100 CM**  
**LA BARRA DI SOSTEGNO DA 150 CM È OPTIONAL (VEDI PAG. 316)**

### SISTEMA DI FISSAGGIO EVO (IN NICCHIA)



Finitura	Codice	Prezzo
Bianco opaco	<b>KUADHSFN-U</b>	170 €
Silver	<b>KUADHSFN-B</b>	183 €
Cromo	<b>KUADHSFN-K</b>	204 €
Nero opaco	<b>KUADHSFN-H</b>	204 €
Inox sp.	<b>KUADHSFN-Z</b>	245 €

- 1 barra frontale da 180 cm
- 1 morsetto di fissaggio

### SISTEMA DI FISSAGGIO EVO (ANGOLO)



Finitura	Codice	Prezzo
Bianco opaco	<b>KUADHSF-U</b>	229 €
Silver	<b>KUADHSF-B</b>	247 €
Cromo	<b>KUADHSF-K</b>	267 €
Nero opaco	<b>KUADHSF-H</b>	267 €
Inox sp.	<b>KUADHSF-Z</b>	321 €

- 1 barra frontale da 180 cm
- 1 barra laterale da 120 cm
- 2 morsetti di fissaggio
- 1 angolare di unione

### PROFILO DI FISSAGGIO A SOFFITTO



Finitura	Codice	Prezzo
Bianco	<b>R80GKHSOF-D</b>	190 €
Bianco opaco	<b>R80GKHSOF-U</b>	190 €
Silver	<b>R80GKHSOF-B</b>	209 €
Cromo	<b>R80GKHSOF-K</b>	230 €
Nero opaco	<b>R80GKHSOF-H</b>	230 €
Inox sp.	<b>R80GKHSOF-Z</b>	276 €



**FINITURE VETRI**



Trasparente  
**cod. 1**



Banda satin  
**cod. 44**

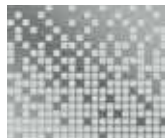

Ser. Ravenna  
**cod. 51**

**FINITURE PROFILI**



Bianco opaco  
**cod. U**



Silver  
**cod. B**



Cromo  
**cod. K**



Nero opaco  
**cod. H**

**FINITURE PROFILI "COLORATISSIMI 1985-2023"**

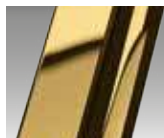

Oro lucido  
**cod. O**



Oro rosa lucido  
**cod. M**



Cromo nero  
lucido  
**cod. L**

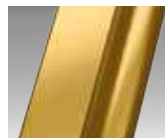

Oro  
spazzolato  
**cod. P**

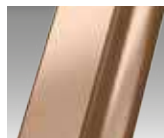

Oro rosa  
spazzolato  
**cod. R**



Cromo nero  
spazzolato  
**cod. N**

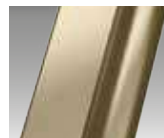

Bronzo  
spazzolato  
**cod. Q**

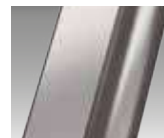

Inox  
spazzolato  
**cod. Z**

# KUADRA HFA

ANTINA GIREVOLE PER PARETE FISSA



200 cm



8 mm



Porta  
trasparente



## FINITURE VETRI



Trasparente  
cod. 1



Band Satin  
cod. 44



Spy  
cod. 76

## FINITURE PROFILI



Bianco opaco  
cod. U



Cromo  
cod. K



Nero opaco  
cod. H

## COLORATISSIMI



Oro lucido  
cod. O



Oro rosa  
lucido  
cod. M



Cromo nero  
lucido  
cod. L



Oro spazzolato  
cod. P



Oro rosa  
spazzolato  
cod. R



Cromo nero  
spazzolato  
cod. N



Bronzo  
spazzolato  
cod. Q



Inox  
spazzolato  
cod. Z

Misure	Codice	Scelta vetro		Scelta profilo							Scelta vetro	Scelta profilo			
		1	44	U	K	H	O	P	R	76		U	K	H	Z
Misura effettiva d'ingombro							M	Q	N	Z					
<b>A</b>		Trasparente	Band Satin	Bianco opaco	Cromo	Nero opaco	Oro lucido Oro rosa lucido Cromo nero lucido	Oro spazzolato Oro rosa spazzolato Bronzo spazzolato Cromo nero spazzolato Inox	Spy	Bianco opaco	Cromo	Nero opaco	Inox		
37	<b>KUADHA37-</b>	●	-	288 €	288 €	288 €	375 €	346 €		367 €	367 €	367 €	440 €		
37	<b>KUADHA37D-</b>	-	+38 €	288 €	288 €	288 €	375 €	346 €							
37	<b>KUADHA37S-</b>	-		288 €	288 €	288 €	375 €	346 €							

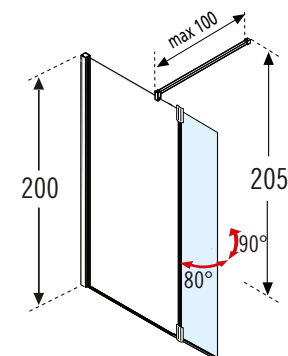

# KUADRA HFP2

ANTINA GIREVOLE PER PARETE FISSA



200 cm



6 mm



## FINITURE VETRI



Trasparente  
cod. 1

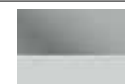

Band Satin  
cod. 44

## FINITURE PROFILI



Bianco opaco  
cod. U



Silver  
cod. B



Cromo  
cod. K



Nero opaco  
cod. H

Misure	Codice	Scelta vetro		Scelta profilo			
		1	44	U	B	K	H
Misura effettiva d'ingombro		Trasparente	Band Satin	Bianco opaco	Silver	Cromo	Nero opaco
<b>A</b>	<b>KUADHAP37-</b>		+ 38 €	274 €	301 €	330 €	330 €
40							

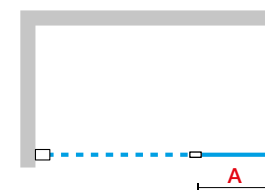
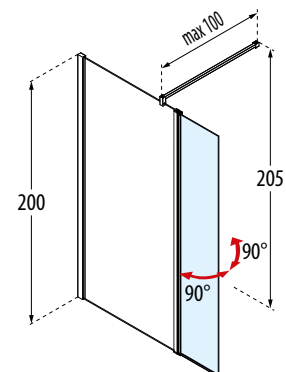

Costruzione del codice

Codice

+

Sinistra/Destra

+

Vetro

+

Profilo

=

Codice prodotto finale

# KUADRA H DESIGN



## PARETE FISSA

Misure	Codice	Scelta vetro					Scelta profilo
Misura effettiva d'ingombro		81	82	84	85	86	H
<b>A</b>		Squares	Stripes	Serigrafia Wires	Serigrafia Plaid	Serigrafia Frame	Nero opaco
27↔30	<b>KUADH30-</b>	-	-				538 €
37↔40	<b>KUADH40-</b>	-	-				625 €
47↔50	<b>KUADH50-</b>	-	-				700 €
57↔60	<b>KUADH60-</b>	-	-				763 €
67↔70	<b>KUADH70-</b>	-	-				763 €
72↔75	<b>KUADH75-</b>	-	-				763 €
77↔80	<b>KUADH80-</b>						832 €
87↔90	<b>KUADH90-</b>						832 €
97↔100	<b>KUADH100-</b>						832 €
107↔110	<b>KUADH110-</b>	-	-				900 €
117↔120	<b>KUADH120-</b>						900 €
127↔130	<b>KUADH130-</b>	-	-				969 €
137↔140	<b>KUADH140-</b>						969 €
147↔150	<b>KUADH150-</b>	-	-				1.038 €
157↔160	<b>KUADH160-</b>						1.038 €

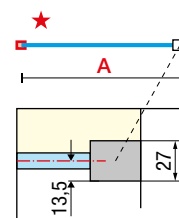
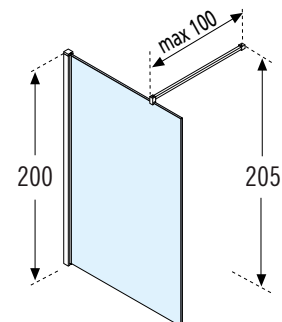

Piedini di fissaggio al pavimento



**DI SERIE, BARRA DI SOSTEGNO DA 100 CM**  
**LA BARRA DI SOSTEGNO DA 150 CM È OPTIONAL (VEDI PAG. 316)**

### SISTEMA DI FISSAGGIO EVO (IN NICCHIA)



Finitura	Codice	Prezzo
Bianco opaco	<b>KUADHSFN-U</b>	170 €
Silver	<b>KUADHSFN-B</b>	183 €
Cromo	<b>KUADHSFN-K</b>	204 €
Nero opaco	<b>KUADHSFN-H</b>	204 €
Inox sp.	<b>KUADHSFN-Z</b>	245 €

- 1 barra frontale da 180 cm
- 1 morsetto di fissaggio

### SISTEMA DI FISSAGGIO EVO (ANGOLO)



Finitura	Codice	Prezzo
Bianco opaco	<b>KUADHSF-U</b>	229 €
Silver	<b>KUADHSF-B</b>	247 €
Cromo	<b>KUADHSF-K</b>	267 €
Nero opaco	<b>KUADHSF-H</b>	267 €
Inox sp.	<b>KUADHSF-Z</b>	321 €

- 1 barra frontale da 180 cm
- 1 barra laterale da 120 cm
- 2 morsetti di fissaggio
- 1 angolare di unione

### PROFILO DI FISSAGGIO A SOFFITTO



Finitura	Codice	Prezzo
Bianco	<b>R80GKHSOF-D</b>	190 €
Bianco opaco	<b>R80GKHSOF-U</b>	190 €
Silver	<b>R80GKHSOF-B</b>	209 €
Cromo	<b>R80GKHSOF-K</b>	230 €
Nero opaco	<b>R80GKHSOF-H</b>	230 €
Inox sp.	<b>R80GKHSOF-Z</b>	276 €





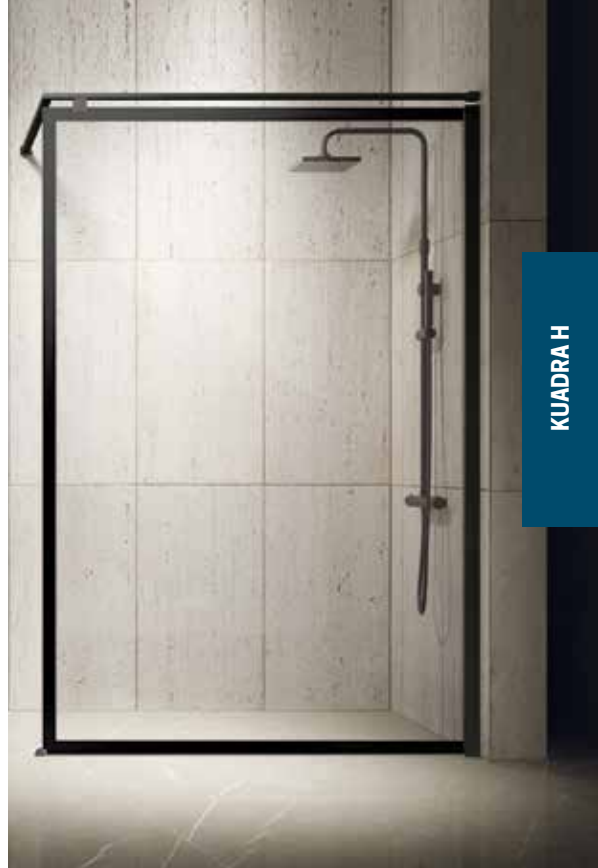

DIMENSIONI SQUARES

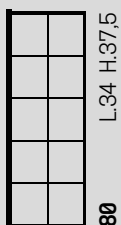

80

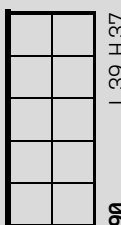

90

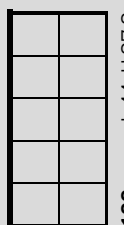

100

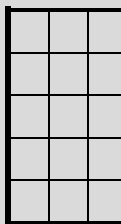

120

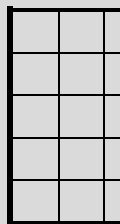

140

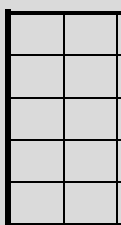

160



FINITURE VETRI



Serigrafia Wires  
cod. 84

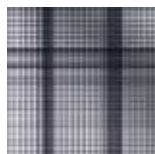

Serigrafia Plaid  
cod. 85



Serigrafia Frame  
cod. 86

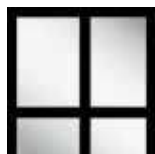

Squares  
cod. 81

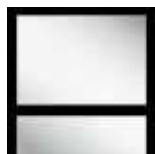

Stripes  
cod. 82

FINITURE PROFILI



Nero  
cod. H

# KUADRA H FUMÈ



200 cm



8 mm



3 cm



## PARETE FISSA

Misure	Codice	Scelta vetro		Scelta profilo				
Misura effettiva d'ingombro		54	87	U	B	K	H	Z
<b>A</b>		Fumé	Banda Black	Bianco opaco	Silver	Cromo	Nero opaco	Inox
67↔70	<b>KUADH70-</b>	+ 125 €		657 €	709 €	767 €	767 €	922 €
77↔80	<b>KUADH80-</b>			732 €	790 €	854 €	854 €	1.009 €
87↔90	<b>KUADH90-</b>			732 €	790 €	854 €	854 €	1.009 €
97↔100	<b>KUADH100-</b>			732 €	790 €	854 €	854 €	1.009 €
117↔120	<b>KUADH120-</b>			794 €	858 €	927 €	927 €	1.082 €
137↔140	<b>KUADH140-</b>			875 €	945 €	1.022 €	1.022 €	1.177 €
L 20↔180 H 80↔240 SPECIAL	<b>KUADHSP</b>	+ 125 €		1.207 €	1.319 €	1.438 €	1.438 €	1.593 €

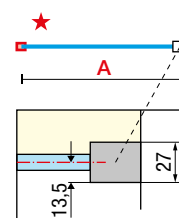
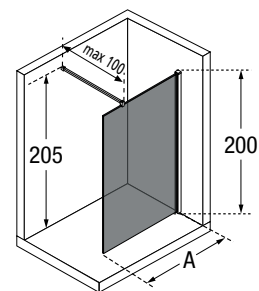

Piedini di fissaggio al pavimento



**DI SERIE, BARRA DI SOSTEGNO DA 100 CM  
LA BARRA DI SOSTEGNO DA 150 CM È OPTIONAL (VEDI PAG. 316)**

### SISTEMA DI FISSAGGIO EVO (IN NICCHIA)



Finitura	Codice	Prezzo
Bianco opaco	<b>KUADHSFN-U</b>	170 €
Silver	<b>KUADHSFN-B</b>	183 €
Cromo	<b>KUADHSFN-K</b>	204 €
Nero opaco	<b>KUADHSFN-H</b>	204 €
Inox sp.	<b>KUADHSFN-Z</b>	245 €

- 1 barra frontale da 180 cm
- 1 morsetto di fissaggio

### SISTEMA DI FISSAGGIO EVO (ANGOLO)



Finitura	Codice	Prezzo
Bianco opaco	<b>KUADHSF-U</b>	229 €
Silver	<b>KUADHSF-B</b>	247 €
Cromo	<b>KUADHSF-K</b>	267 €
Nero opaco	<b>KUADHSF-H</b>	267 €
Inox sp.	<b>KUADHSF-Z</b>	321 €

- 1 barra frontale da 180 cm
- 1 barra laterale da 120 cm
- 2 morsetti di fissaggio
- 1 angolare di unione

### PROFILO DI FISSAGGIO A SOFFITTO



Finitura	Codice	Prezzo
Bianco	<b>R80GKHSOF-D</b>	190 €
Bianco opaco	<b>R80GKHSOF-U</b>	190 €
Silver	<b>R80GKHSOF-B</b>	209 €
Cromo	<b>R80GKHSOF-K</b>	230 €
Nero opaco	<b>R80GKHSOF-H</b>	230 €
Inox sp.	<b>R80GKHSOF-Z</b>	276 €





KUADRA H

SERIGRAFIA FUMÉ BARRA EVO (OPTIONAL VEDI PAG. 316)



SERIGRAFIA BANDA BLACK SU VETRO FUMÉ E BARRA SOFFITTO (OPTIONAL VEDI PAG. 316)

FINITURE VETRI

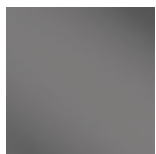

Fumé  
cod. 54



Banda Black  
cod. 87

FINITURE PROFILI



Bianco opaco  
cod. U

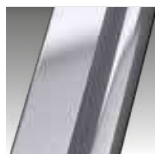

Silver  
cod. B



Cromo  
cod. K



Nero  
cod. H



Inox  
cod. Z

# KUADRA H SPY

PARETE FISSA CON FINITURA A SPECCHIO



200 cm



8 mm



3 cm



## FINITURE VETRI



Spy  
cod 76

## FINITURE PROFILI



Bianco Opaco  
cod U



Silver  
cod B



Cromo  
cod K



Nero  
cod H



Inox  
cod Z

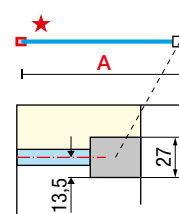
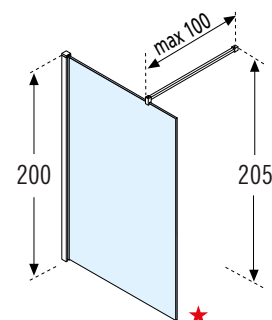

Piedini di fissaggio al pavimento



Misure	Codice	Scelta vetro	Scelta profilo				
			76	U	B	K	H
Misura effettiva d'ingombro		76	U	B	K	H	Z
<b>A</b>		Spy	Bianco opaco	Silver	Cromo	Nero opaco	Inox
27↔30	<b>KUADH30-</b>		494 €	538 €	588 €	588 €	743 €
37↔40	<b>KUADH40-</b>		569 €	619 €	675 €	675 €	830 €
47↔50	<b>KUADH50-</b>		632 €	688 €	750 €	750 €	905 €
57↔60	<b>KUADH60-</b>		682 €	744 €	813 €	813 €	968 €
67↔70	<b>KUADH70-</b>		694 €	757 €	825 €	825 €	980 €
77↔80	<b>KUADH80-</b>		732 €	800 €	875 €	875 €	1.030 €
87↔90	<b>KUADH90-</b>		825 €	900 €	988 €	988 €	1.143 €
97↔100	<b>KUADH100-</b>		869 €	950 €	1.038 €	1.038 €	1.193 €
117↔120	<b>KUADH120-</b>		969 €	1.063 €	1.163 €	1.163 €	1.318 €
L 20↔180 H 80↔240 SPECIAL	<b>KUADHSP</b>		1.325 €	1.444 €	1.582 €	1.582 €	1.737 €

DI SERIE, BARRA DI SOSTEGNO DA 100 CM - LA BARRA DI SOSTEGNO DA 150 CM È OPTIONAL (VEDI PAG. 316)

## OPTIONAL

Finitura	Codice	Prezzo
Bianco opaco	<b>KUADHSFN-U</b>	170 €
Silver	<b>KUADHSFN-B</b>	183 €
Cromo	<b>KUADHSFN-K</b>	204 €
Nero opaco	<b>KUADHSFN-H</b>	204 €
Inox sp.	<b>KUADHSFN-Z</b>	245 €

**SISTEMA DI FISSAGGIO EVO (in nicchia)**

- 1 barra frontale da 180 cm
- 1 morsetto di fissaggio

Finitura	Codice	Prezzo
Bianco opaco	<b>KUADHSF-U</b>	229 €
Silver	<b>KUADHSF-B</b>	247 €
Cromo	<b>KUADHSF-K</b>	267 €
Nero opaco	<b>KUADHSF-H</b>	267 €
Inox sp.	<b>KUADHSF-Z</b>	321 €

**SISTEMA DI FISSAGGIO EVO (angolo)**

- 1 barra frontale da 180 cm
- 1 barra laterale da 120 cm
- 2 morsetti di fissaggio
- 1 angolare di unione



# KUADRA HF

FISSO CENTRALE



200 cm



8 mm



SISTEMA DI FISSAGGIO EVO A C (OPTIONAL)

## FINITURE VETRI



Trasparente  
cod. 1



Ser. Ravenna  
cod. 51



Spy  
cod. 76

## FINITURE PROFILI



Bianco Opaco  
cod. U



Silver  
cod. B



Cromo  
cod. K



Nero  
cod. H



Inox  
cod. Z

Misure	Codice	Scelta vetro		Scelta profilo					Scelta vetro	Scelta profilo				
		1	51	U	B	K	H	Z		76	U	B	K	H
Misura effettiva d'ingombro		Trasparente	Serigrafia Ravenna	Bianco opaco	Silver	Cromo	Nero opaco	Inox	Spy	Bianco opaco	Silver	Cromo	Nero opaco	Inox
<b>C</b>														
94	<b>KUADFC96-</b>			657 €	713 €	775 €	775 €	930 €		869 €	950 €	1.038 €	1.038 €	1.193 €
114	<b>KUADFC116-</b>			682 €	738 €	800 €	800 €	955 €		969 €	1.063 €	1.163 €	1.163 €	1.318 €
134	<b>KUADFC136-</b>		+38 €	732 €	788 €	850 €	850 €	1.005 €						
154	<b>KUADFC156-</b>			769 €	832 €	900 €	900 €	1.055 €						

L 80↔180  
H 80↔240  
SPECIAL

**KUADFCSP**

- 1.144 € 1.250 € 1.363 € 1.363 € 1.518 €

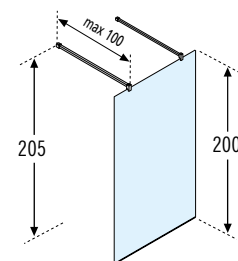

DI SERIE, BARRA DI SOSTEGNO DA 100 CM - LA BARRA DI SOSTEGNO DA 150 CM È OPTIONAL (VEDI PAG. 316)

## OPTIONAL



**SISTEMA DI FISSAGGIO EVO (a C)**

- 1 barra frontale da 180 cm
- 2 barre laterali da 120 cm
- 4 morsetti di fissaggio
- 2 angolari di unione

Finitura	Codice	Prezzo
Bianco opaco	<b>KUADHSFC-U</b>	297 €
Silver	<b>KUADHSFC-B</b>	310 €
Cromo	<b>KUADHSFC-K</b>	329 €
Nero opaco	<b>KUADHSFC-H</b>	329 €
Inox sp.	<b>KUADHSFC-Z</b>	395 €

Piedini di fissaggio al pavimento



Costruzione del codice **Codice** + **Vetro** + **Profilo** = Codice prodotto finale

# KUADRA HL

FISSO LATERALE PER KUADRA H



## FINITURE VETRI



## FINITURE PROFILI



Misure	Codice	Scelta vetro			Scelta profilo					Scelta vetro	Scelta profilo				
		1	44	51	U	B	K	H	Z		76	U	B	K	H
Misura effettiva d'ingombro		Trasparente	Band Satin	Serigrafia Ravenna	Bianco opaco	Silver	Cromo	Nero opaco	Inox	Spy	Bianco opaco	Silver	Cromo	Nero opaco	Inox

### PARETE

D	Codice	Scelta vetro	U	B	K	H	Z	76	U	B	K	H	Z
68	KUADHL70-		413 €	457 €	513 €	513 €	668 €		569 €	625 €	682 €	682 €	837 €
78	KUADHL80-		438 €	482 €	538 €	538 €	693 €		600 €	657 €	719 €	719 €	874 €
88	KUADHL90-		463 €	507 €	563 €	563 €	718 €		682 €	744 €	813 €	813 €	968 €
98	KUADHL100-	+38 € +38 €	488 €	532 €	588 €	588 €	743 €		707 €	775 €	850 €	850 €	1.005 €
118	KUADHL120-		513 €	557 €	613 €	613 €	768 €		800 €	875 €	957 €	957 €	1.112 €
138	KUADHL140-		538 €	582 €	638 €	638 €	793 €						
158	KUADHL160-		563 €	607 €	663 €	663 €	818 €						

### ALETTA

F	Codice	Scelta vetro	U	B	K	H	Z	76	U	B	K	H	Z
15	KUADHL15-		175 €	194 €	213 €	213 €	255 €						
30	KUADHL30-	+38 €	194 €	213 €	232 €	232 €	278 €						
40	KUADHL40-		219 €	238 €	257 €	257 €	308 €						

L 115↔160 H 80↔240 SPECIAL	KUADHLSP		825 €	894 €	1.069 €	1.069 €	1.224 €		1.119 €	1.219 €	1.332 €	1.332 €	1.487 €
----------------------------------	----------	--	-------	-------	---------	---------	---------	--	---------	---------	---------	---------	---------

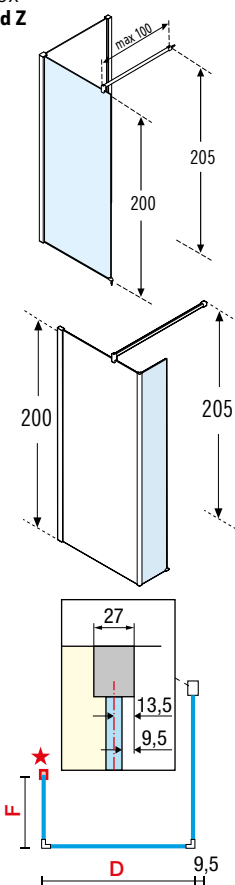

Piedini di fissaggio al pavimento



**LA BARRA DI SOSTEGNO DA 150 CM È OPTIONAL (VEDI PAG. 316)  
IN CASO DI INSTALLAZIONE "ALETTA" SU PIATTO DOCCIA PRENDERE IL PIEDINO DI FISSAGGIO SU PIATTO (VEDI PAG. 317)**



# COMBINAZIONI

## KUADRA H+HFA VERSIONE IN NICCHIA

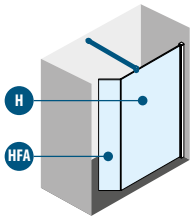

**KUADRA H  
KUADRA HFA  
BARRA DI SOSTEGNO**  
(in dotazione)

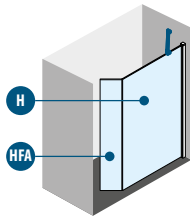

**KUADRA H  
KUADRA HFA  
BARRA ORIENTABILE**

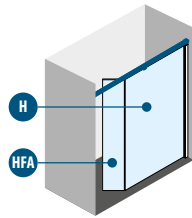

**KUADRA H  
KUADRA HFA  
BARRA EVO (in nicchia)**

## KUADRA H+HFA VERSIONE AD ANGOLO

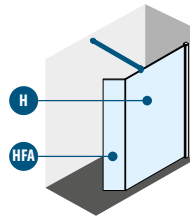

**KUADRA H  
KUADRA HFA  
BARRA DI SOSTEGNO**  
(in dotazione)

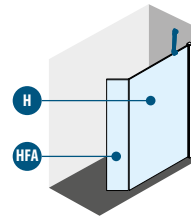

**KUADRA H  
KUADRA HFA  
BARRA ORIENTABILE**

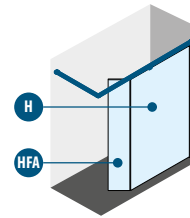

**KUADRA H  
KUADRA HFA  
BARRA EVO (ad angolo)**

## KUADRA H+HFP2 VERSIONE IN NICCHIA

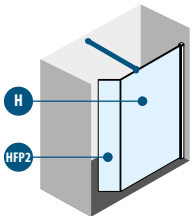

**KUADRA H  
KUADRA HFP2  
BARRA DI SOSTEGNO**  
(in dotazione)

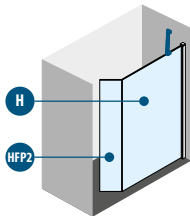

**KUADRA H  
KUADRA HFP2  
BARRA ORIENTABILE**

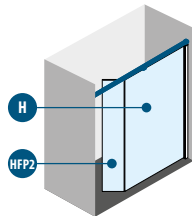

**KUADRA H  
KUADRA HFP2  
BARRA EVO (in nicchia)**

## KUADRA H+HFP2 VERSIONE AD ANGOLO

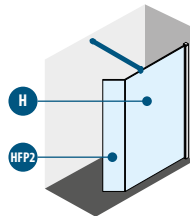

**KUADRA H  
KUADRA HFP2  
BARRA DI SOSTEGNO**  
(in dotazione)

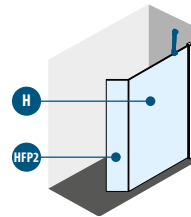

**KUADRA H  
KUADRA HFP2  
BARRA ORIENTABILE**

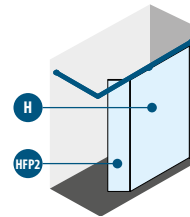

**KUADRA H  
KUADRA HFP2  
BARRA EVO (ad angolo)**

## KUADRA H+H VERSIONE AD ANGOLO

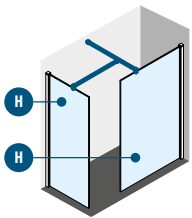

**KUADRA H x2  
BARRA DI SOSTEGNO**  
(in dotazione)

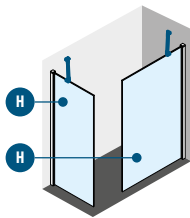

**KUADRA H x2  
BARRA ORIENTABILE**

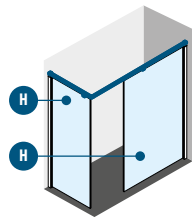

**KUADRA H x2  
BARRA EVO (ad angolo)**

## KUADRA H4 VERSIONE A CENTRO PARETE

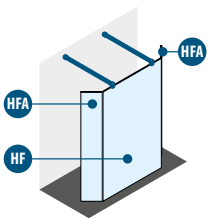

**KUADRA HF  
KUADRA HFA x2  
BARRA DI SOSTEGNO**  
(in dotazione)

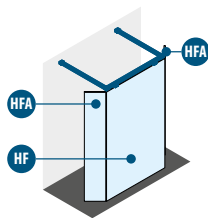

**KUADRA HF  
KUADRA HFA x2  
BARRA EVO (a U)**

## KUADRA H4 VERSIONE IN NICCHIA

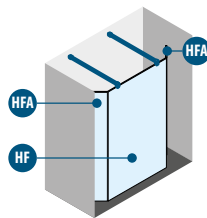

**KUADRA HF  
KUADRA HFA x2  
BARRA DI SOSTEGNO**  
(in dotazione)

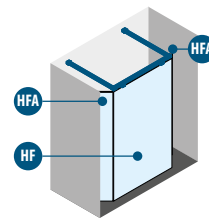

**KUADRA HF  
KUADRA HFA x2  
BARRA EVO (a U)**

## KUADRA H5 VERSIONE A CENTRO PARETE

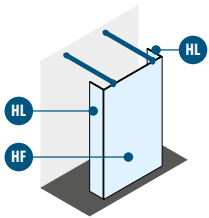

**KUADRA HF  
KUADRA HL x2  
BARRA DI SOSTEGNO**  
(in dotazione)

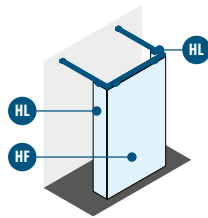

**KUADRA HF  
KUADRA HL x2  
BARRA DI SOSTEGNO**  
(in dotazione)

## KUADRA H5 VERSIONE IN NICCHIA

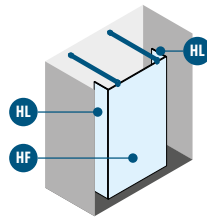

**KUADRA HF  
KUADRA HL x2  
BARRA DI SOSTEGNO**  
(in dotazione)

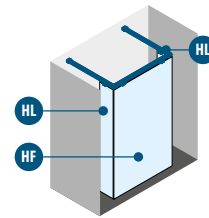

**KUADRA HF  
KUADRA HL x2  
BARRA DI SOSTEGNO**  
(in dotazione)

## COMBINAZIONI

### KUADRA H6 VERSIONE IN NICCHIA

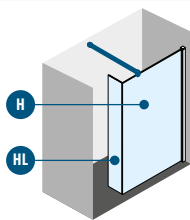

KUADRA H  
KUADRA HL  
BARRA DI SOSTEGNO  
(in dotazione)

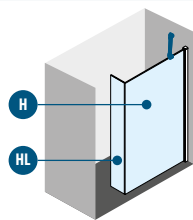

KUADRA H  
KUADRA HL  
BARRA ORIENTABILE

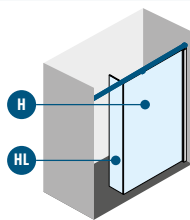

KUADRA H  
KUADRA HL  
BARRA EVO (in nicchia)

### KUADRA H6 VERSIONE AD ANGOLO

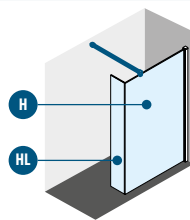

KUADRA H  
KUADRA HL  
BARRA DI SOSTEGNO  
(in dotazione)

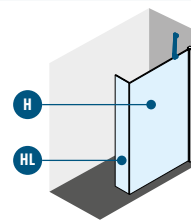

KUADRA H  
KUADRA HL  
BARRA ORIENTABILE

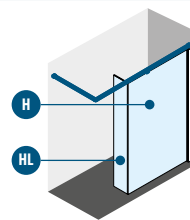

KUADRA H  
KUADRA HL  
BARRA EVO (ad angolo)

### KUADRA H7 VERSIONE AD ANGOLO

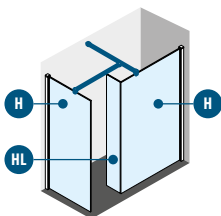

KUADRA H x2  
KUADRA HL  
BARRA DI SOSTEGNO  
(in dotazione)

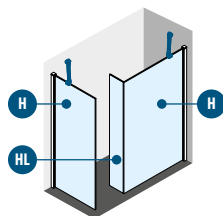

KUADRA H x2  
KUADRA HL  
BARRA ORIENTABILE

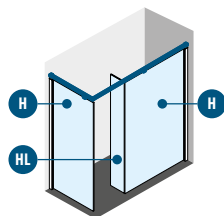

KUADRA H x2  
KUADRA HL  
BARRA EVO (ad angolo)

### KUADRA H9 VERSIONE A CENTRO PARETE

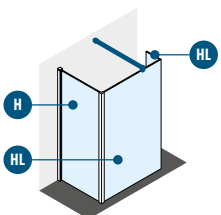

KUADRA HL x2  
KUADRA H  
BARRA DI SOSTEGNO  
(in dotazione)

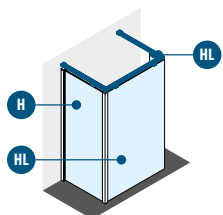

KUADRA HL x2  
KUADRA H  
BARRA EVO (a U)

### KUADRA H9 VERSIONE AD ANGOLO

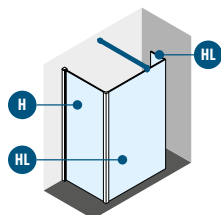

KUADRA HL x2  
KUADRA H  
BARRA DI SOSTEGNO  
(in dotazione)

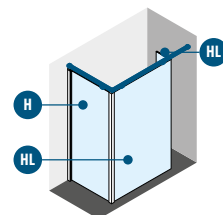

KUADRA HL x2  
KUADRA H  
BARRA EVO (ad angolo)

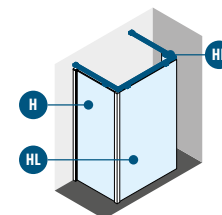

KUADRA HL x2  
KUADRA H  
BARRA EVO (a U)

## BARRA DI SOSTEGNO STANDARD (IN DOTAZIONE)



BARRA DI SOSTEGNO  
100 cm

## MISURE DI INGOMBRO PROFILI DI FISSAGGIO

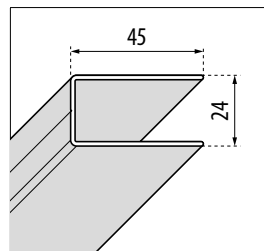

### A MURO

Finitura	Codice
Bianco	<b>P01KUHST-A</b>
Silver	<b>P01KUHST-B</b>
Cromo	<b>P01KUHST-K</b>
Nero	<b>P01KUHST-H</b>
Inox	<b>P01KUHST-Z</b>

PER TUTTE LE ALTRE BARRE DI SOSTEGNO - VEDI PAG. 316



## DATI TECNICI

### FINITURE PROFILI



Bianco opaco  
cod. U



Silver  
cod. B



Cromo  
cod. K



Nero opaco  
cod. H

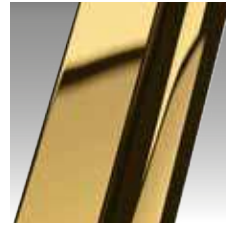

Oro  
lucido  
cod. O



Oro rosa  
lucido  
cod. M



Cromo  
nero lucido  
cod. L

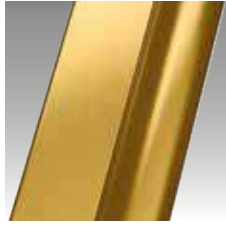

Oro  
spazzolato  
cod. P



Oro rosa  
spazzolato  
cod. R



Cromo  
nero spazzolato  
cod. N

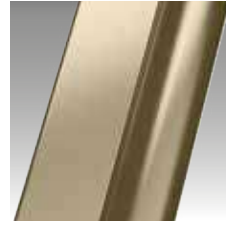

Bronzo  
spazzolato  
cod. Q



Inox  
spazzolato  
cod. Z

### VETRO TEMPRATO 8 mm (European Standards EN 14428)



Trasparente  
cod. 1



Specchio (SPY)  
cod. 76



Fumé  
cod. 54

### SERIGRAFIA



Ravenna  
cod. 51



Squares  
cod. 81



Stripes  
cod. 82



Frame  
cod. 86



Wires  
cod. 84

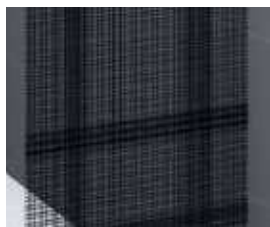

Plaid  
cod. 85



Banda black  
cod. 87



Banda Satin  
cod. 44

# KUADRA H FRAME



◀ Portasalviette esterno

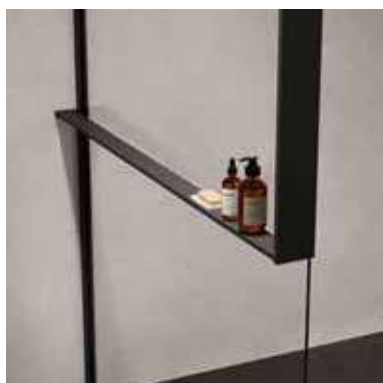

◀ Mensola porta oggetti



◀ Porta salviette e mensola porta oggetti



Frame è la soluzione total bathroom perfetta per un concept a 360° in cui mobili, lavabi, vasche, spazi doccia e accessori si coordinano interamente in uno stile d'avanguardia. Un progetto unico, un'unica azienda, per un tocco unico.

## TRATTAMENTI





# KUADRA H FRAME

# KUADRA H KIT FRAME

CON PORTASALVIETTE ESTERNO CON FISSAGGIO A PARETE

DA ORDINARE IN AGGIUNTA AD UN KUADRA H FINO ALLA LARGHEZZA MASSIMA 180 CM

Misure	Codice	Installazione		Scelta finitura / Prezzo					
		Destra	Sinistra	U	B	H	K	O M L	P R Q N Z
		D-	S-	Bianco opaco	Silver	Nero opaco	Cromo	Oro lucido Oro rosa lucido Cromo nero lucido	Oro spazzolato Oro rosa spazzolato Bronzo spazzolato Cromo nero spazzolato Inox Spazzolato
Max 140	<b>R80KUFRE10</b>			574 €	632 €	697 €	697 €	907 €	837 €
Max 180	<b>R80KUFRE1018</b>			632 €	694 €	769 €	769 €	1.000 €	923 €

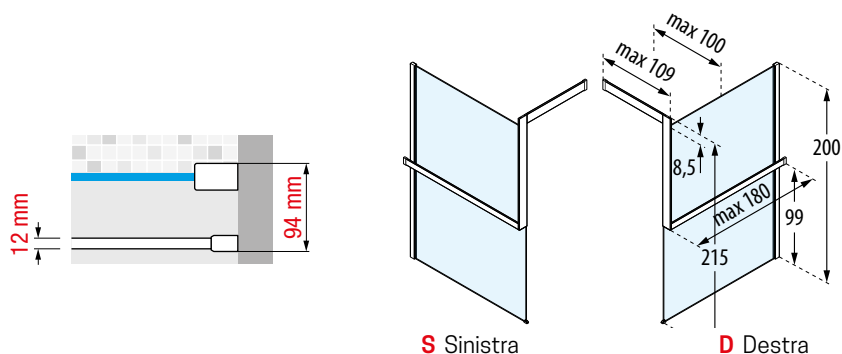

## PORTASALVIETTE ESTERNO CON FISSAGGIO A SOFFITTO

Misure	Codice	Installazione		Scelta finitura / Prezzo					
		Destra	Sinistra	U	B	H	K	O M L	P R Q N Z
		D-	S-	Bianco opaco	Silver	Nero opaco	Cromo	Oro lucido Oro rosa lucido Cromo nero lucido	Oro spazzolato Oro rosa spazzolato Bronzo spazzolato Cromo nero spazzolato Inox Spazzolato
Max 140	<b>R80KUFRESOF</b>			509 €	562 €	619 €	619 €	805 €	743 €
Max 180	<b>R80KUFRESOF18</b>			563 €	619 €	682 €	682 €	887 €	819 €

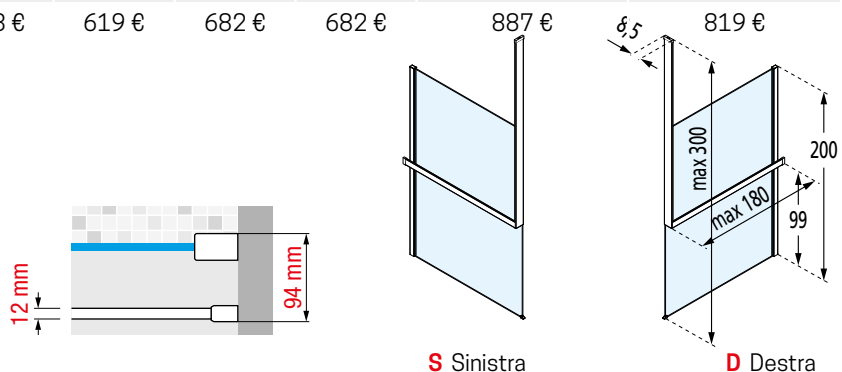



**FINITURE VETRI**



Trasparente  
**cod. 1**

**FINITURE PROFILI**



Bianco opaco  
**cod. U**

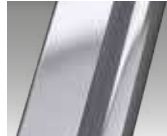

Silver  
**cod. B**



Cromo  
**cod. K**

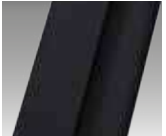

Nero opaco  
**cod. H**

**FINITURE PROFILI "COLORATISSIMI 1985-2023"**

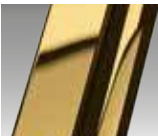

Oro lucido  
**cod. O**



Oro rosa lucido  
**cod. M**



Cromo nero lucido  
**cod. L**

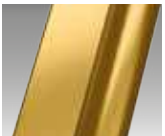

Oro spazzolato  
**cod. P**

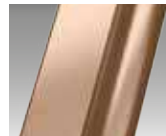

Oro rosa spazzolato  
**cod. R**

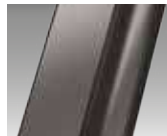

Cromo nero spazzolato  
**cod. N**

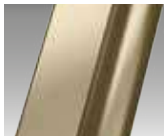

Bronzo spazzolato  
**cod. Q**



Inox spazzolato  
**cod. Z**

# KUADRA H KIT FRAME

## MENSOLA PORTA OGGETTI INTERNA CON FISSAGGIO A PARETE

DA ORDINARE IN AGGIUNTA AD UN KUADRA H FINO ALLA LARGHEZZA MASSIMA 165 CM

Codice	Installazione		Scelta finitura / Prezzo			
	Destra	Sinistra	U	B	H	P R Q N Z
	D-	S-	Bianco opaco	Silver	Nero opaco	Oro spazzolato Oro rosa spazzolato Bronzo spazzolato Cromo nero spazzolato Inox Spazzolato
<b>R80KUFRI10</b>			535 €	593 €	658 €	790 €

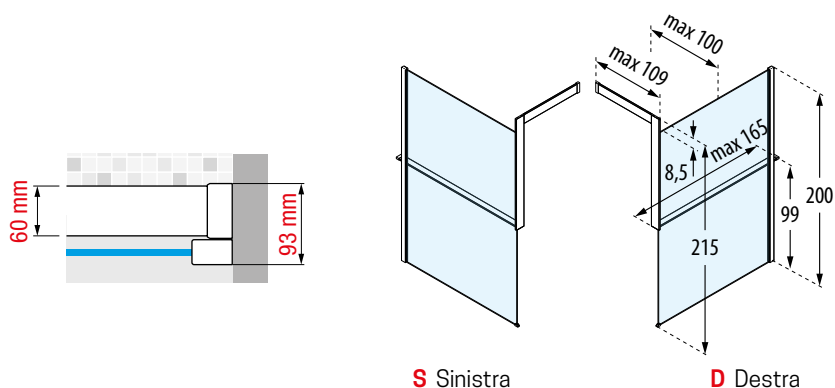

## MENSOLA PORTA OGGETTI INTERNA CON FISSAGGIO A SOFFITTO

Codice	Installazione		Scelta finitura / Prezzo			
	Destra	Sinistra	U	B	H	P R Q N Z
	D-	S-	Bianco opaco	Silver	Nero opaco	Oro spazzolato Oro rosa spazzolato Bronzo spazzolato Cromo nero spazzolato Inox Spazzolato
<b>R80KUFRI10</b>			470 €	523 €	580 €	696 €

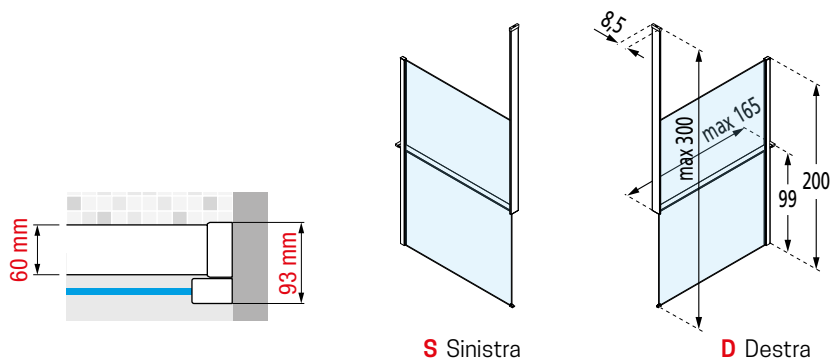



**FINITURE VETRI**



Trasparente  
**cod 1**

**FINITURE PROFILI**



Bianco opaco  
**cod U**



Silver  
**cod B**

**FINITURE PROFILI "COLORATISSIMI 1985-2023"**

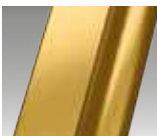

Oro spazzolato  
**cod. P**

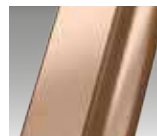

Oro rosa spazzolato  
**cod. R**

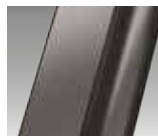

Cromo nero spazzolato  
**cod. N**

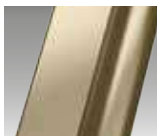

Bronzo spazzolato  
**cod. Q**



Inox spazzolato  
**cod. Z**

# KUADRA HF FRAME

## CON PORTA SALVIETTE



Misure	Codice	Scelta vetro	Scelta profilo						
Misura effettiva d'ingombro		1	U	B	K	H	O M L	P R Q N Z	
<b>A</b>		Trasparente	Bianco opaco	Silver	Cromo	Nero opaco	Oro lucido Oro rosa lucido Cromo nero lucido	Oro spazzolato Oro rosa spazzolato Bronzo spazzolato Cromo nero spazzolato Inox	
114	<b>KUADFC116PS-</b>		1.238 €	1.363 €	1.519 €	1.519 €	1.975 €	1.823 €	
134	<b>KUADFC136PS-</b>		1.307 €	1.438 €	1.600 €	1.600 €	2.080 €	1.920 €	
154	<b>KUADFC156PS-</b>		1.363 €	1.500 €	1.669 €	1.669 €	2.170 €	2.003 €	

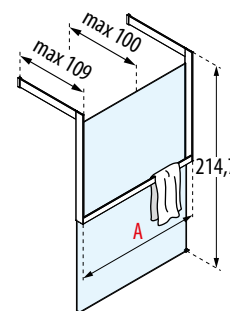

## CON MENSOLA PORTA OGGETTI



Misure	Codice	Scelta vetro	Scelta profilo				
Misura effettiva d'ingombro		1	U	B	H	P R Q N Z	
<b>A</b>		Trasparente	Bianco opaco	Silver	Nero opaco	Oro spazzolato Oro rosa spazzolato Bronzo spazzolato Cromo nero spazzolato Inox	
114	<b>KUADFC116PO-</b>		1.200 €	1.325 €	1.475 €	1.770 €	
134	<b>KUADFC136PO-</b>		1.269 €	1.400 €	1.557 €	1.869 €	
154	<b>KUADFC156PO-</b>		1.325 €	1.463 €	1.625 €	1.950 €	

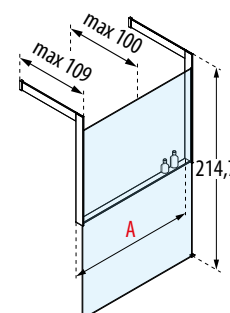





Il trinomio finitura, funzione e forma, "must have" imprescindibile per Novellini, trova massima espressione nella linea **FRAME**. L'elemento in alluminio incornicia la parete in vetro e funge da accessorio porta salviette o mensola porta oggetti.

**FINITURE VETRI**



Trasparente  
**cod. 1**

**FINITURE PROFILI**



Bianco opaco  
**cod. U**



Silver  
**cod. B**



Cromo  
**cod. K**



Nero opaco  
**cod. H**

**FINITURE PROFILI "COLORATISSIMI 1985-2023"**

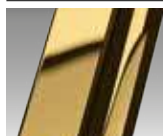

Oro lucido \*  
**cod. O**



Oro rosa lucido \*  
**cod. M**



Cromo nero  
lucido \*  
**cod. L**

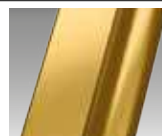

Oro  
spazzolato  
**cod. P**

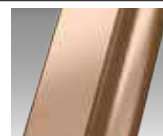

Oro rosa  
spazzolato  
**cod. R**

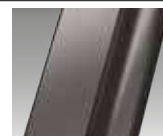

Cromo nero  
spazzolato  
**cod. N**

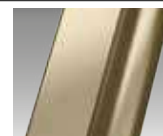

Bronzo  
spazzolato  
**cod. Q**

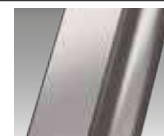

Inox  
spazzolato  
**cod. Z**

\* solo per versione con porta salviette esterno

# KUADRA HN FRAME

PARETE FISSA VERSIONE IN NICCHIA



200 cm



8 mm



3 cm



## FINITURE VETRI

Trasparente  
cod. 1

## FINITURE PROFILI

Bianco opaco  
cod. U

Silver  
cod. B

Cromo  
cod. K

Nero opaco  
cod. H

## COLORATISSIMI

Oro lucido  
cod. O

Oro rosa  
lucido  
cod. M

Cromo nero  
lucido  
cod. L

Oro spazzolato  
cod. P

Oro rosa  
spazzolato  
cod. R

Cromo nero  
spazzolato  
cod. N

Bronzo  
spazzolato  
cod. Q

Inox  
spazzolato  
cod. Z



Misure				Codice	Installazione		Scelta vetro	Scelta profilo							
Misura effettiva d'ingombro	Misura fisso frontale	Spazio di entrata (cm)	Dimensioni piatto		Destra	Sinistra		U	B	K	H	O M L	P R Q N Z		
A	F	*			D-	S-	1								
117↔120	57	63	120	<b>KUADHN120</b>	D-	S-	Trasparente	644 €	713 €	794 €	794 €	1.033 €	953 €		
137↔140	77	63	140	<b>KUADHN140</b>	D-	S-		688 €	763 €	850 €	850 €	1.105 €	1.020 €		
147↔150	87	63	150	<b>KUADHN150</b>	D-	S-		700 €	775 €	863 €	863 €	1.122 €	1.036 €		
157↔160	97	63	160	<b>KUADHN160</b>	D-	S-		713 €	788 €	875 €	875 €	1.138 €	1.050 €		
167↔170	107	63	170	<b>KUADHN170</b>	D-	S-		757 €	838 €	932 €	932 €	1.212 €	1.119 €		
177↔180	117	63	180	<b>KUADHN180</b>	D-	S-		769 €	850 €	950 €	950 €	1.235 €	1.140 €		

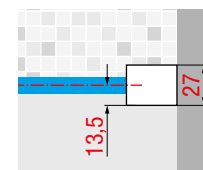
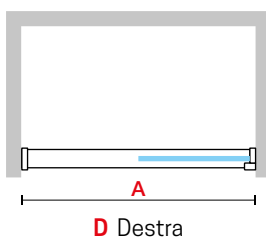
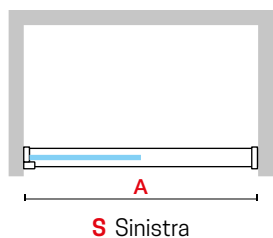
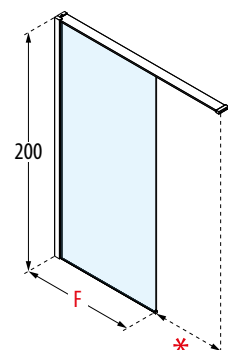

OPTIONAL

# KUADRA H FRAME PORTA SALVIETTE

PORTA SALVIETTE ESTERNO

INSTALLABILE SOLO A PAVIMENTO - DA ORDINARE IN AGGIUNTA AD UN KUADRA H / HN FRAME



Misure	Codice	Installazione		Scelta profilo			
		Destra	Sinistra	U	B	K	H
		D-	S-				
Misura effettiva d'ingombro				Bianco opaco	Silver	Cromo	Nero opaco
<b>A</b>							
117	<b>R90AKFBPS</b>	D-	S-	294 €	319 €	350 €	350 €
157	<b>R90AKFBPS16</b>	D-	S-	325 €	357 €	388 €	388 €

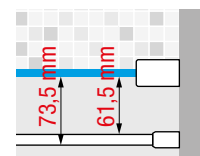
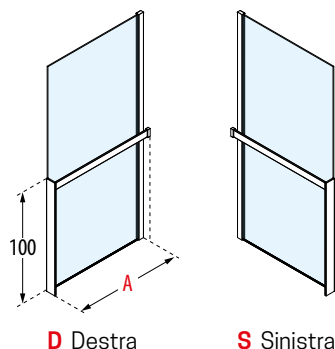

FRAME COLLECTION

OPTIONAL

# KUADRA H FRAME MENSOLA

MENSOLA PORTA OGGETTI

DA ORDINARE IN AGGIUNTA AD UN KUADRA H / HN FRAME



Misure	Codice	Installazione		Scelta profilo		
		Destra	Sinistra	U	B	H
		D-	S-			
Misura effettiva d'ingombro				Bianco opaco	Silver	Nero opaco
<b>A</b>						
117	<b>R90AKFBPO</b>	D-	S-	294 €	319 €	350 €
157	<b>R90AKFBPO16</b>	D-	S-	325 €	357 €	388 €

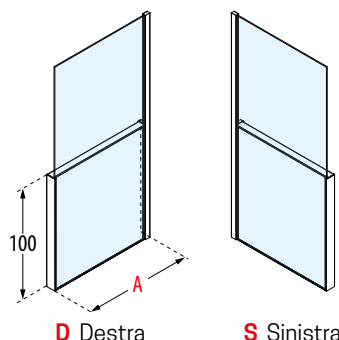

Dettaglio del sistema di appoggio al piatto doccia. Disponibile bianco e nero

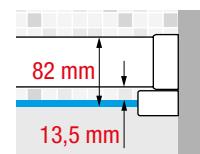

Costruzione del codice

Codice

+

Sinistra/Destra

+

Vetro

+

Profilo

= Codice prodotto finale

OPTIONAL

# KUADRA HD FRAME

KIT BARRA FRAME PORTA-SALVIETTE ESTERNO + MENSOLA INTERNA

DA ORDINARE IN AGGIUNTA AD UN KUADRA H / HN FRAME



## FINITURE PROFILI



Bianco opaco  
cod. U



Silver  
cod. B



Nero opaco  
cod. H

## COLORATISSIMI



Oro spazzolato  
cod. P



Oro rosa spazzolato  
cod. R



Cromo nero spazzolato  
cod. N



Bronzo spazzolato  
cod. Q



Inox spazzolato  
cod. Z

Misure	Codice	Installazione		Scelta finitura / Prezzo			
		Destra	Sinistra	U	B	H	P R Q N Z
		D-	S-				
Per pareti fino a 120	<b>R80KUFRHD12</b>			Bianco opaco	Silver	Nero opaco	Oro spazzolato Oro rosa spazzolato Bronzo spazzolato Cromo nero spazzolato Inox Spazzolato
Per pareti da 130 a 180	<b>R80KUFRHD18</b>			355 €	355 €	390 €	510 €
				391 €	391 €	429 €	569 €

## INSTALLAZIONE SENZA BARRA DI SOSTEGNO FINO A MAX 120 CM

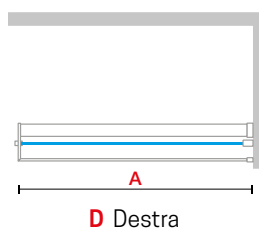
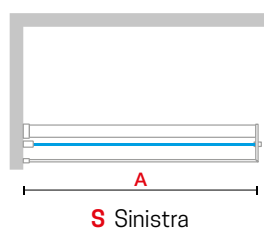
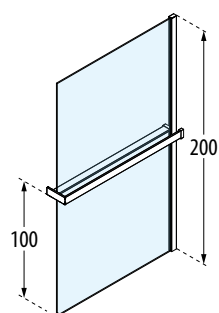

# KUADRA HWL FRAME

2 MENSOLE PORTA OGGETTI INTERNE



200 cm



8 mm



3 cm



## FINITURE VETRI



Trasparente  
cod. 1

## FINITURE PROFILI



Bianco opaco  
cod. U



Silver  
cod. B



Nero opaco  
cod. H



Misure		Codice	Installazione		Scelta vetro	Scelta profilo		
Misura effettiva d'ingombro	Dimensioni piatto		Destra	Sinistra		U	B	H
<b>A</b>	<b>AxB ± 2 mm</b>		<b>D-</b>	<b>S-</b>	<b>1</b>			
					Trasparente	Bianco opaco	Silver	Nero opaco
135↔138	<b>140</b>	<b>KUADHWLPO0140</b>	D-	S-		1.762 €	1.938 €	2.132 €
145↔148	<b>150</b>	<b>KUADHWLPO0150</b>	D-	S-		1.784 €	1.963 €	2.159 €
155↔158	<b>160</b>	<b>KUADHWLPO0160</b>	D-	S-		1.829 €	2.013 €	2.214 €
165↔168	<b>170</b>	<b>KUADHWLPO0170</b>	D-	S-		1.852 €	2.038 €	2.242 €
175↔178	<b>180</b>	<b>KUADHWLPO0180</b>	D-	S-		1.875 €	2.063 €	2.269 €
195↔198	<b>200</b>	<b>KUADHWLPO0200</b>	D-	S-		1.898 €	2.088 €	2.297 €
215↔218	<b>220</b>	<b>KUADHWLPO0220</b>	D-	S-		1.932 €	2.125 €	2.338 €

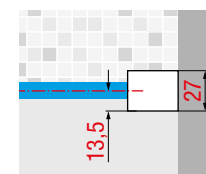
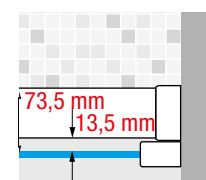
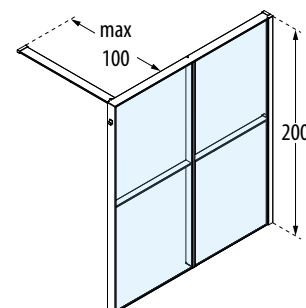

Dettaglio del sistema di appoggio al piatto doccia. Disponibile bianco e nero

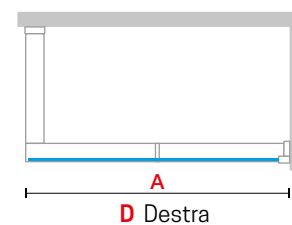
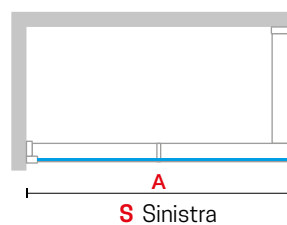

Costruzione del codice + Codice del codice = Codice prodotto finale

# KUADRA **HWS** CON PORTA SALVIETTE



200 cm



5 mm



3 cm

## PARETE FISSA CON PORTA SALVIETTE ESTERNO

INSTALLABILE SOLO A PAVIMENTO



### FINITURE VETRI



Trasparente  
cod. 1

### FINITURE PROFILI



Bianco opaco  
cod. U



Silver  
cod. B



Nero opaco  
cod. H

Misure	Codice	Installazione		Scelta vetro	Scelta profilo		
		Destra	Sinistra		U	B	H
Misura effettiva d'ingombro		D-	S-	1			
<b>A</b>				Trasparente	Bianco opaco	Silver	Nero opaco
77↔80	<b>KUADHWSPS80</b>	D-	S-		1.129 €	1.228 €	1.347 €
87↔90	<b>KUADHWSPS90</b>	D-	S-		1.129 €	1.228 €	1.347 €
97↔100	<b>KUADHWSPS100</b>	D-	S-		1.129 €	1.228 €	1.347 €
107↔110	<b>KUADHWSPS110</b>	D-	S-		1.189 €	1.294 €	1.418 €
117↔120	<b>KUADHWSPS120</b>	D-	S-		1.202 €	1.307 €	1.432 €
127↔130	<b>KUADHWSPS130</b>	D-	S-		1.274 €	1.379 €	1.504 €
137↔140	<b>KUADHWSPS140</b>	D-	S-		1.274 €	1.379 €	1.504 €

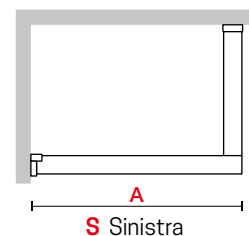
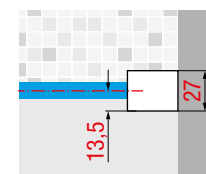
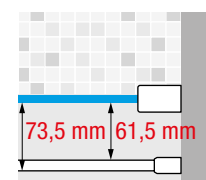
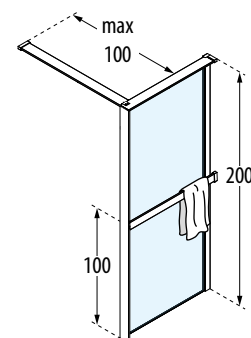

S Sinistra

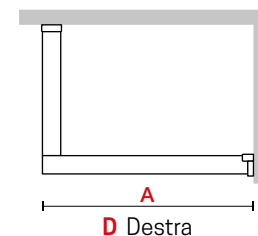

D Destra



# KUADRA HWS CON MENSOLA

PARETE FISSA CON MENSOLA PORTA OGGETTI INTERNA



200 cm



8 mm



3 cm



## FINITURE VETRI



Trasparente  
cod. 1

## FINITURE PROFILI



Bianco opaco  
cod. U



Silver  
cod. B



Nero opaco  
cod. H

Misure	Codice	Installazione		Scelta vetro	Scelta profilo		
		Destra	Sinistra		U	B	H
Misura effettiva d'ingombro		D-	S-	1			
<b>A</b>				Trasparente	Bianco opaco	Silver	Nero opaco
77↔80	<b>KUADHWSP080</b>	D-	S-		1.129 €	1.228 €	1.347 €
87↔90	<b>KUADHWSP090</b>	D-	S-		1.129 €	1.228 €	1.347 €
97↔100	<b>KUADHWSP0100</b>	D-	S-		1.129 €	1.228 €	1.347 €
107↔110	<b>KUADHWSP0110</b>	D-	S-		1.189 €	1.294 €	1.418 €
117↔120	<b>KUADHWSP0120</b>	D-	S-		1.202 €	1.307 €	1.432 €
127↔130	<b>KUADHWSP0130</b>	D-	S-		1.274 €	1.379 €	1.504 €
137↔140	<b>KUADHWSP0140</b>	D-	S-		1.274 €	1.379 €	1.504 €

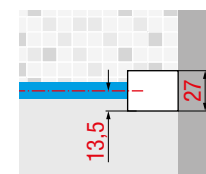
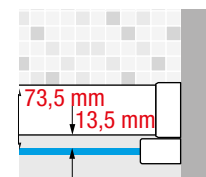
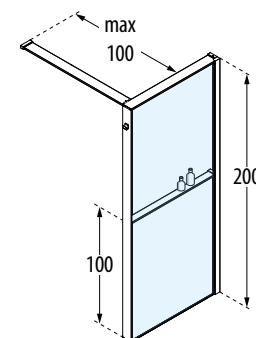

Dettaglio del sistema di appoggio al piatto doccia. Disponibile bianco e nero

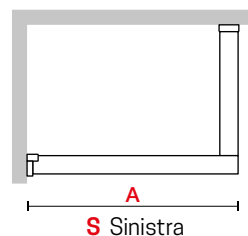

S Sinistra

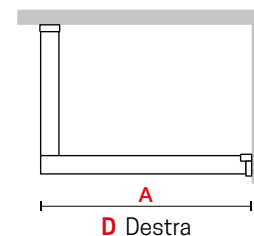

D Destra

Costruzione del codice

Codice

+ Destra/Sinistra

+ Vetro

+ Profilo

= Codice prodotto finale

# KUADRA HWZ1 FRAME



1 MENSOLA PORTA OGGETTI INTERNA + 1 PORTA SALVIETTE SUL LATO MURO

INSTALLABILE SOLO A PAVIMENTO



## FINITURE VETRI



## FINITURE PROFILI



Misure	Codice	Installazione		Scelta vetro	Scelta profilo			
		Destra	Sinistra		1	U	B	H
Misura effettiva d'ingombro		D-	S-	1	U	B	H	
<b>A</b>				Trasparente	Bianco opaco	Silver	Nero opaco	

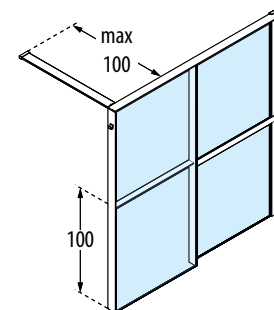

LATO INGRESSO PORTA OGGETTI-PORTA SALVIETTE							
134↔137	<b>KUADHWZPOS140</b>	D-	S-		1.784 €	1.963 €	2.159 €
144↔147	<b>KUADHWZPOS150</b>	D-	S-		1.807 €	1.988 €	2.187 €
154↔157	<b>KUADHWZPOS160</b>	D-	S-		1.852 €	2.038 €	2.242 €
164↔167	<b>KUADHWZPOS170</b>	D-	S-		1.875 €	2.063 €	2.269 €
174↔177	<b>KUADHWZPOS180</b>	D-	S-		1.898 €	2.088 €	2.297 €
194↔197	<b>KUADHWZPOS200</b>	D-	S-		1.920 €	2.113 €	2.324 €
214↔217	<b>KUADHWZPOS220</b>	D-	S-		1.954 €	2.150 €	2.365 €

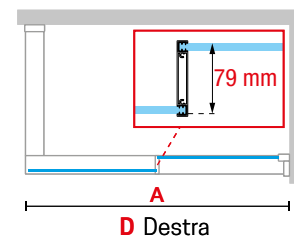
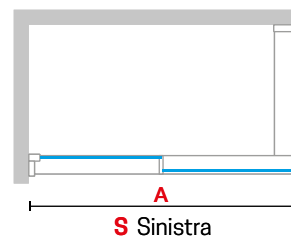
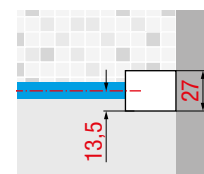
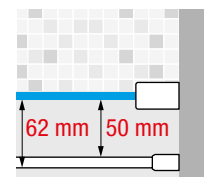



# KUADRA HWZ2 FRAME



200 cm



8 mm



3 cm



**1 MENSOLA PORTA OGGETTI INTERNA + 1 PORTA SALVIETTE SUL LATO INGRESSO**

**INSTALLABILE SOLO A PAVIMENTO**



## FINITURE VETRI



Trasparente  
cod. 1

## FINITURE PROFILI



Bianco opaco  
cod. U



Silver  
cod. B



Nero opaco  
cod. H



Misure	Codice	Installazione		Scelta vetro	Scelta profilo		
		Destra	Sinistra		1	U	B
Misura effettiva d'ingombro		D-	S-	1	U	B	H
<b>A</b>				Trasparente	Bianco opaco	Silver	Nero opaco

### LATO INGRESSO PORTA SALVIETTE-PORTA OGGETTI

134↔137	<b>KUADHWZPS0140</b>	D-	S-	1.784 €	1.963 €	2.159 €
144↔147	<b>KUADHWZPS0150</b>	D-	S-	1.807 €	1.988 €	2.187 €
154↔157	<b>KUADHWZPS0160</b>	D-	S-	1.852 €	2.038 €	2.242 €
164↔167	<b>KUADHWZPS0170</b>	D-	S-	1.875 €	2.063 €	2.269 €
174↔177	<b>KUADHWZPS0180</b>	D-	S-	1.898 €	2.088 €	2.297 €
194↔197	<b>KUADHWZPS0200</b>	D-	S-	1.920 €	2.113 €	2.324 €
214↔217	<b>KUADHWZPS0220</b>	D-	S-	1.954 €	2.150 €	2.365 €

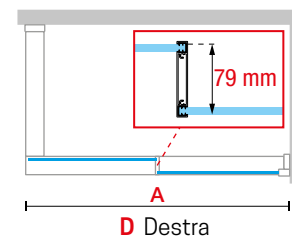
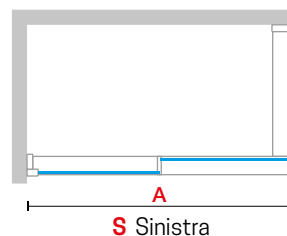
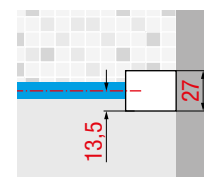
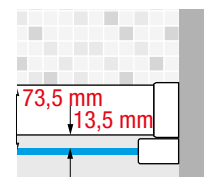
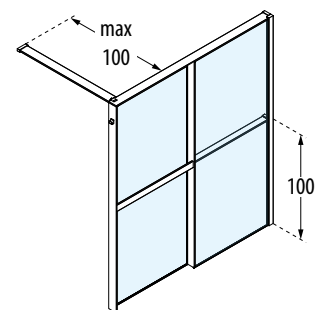

Costruzione del codice

Codice

+ Destra/Sinistra

+ Vetro

+ Profilo

= Codice prodotto finale

# KUADRA H IN-ART

PARETE FISSA



200 cm



8 mm



3 cm



## FINITURE PROFILI



Bianco opaco  
cod U

Silver  
cod B



Cromo  
cod K

Nero  
cod H



Inox  
cod Z

Misure	Codice	Destra	Sinistra	Scelta decoro	Scelta profilo				
Misura effettiva d'ingombro		D-	S-	*	U	B	K	H	Z
<b>A</b>					Bianco opaco	Silver	Cromo	Nero opaco	Inox
67↔70	<b>KUADH70</b>			Codice decoro da pag. 291 a pag. 293	1.132 €	1.182 €	1.238 €	1.238 €	1.393 €
72↔75	<b>KUADH75</b>				1.132 €	1.182 €	1.238 €	1.238 €	1.393 €
77↔80	<b>KUADH80</b>				1.200 €	1.250 €	1.307 €	1.307 €	1.462 €
87↔90	<b>KUADH90</b>				1.300 €	1.350 €	1.407 €	1.407 €	1.562 €
97↔100	<b>KUADH100</b>				1.300 €	1.350 €	1.407 €	1.407 €	1.562 €
107↔110	<b>KUADH110</b>				1.357 €	1.413 €	1.475 €	1.475 €	1.630 €
117↔120	<b>KUADH120</b>				1.457 €	1.513 €	1.575 €	1.575 €	1.730 €
127↔130	<b>KUADH130</b>				1.525 €	1.582 €	1.644 €	1.644 €	1.799 €
137↔140	<b>KUADH140</b>				1.525 €	1.582 €	1.644 €	1.644 €	1.799 €

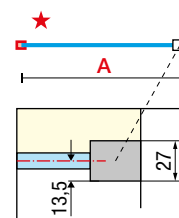
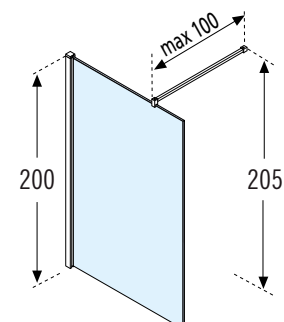

**DI SERIE, BARRA DI SOSTEGNO DA 100 CM  
LA BARRA DI SOSTEGNO DA 150 CM È OPTIONAL  
(VEDI PAG. 316)**

**In Art è un prodotto realizzato con colore fatto in polvere di vetro quindi la definizione non è di tipo fotografico e può essere soggetta a piccole variazioni cromatiche e di risoluzione**

- Non sono disponibili misure speciali

- A richiesta, previa accettazione scritta di fattibilità da parte dell'azienda, è possibile realizzare immagini personalizzate solo su articoli di misure standard, con aumento di listino di 625 Euro Lordi

Piedini di fissaggio al pavimento



# KUADRA FC IN-ART

FISSO CENTRALE



200 cm



8 mm



3 cm



## FINITURE PROFILI



Bianco  
cod A



Silver  
cod B



Cromo  
cod K



Nero  
cod H



Inox  
cod Z

KUADRA H IN ART

Misure	Codice	Scelta decoro	Scelta profilo				
Misura effettiva d'ingombro		*	U	B	K	H	Z
<b>C</b>			Bianco opaco	Silver	Cromo	Nero opaco	Inox
94	<b>KUADFC96-</b>	Codice decoro da pag. 291 a pag. 293	1.357 €	1.413 €	1.475 €	1.475 €	1.630 €
114	<b>KUADFC116-</b>		1.482 €	1.538 €	1.600 €	1.600 €	1.755 €
134	<b>KUADFC136-</b>		1.532 €	1.588 €	1.650 €	1.650 €	1.805 €
154	<b>KUADFC156-</b>		1.569 €	1.632 €	1.700 €	1.700 €	1.855 €

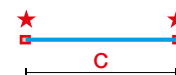
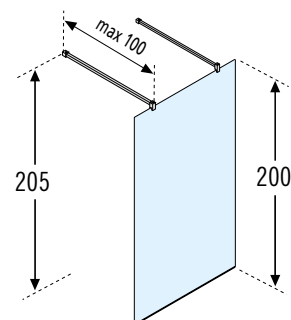

**DI SERIE, BARRA DI SOSTEGNO DA 100 CM  
LA BARRA DI SOSTEGNO DA 150 CM È OPTIONAL  
(VEDI PAG. 316)**

**In Art è un prodotto realizzato con colore fatto in polvere di vetro quindi la definizione non è di tipo fotografico e può essere soggetta a piccole variazioni cromatiche e di risoluzione**

- Non sono disponibili misure speciali
- A richiesta, previa accettazione scritta di fattibilità da parte dell'azienda, è possibile realizzare immagini personalizzate solo su articoli di misure standard, con aumento di listino di 625 Euro Lordi

Piedini di fissaggio al pavimento



Costruzione del codice **Codice** + **Vetro** + **Profilo** = Codice prodotto finale

# KUADRA HL

FISSO LATERALE PER KUADRA H



## FINITURE VETRI

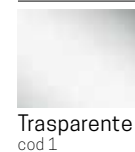

## FINITURE PROFILI

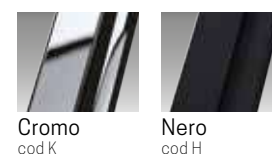

Misure	Codice	Scelta vetro	Scelta profilo				
Misura effettiva d'ingombro		1	U	B	K	H	Z
<b>PARETE</b>							
<b>D</b>		Trasparente	Bianco opaco	Silver	Cromo	Nero opaco	Inox
68	<b>KUADHL70-</b>		413 €	457 €	513 €	513 €	668 €
78	<b>KUADHL80-</b>		438 €	482 €	538 €	538 €	693 €
88	<b>KUADHL90-</b>		463 €	507 €	563 €	563 €	718 €
98	<b>KUADHL100-</b>		488 €	532 €	588 €	588 €	743 €
118	<b>KUADHL120-</b>		513 €	557 €	613 €	613 €	768 €
138	<b>KUADHL140-</b>		538 €	582 €	638 €	638 €	793 €
158	<b>KUADHL160-</b>		563 €	607 €	663 €	663 €	818 €
<b>ALETTA</b>							
<b>F</b>							
15	<b>KUADHL15-</b>		175 €	194 €	213 €	213 €	255 €
30	<b>KUADHL30-</b>		194 €	213 €	232 €	232 €	278 €
40	<b>KUADHL40-</b>		219 €	238 €	257 €	257 €	308 €

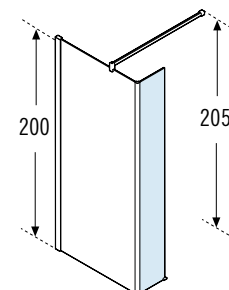
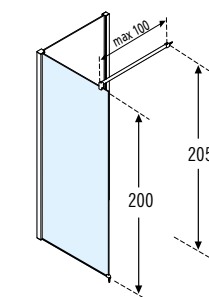

Piedini di fissaggio al pavimento

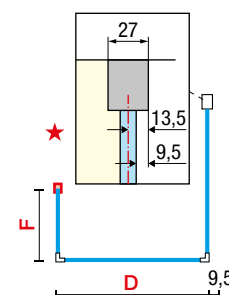

**DI SERIE, BARRA DI SOSTEGNO DA 100 CM  
LA BARRA DI SOSTEGNO DA 150 CM È OPTIONAL  
(VEDI PAG. 316)**



KUADRA H IN ART / **SCelta DEL DECORO**



KUADRA H IN ART

KUADRA H IN ART / **SCELTA DEL DECORO**

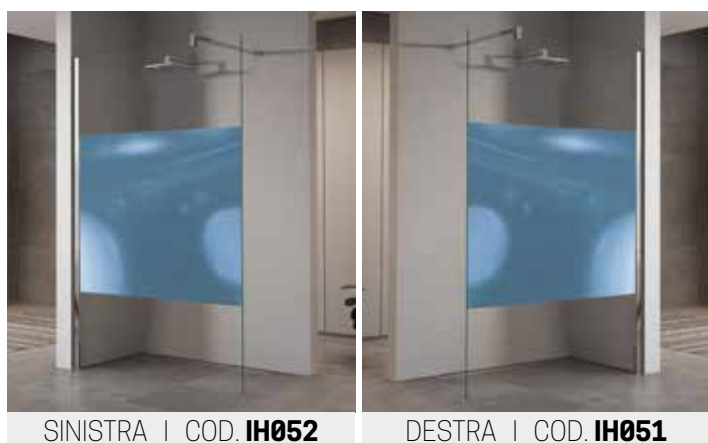

NON DISPONIBILE NELLE MISURE 70 - 75 - 80



SINISTRA | COD. **T0301**



DESTRA | COD. **TS301**



SINISTRA | COD. **R0091**



DESTRA | COD. **RS091**



SINISTRA | COD. **RS101**



DESTRA | COD. **R0101**

NON DISPONIBILE NELLE MISURE 70 - 75 - 80



SINISTRA | COD. **T0431**



DESTRA | COD. **T0431**

NON DISPONIBILE NELLE MISURE 70 - 75 - 80 - 90 - 100



SINISTRA | COD. **TS271**



DESTRA | COD. **T0271**

NON DISPONIBILE NELLE MISURE 70 - 75



SINISTRA | COD. **T0331**



DESTRA | COD. **T0331**



SINISTRA | COD. **A0051**



DESTRA | COD. **A0051**

# H STYLE

FLESSIBILITÀ

DELLO SPAZIO IN BAGNO



◀ Apertura porta, scorrimento su binario superiore



◀ Sistema di sganciamento della porta



◀ Carrello nascosto + fermo anta

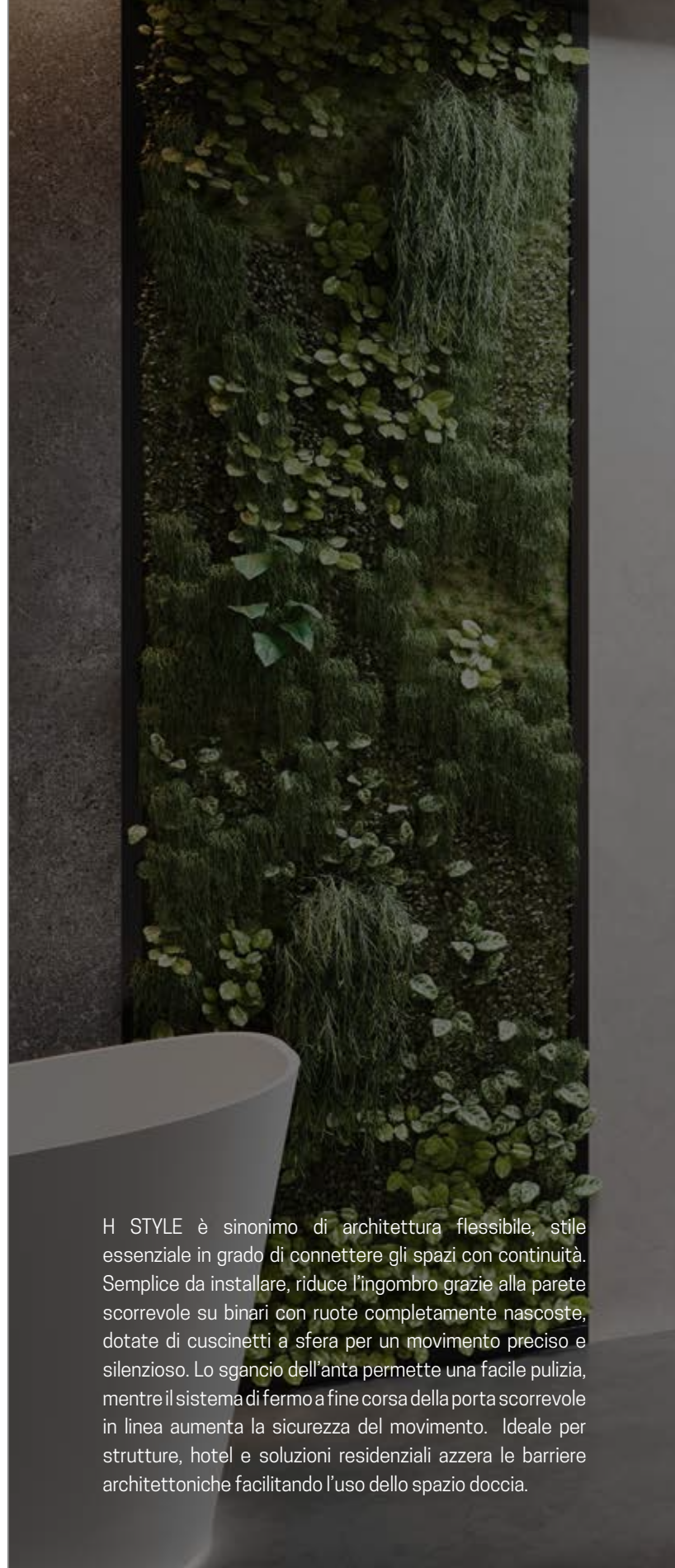

H STYLE è sinonimo di architettura flessibile, stile essenziale in grado di connettere gli spazi con continuità. Semplice da installare, riduce l'ingombro grazie alla parete scorrevole su binari con ruote completamente nascoste, dotate di cuscinetti a sfera per un movimento preciso e silenzioso. Lo sgancio dell'anta permette una facile pulizia, mentre il sistema di fermo a fine corsa della porta scorrevole in linea aumenta la sicurezza del movimento. Ideale per strutture, hotel e soluzioni residenziali azzera le barriere architettoniche facilitando l'uso dello spazio doccia.

## TRATTAMENTI







H STYLE

# H STYLE

# H STYLE



## PARETE FISSA IN LINEA CON 1 ANTA SCORREVOLE

Misure		Codice	Destra	Sinistra	Scelta vetro	Scelta profilo			
Misura effettiva d'ingombro						D-	S-	U	B
<b>A</b>	<b>F</b>				1	Bianco opaco	Silver	Cromo	Nero opaco
97↔99	51	<b>HSTYLE100</b>	D-	S-	Trasparente	1.045 €	1.150 €	1.265 €	1.265 €
117↔119	61	<b>HSTYLE120</b>	D-	S-		1.100 €	1.210 €	1.331 €	1.331 €
137↔139	71	<b>HSTYLE140</b>	D-	S-		1.155 €	1.271 €	1.399 €	1.399 €
157↔159	81	<b>HSTYLE160</b>	D-	S-		1.210 €	1.331 €	1.465 €	1.465 €
177↔179	91	<b>HSTYLE180</b>	D-	S-		1.265 €	1.392 €	1.532 €	1.532 €

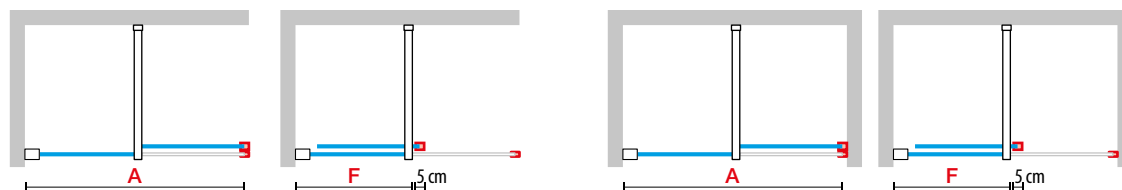
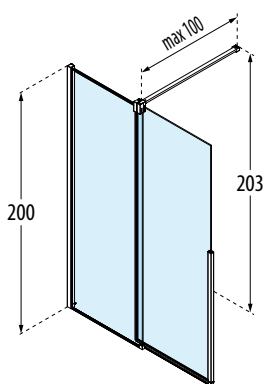



VERSIONE SINISTRA

**FINITURE VETRI**



Trasparente  
cod. 1

**FINITURE PROFILI**



Bianco opaco  
cod. U

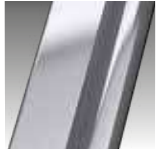

Silver  
cod. B



Cromo  
cod. K



Nero opaco  
cod. H

# HART

ARTIGIANALITÀ  
DELLO SPAZIO DOCCIA



◀ Nuova barra di sostegno



◀ Angolo profili  
con taglio a 45°



◀ Dettaglio giunzione



Lo spazio doccia si trasforma divenendo la base di partenza per riqualificare l'ambiente bagno con una progettazione che non si limita solo all'ideazione del prodotto ma affonda le radici nell'esperienza e nella competenza del design industriale di Novellini. Uno stile progettuale che non nasconde, ma si mostra ed esprime senza decorazioni superflue la subordinazione della forma all'onestà della funzione, donando all'ambiente bagno un aspetto in continua evoluzione.

Una vasta scelta di combinazioni tra vetri e colori profilo in grado di soddisfare anche la più avanzata delle personalizzazioni.

## TRATTAMENTI





HART

FLUTE / CROMO NERO LUCIDO

# HART



200 cm



6 mm



1,5 cm



Misure	Codice	Scelta vetro			Scelta profilo				
Misura effettiva d'ingombro		92	93	94	U	K	H	O M L	P R Q N Z
A		Linea 1	Linea 2	Flute	Bianco opaco	Cromo	Nero opaco	Oro lucido Oro rosa lucido Cromo nero lucido	Oro spazzolato Oro rosa spazzolato Bronzo spazzolato Cromo nero spazzolato Inox spazzolato
77↔78,5	<b>HARTHC80-</b>				989 €	1.180 €	1.180 €	1.380 €	1.320 €
87↔88,5	<b>HARTHC90-</b>				1.036 €	1.235 €	1.235 €	1.445 €	1.385 €
97↔98,5	<b>HARTHC100-</b>			-	1.083 €	1.290 €	1.290 €	1.510 €	1.450 €
117↔118,5	<b>HARTHC120-</b>				1.177 €	1.400 €	1.400 €	1.630 €	1.570 €
137↔138,5	<b>HARTHC140-</b>				1.272 €	1.510 €	1.510 €	1.750 €	1.690 €
77↔78,5	<b>HARTHC80-</b>				929 €	1.120 €	1.120 €	1.320 €	1.260 €
87↔88,5	<b>HARTHC90-</b>				966 €	1.165 €	1.165 €	1.375 €	1.315 €
97↔98,5	<b>HARTHC100-</b>	-	-		1.003 €	1.210 €	1.210 €	1.430 €	1.370 €
117↔118,5	<b>HARTHC120-</b>				1.077 €	1.300 €	1.300 €	1.530 €	1.470 €
137↔138,5	<b>HARTHC140-</b>				1.152 €	1.390 €	1.390 €	1.630 €	1.570 €

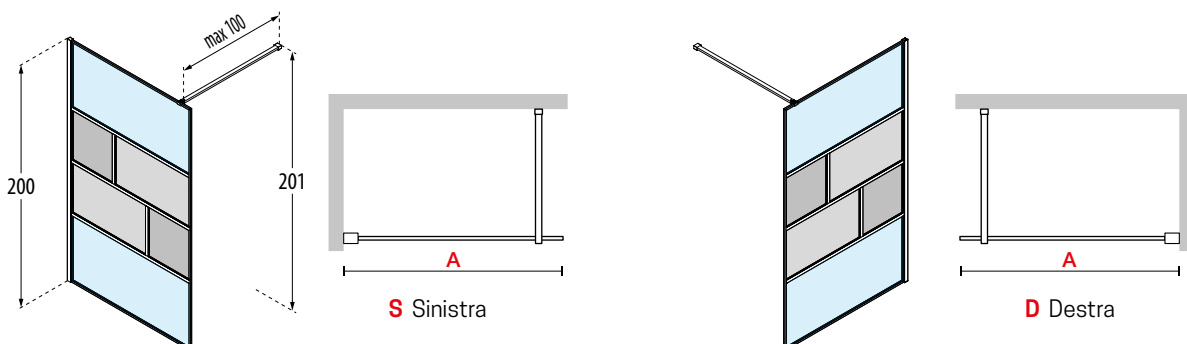
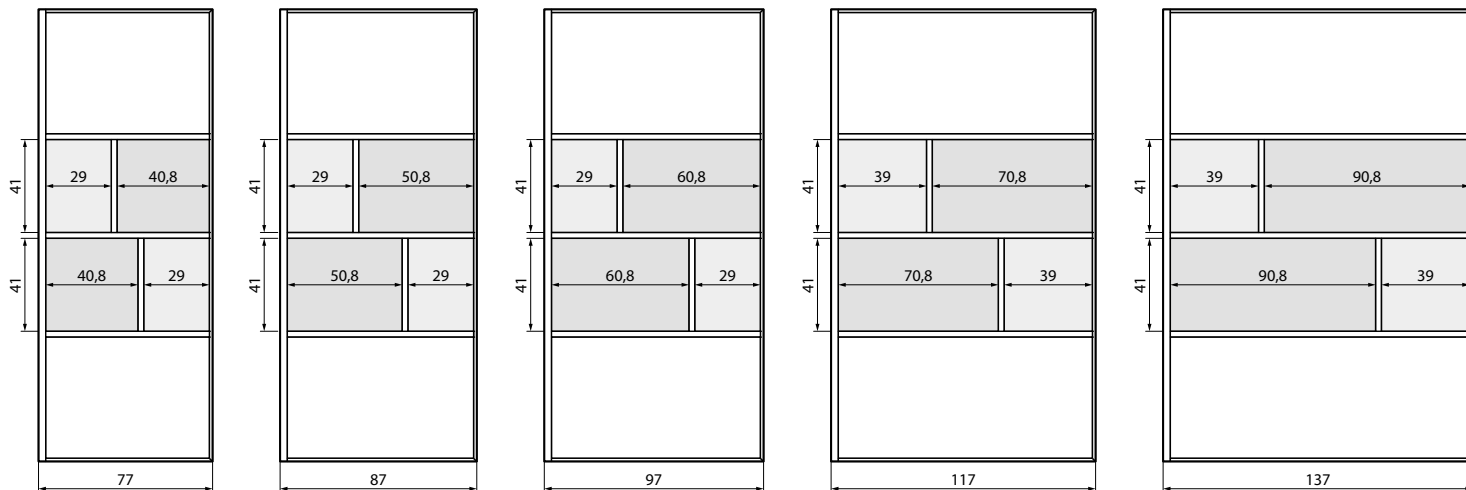



FLUTE / BRONZO SPAZZOLATO

**FINITURE VETRI**

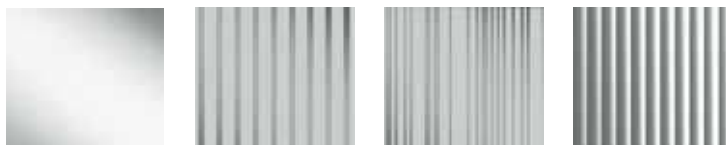

Traspirente  
cod 1

Linea 1  
cod 92

Linea 2  
cod 93

Flute  
cod 94

**FINITURE PROFILI**



Bianco opaco  
cod U

Cromo  
cod K

Nero opaco  
cod H

**FINITURE PROFILI "COLORATISSIMI"**

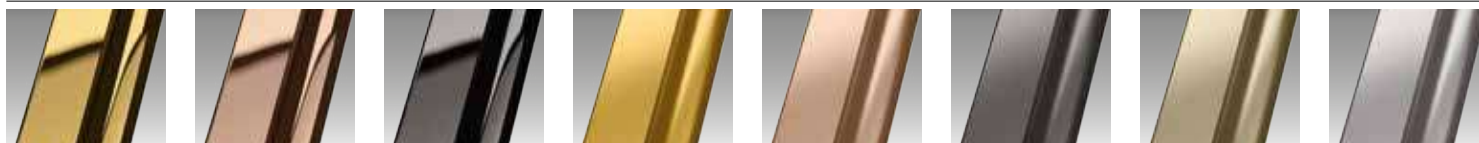

Oro lucido  
cod. O

Oro rosa lucido  
cod. M

Cromo nero lucido  
cod. L

Oro spazzolato  
cod. P

Oro rosa spazzolato  
cod. R

Cromo nero spazzolato  
cod. N

Bronzo spazzolato  
cod. Q

Inox spazzolato  
cod. Z



200 cm



6 mm



1,5 cm



## PARETE FISSA

Misure	Codice	Scelta vetro						Scelta profilo					
		1	44	54	92	93	94	U	K	H	O M L	P R Q N Z	
Misura effettiva d'ingombro													
<b>A</b>		Trasparente	Band Satin	Fumé	Linea 1	Linea 2	Flute	Bianco opaco	Cromo	Nero opaco	Oro lucido Oro rosa lucido Cromo nero lucido	Oro spazzolato Oro rosa spazzolato Bronzo spazzolato Cromo nero spazzolato Inox spazzolato	
77↔78,5	<b>HARTHP80-</b>							614 €	740 €	740 €	885 €	840 €	
87↔88,5	<b>HARTHP90-</b>				+ 180 €	+ 180 €	+ 100 €	635 €	765 €	765 €	915 €	870 €	
97↔98,5	<b>HARTHP100-</b>		+ 38 €	+ 100 €				655 €	790 €	790 €	945 €	900 €	
117↔118,5	<b>HARTHP120-</b>				+ 260 €	+ 260 €	+ 130 €	700 €	845 €	845 €	1.005 €	960 €	
137↔138,5	<b>HARTHP140-</b>							746 €	900 €	900 €	1.065 €	1.020 €	

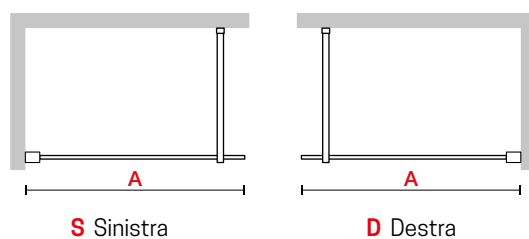
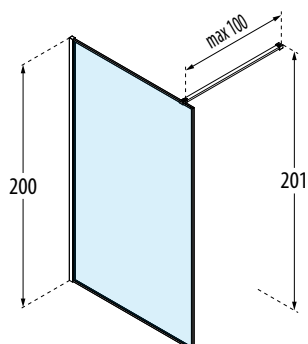





LINEA 2 / ORO ROSA LUCIDO

**FINITURE VETRI**



Trasparente  
cod. 1



Banda satin  
cod. 44



Fumé  
cod. 54



Linea 1  
cod. 92



Linea 2  
cod. 93



Flute  
cod. 94

**FINITURE PROFILI**



Bianco opaco  
cod. U



Cromo  
cod. K



Nero opaco  
cod. H

**FINITURE PROFILI "COLORATISSIMI"**



Oro lucido  
cod. O



Oro rosa lucido  
cod. M



Cromo nero lucido  
cod. L



Oro spazzolato  
cod. P



Oro rosa spazzolato  
cod. R



Cromo nero spazzolato  
cod. N

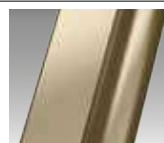

Bronzo spazzolato  
cod. Q



Inox spazzolato  
cod. Z

# GIADA H EDGE



◀ Ampia gamma di accessori da fissare al profilo



◀ Barra di sostegno opzionale



◀ Barra porta salviette opzionale

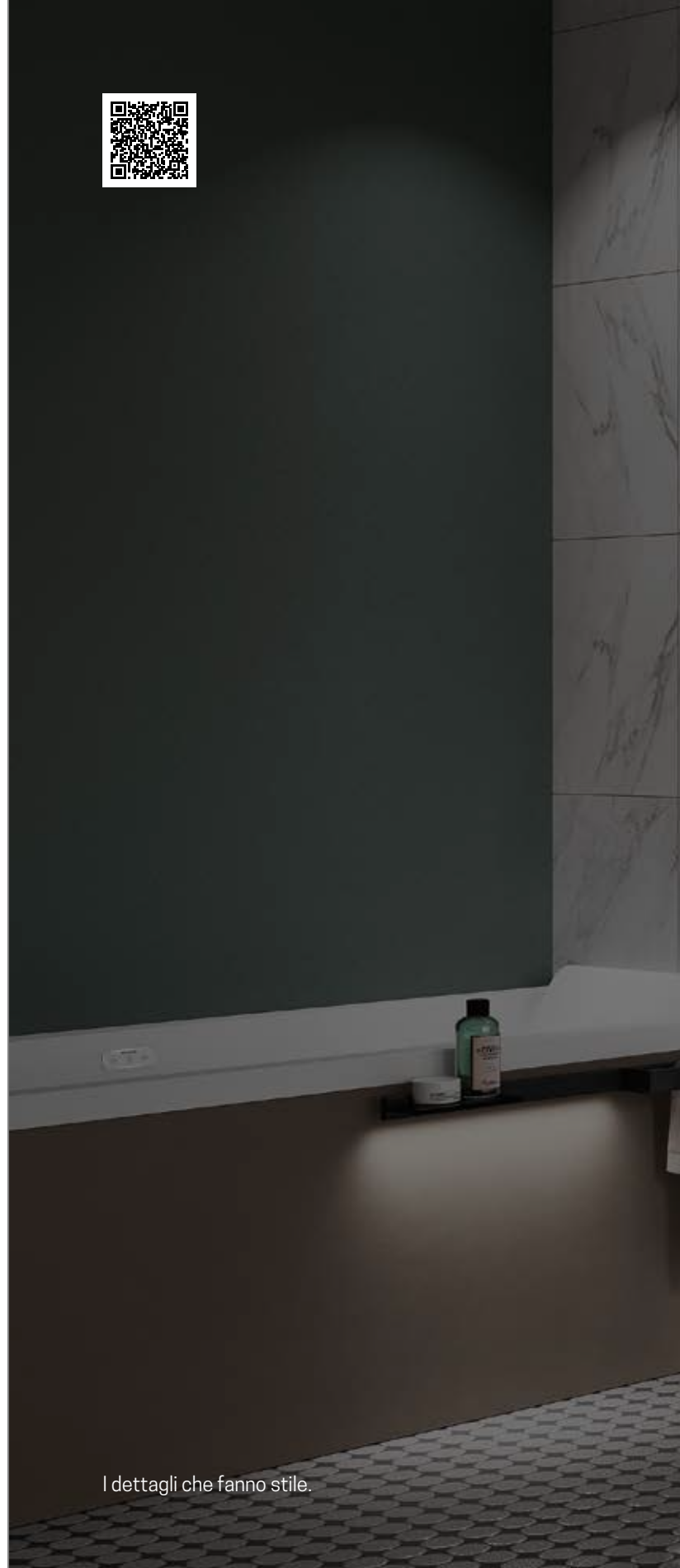

I dettagli che fanno stile.

## TRATTAMENTI





# GIADA H EDGE

# GIADA H

PARETE FISSA



195 cm



6 mm



1,5 cm



## FINITURE VETRI



Trasparente  
cod. 1



Banda satin  
cod. 44

## FINITURE PROFILI



Bianco  
cod. A



Silver  
cod. B



Cromo  
cod. K



Nero opaco  
cod. H

Misure	Codice	Scelta vetro		Scelta profilo			
		1	44	A	B	K	H
Misura effettiva d'ingombro		Trasparente	Band Satin	Bianco	Silver	Cromo	Nero opaco
<b>A</b>							
27↔28,5	<b>GIADAH30-</b>			307 €	338 €	375 €	375 €
37↔38,5	<b>GIADAH40-</b>			369 €	407 €	450 €	450 €
47↔48,5	<b>GIADAH50-</b>			425 €	469 €	519 €	519 €
57↔58,5	<b>GIADAH60-</b>			485 €	537 €	594 €	594 €
67↔68,5	<b>GIADAH70-</b>			498 €	549 €	607 €	607 €
72↔73,5	<b>GIADAH75-</b>			510 €	562 €	619 €	619 €
77↔78,5	<b>GIADAH80-</b>			524 €	574 €	632 €	632 €
87↔88,5	<b>GIADAH90-</b>		●	537 €	588 €	645 €	645 €
97↔98,5	<b>GIADAH100-</b>		●	555 €	613 €	677 €	677 €
107↔108,5	<b>GIADAH110-</b>		+ 38 €	568 €	625 €	689 €	689 €
117↔118,5	<b>GIADAH120-</b>		●	582 €	638 €	702 €	702 €
127↔128,5	<b>GIADAH130-</b>			594 €	652 €	715 €	715 €
137↔138,5	<b>GIADAH140-</b>		●	613 €	677 €	747 €	747 €
147↔148,5	<b>GIADAH150-</b>			632 €	695 €	765 €	765 €
157↔158,5	<b>GIADAH160-</b>			652 €	715 €	785 €	785 €
167↔168,5	<b>GIADAH170-</b>			682 €	750 €	825 €	825 €
177↔178,5	<b>GIADAH180-</b>			713 €	784 €	863 €	863 €

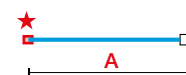
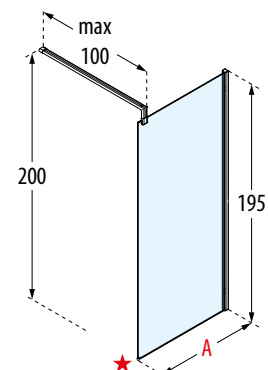

Piedini di fissaggio al pavimento

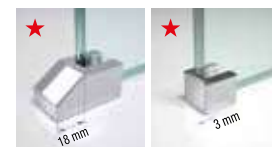

**DI SERIE, BARRA DI SOSTEGNO DA 100 CM**  
**BARRA DI SOSTEGNO EDGE E ALTRI OPTIONAL (VEDI PAG. 312)**



OPTIONAL

# GIADA HFP1

ANTINA GIREVOLE PER PARETE FISSA



195 cm



6 mm



## FINITURE VETRI



Trasparente  
cod. 1



Banda satin  
cod. 44

## FINITURE PROFILI



Bianco  
cod. A



Silver  
cod. B



Cromo  
cod. K



Nero opaco  
cod. H

Misure	Codice	Scelta vetro		Scelta profilo			
		1	44	A	B	K	H
Misura effettiva d'ingombro		Trasparente	Band Satin	Bianco	Silver	Cromo	Nero opaco
<b>A</b>	<b>GIADAHAP37-</b>		+ 38 €	266 €	292 €	320 €	320 €
40							

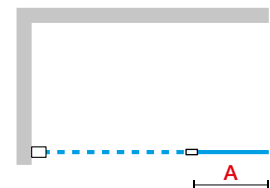
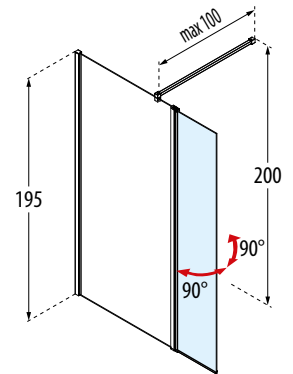

UTILIZZABILE ANCHE PER PARETE FISSA LUNES H (PAG. 318)

Costruzione del codice **Codice** + **Vetro** + **Profilo** = Codice prodotto finale = Codice prodotto finale

# GIADA HA

ANTINA GIREVOLE PER PARETE FISSA



## FINITURE VETRI

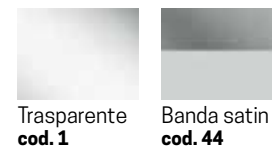

## FINITURE PROFILI



Misure	Installazione	Codice	Scelta vetro		Scelta profilo		
			1	44	A	K	H
Misura effettiva d'ingombro			Trasparente	Band Satin	Bianco	Cromo	Nero opaco
<b>A</b>			●	-	200 €	200 €	200 €
37	Destra	<b>GIADHA37-</b>			200 €	200 €	200 €
	Sinistra	<b>GIADHA37S-</b>		+ 38 €	200 €	200 €	200 €

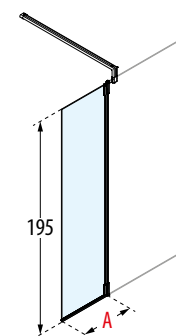

OPTIONAL

# GIADA HF KIT EDGE

FISSO IN LINEA PER PARETE FISSA



195 cm



6 mm



## FINITURE VETRI



Trasparente  
cod. 1

## FINITURE PROFILI



Bianco  
cod. A



Silver  
cod. B



Cromo  
cod. K



Nero opaco  
cod. H

Misure	Codice	Scelta vetro	Scelta profilo			
Misura effettiva d'ingombro		<b>1</b>	<b>A</b>	<b>B</b>	<b>K</b>	<b>H</b>
<b>A</b>		Trasparente	Bianco	Silver	Cromo	Nero opaco
37	<b>GIADAHF37-</b>		438 €	482 €	530 €	530 €

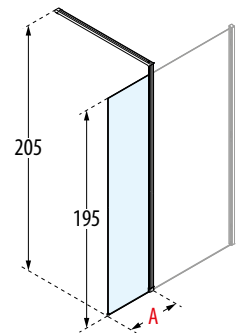

EDGE COLLECTION

# GIADA H+H KIT EDGE

PER COMPORRE UN GIADA H+H SELEZIONARE 3 CODICI: GIADA H + GIADA H + BARRA DI FISSAGGIO EDGE



## FINITURE PROFILI



Bianco  
cod. A

Silver  
cod. B



Cromo  
cod. K

Nero opaco  
cod. H

## BARRA DI FISSAGGIO EDGE PER GIADA H+H

Misure	Codice	Scelta finitura / prezzo			
		A	B	K	H
		Bianco	Silver	Cromo	Nero opaco
180	<b>R80EDGHH180-</b>	225 €	250 €	275 €	275 €

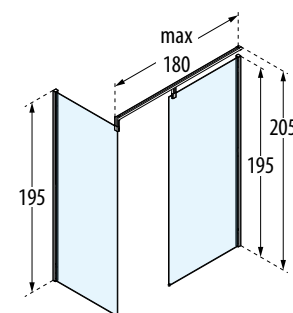



# GIADA HL

FISSO LATERALE PER KUADRA H



195 cm

6 mm



## FINITURE VETRI



Trasparente  
cod. 1



Band Satin  
cod. 44

## FINITURE PROFILI



Bianco  
cod. A



Silver  
cod. B



Cromo  
cod. K

Misure	Codice	Scelta vetro		Scelta profilo		
		1	44	A	B	K
Misura effettiva d'ingombro		Trasparente	Band Satin	Bianco	Silver	Cromo
<b>F/D</b>						
15	<b>GIADAHL15-</b>			154 €	173 €	192 €
30	<b>GIADAHL30-</b>		-	173 €	192 €	212 €
40	<b>GIADAHL40-</b>			199 €	218 €	237 €
68	<b>GIADAHL70-</b>			397 €	440 €	498 €
78	<b>GIADAHL80-</b>			422 €	467 €	524 €
88	<b>GIADAHL90-</b>		+ 38 €	447 €	492 €	549 €
98	<b>GIADAHL100-</b>			473 €	518 €	574 €
118	<b>GIADAHL120-</b>			498 €	543 €	600 €

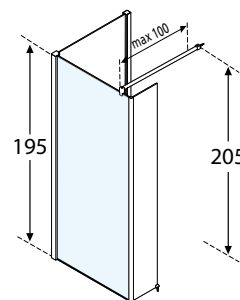
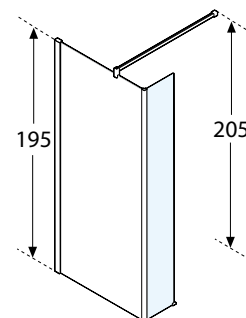

## OPTIONAL



**PIEDINO DI FISSAGGIO INTERNO AL PIATTO DOCCIA Ø 29 MM**

Codice	Prezzo
<b>R05KUHL1-K</b>	60 €

**DI SERIE, BARRA DI SOSTEGNO DA 100 CM**  
**LA BARRA DI SOSTEGNO DA 150 CM È OPTIONAL (VEDI PAG. 316)**

Piedini di fissaggio al pavimento

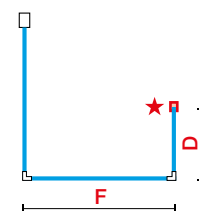

Costruzione del codice **Codice** + **Vetro** + **Profilo** = Codice prodotto finale

# BARRE DI SOSTEGNO **EDGE**



## BARRA DI SOSTEGNO EDGE PER GIADA H

Misure	Codice	Scelta finitura / prezzo			
		A	B	K	H
		Bianco	Silver	Cromo	Nero opaco
100	<b>R80EDGH100-</b>	182 €	200 €	219 €	219 €

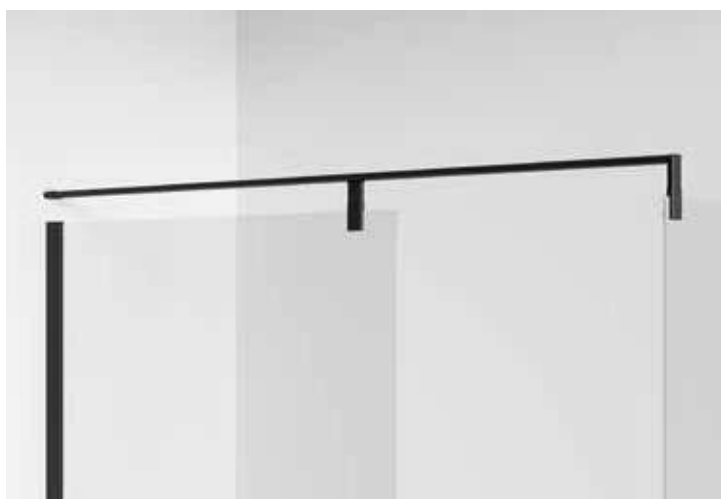

## SISTEMA DI FISSAGGIO EDGE (accorciabile) abbinabile a GIADA H+H

Misure	Codice	Scelta finitura / prezzo			
		A	B	K	H
		Bianco	Silver	Cromo	Nero opaco
180	<b>R80EDGHH180-</b>	225 €	250 €	275 €	275 €



## BARRA FINO A TERRA EDGE (accorciabile)

Codice	Scelta finitura / prezzo			
	A	B	K	H
	Bianco	Silver	Cromo	Nero opaco
<b>R80EDGHPAV-</b>	200 €	219 €	244 €	244 €

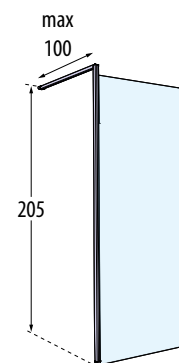

## KIT PER FISSAGGIO A SOFFITTO

Finitura	Codice	Prezzo
Bianco	<b>R801SOFEL-A</b>	40 €
Cromo	<b>R801SOFEL-K</b>	43 €
Nero opaco	<b>R801SOFEL-H</b>	43 €

# PORTA SALVIETTE **EDGE**



◀ **PORTA SALVIETTE EDGE** (fissaggio vetro/profilo)  
abbinabile a **GIADA HF**

Misure	Codice	Scelta finitura / prezzo			
		A	B	K	H
		Bianco	Silver	Cromo	Nero opaco
37	<b>R90AGEBPS37VP-</b>	157 €	175 €	194 €	194 €



◀ **BARRA ESTERNA EDGE PER GIADA H** (accorciabile)  
Fissaggio muro - profilo

Misure	Codice	Destra	Sinistra	Scelta finitura / prezzo			
		D-	S-	A	B	K	H
				Bianco	Silver	Cromo	Nero opaco
90	<b>R90AGEBPS90PM</b>	D-	S-	163 €	182 €	200 €	200 €
135	<b>R90AGEBPS135PM</b>	D-	S-	225 €	238 €	250 €	250 €
180	<b>R90AGEBPS180PM</b>	D-	S-	282 €	307 €	332 €	332 €

VERSIONE SINISTRA



◀ **BARRA ESTERNA EDGE PER GIADA H** (accorciabile)  
Fissaggio muro - vetro

Misure	Codice	Destra	Sinistra	Scelta finitura / prezzo			
		D-	S-	A	B	K	H
				Bianco	Silver	Cromo	Nero opaco
90	<b>R90AGEBPS90VM</b>	D-	S-	163 €	182 €	200 €	200 €
135	<b>R90AGEBPS135VM</b>	D-	S-	225 €	238 €	250 €	250 €
180	<b>R90AGEBPS180VM</b>	D-	S-	282 €	307 €	332 €	332 €

VERSIONE SINISTRA

# COMBINAZIONI

## GIADA H+HFA VERSIONE IN NICCHIA

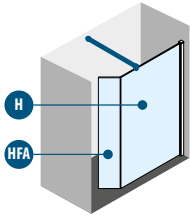

GIADA H  
GIADA HFA  
BARRA DI SOSTEGNO  
(in dotazione)

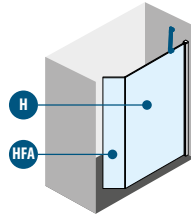

GIADA H  
GIADA HFA  
BARRA ORIENTABILE

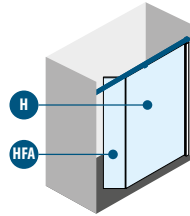

GIADA H  
GIADA HFA  
BARRA EVO (in nicchia)

## GIADA H+HFA VERSIONE AD ANGOLO

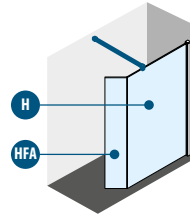

GIADA H  
GIADA HFA  
BARRA DI SOSTEGNO  
(in dotazione)

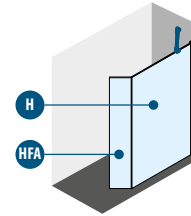

GIADA H  
GIADA HFA  
BARRA ORIENTABILE

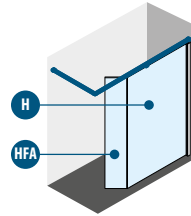

GIADA H  
GIADA HFA  
BARRA EVO (ad angolo)

## GIADA H+HFP1 VERSIONE IN NICCHIA

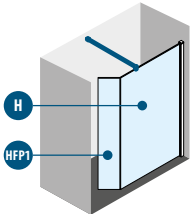

GIADA H  
GIADA HFP1  
BARRA DI SOSTEGNO  
(in dotazione)

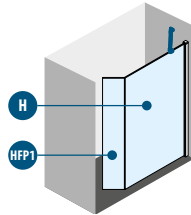

GIADA H  
GIADA HFP1  
BARRA ORIENTABILE

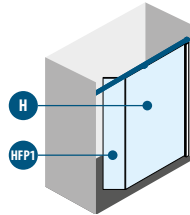

GIADA H  
GIADA HFP1  
BARRA EVO (in nicchia)

## GIADA H+HFP1 VERSIONE AD ANGOLO

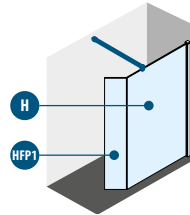

GIADA H  
GIADA HFP1  
BARRA DI SOSTEGNO  
(in dotazione)

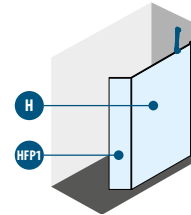

GIADA H  
GIADA HFP1  
BARRA ORIENTABILE

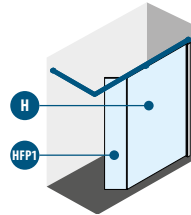

GIADA H  
GIADA HFP1  
BARRA EVO (ad angolo)

## GIADA H+H VERSIONE AD ANGOLO

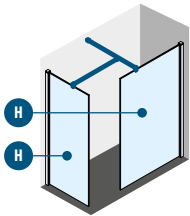

GIADA H x2  
BARRA DI SOSTEGNO  
(in dotazione)

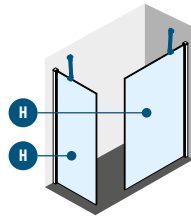

GIADA H x2  
BARRA ORIENTABILE

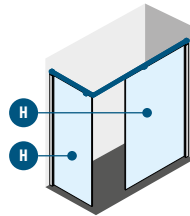

GIADA H x2  
BARRA EVO (ad angolo)

## GIADA H6 VERSIONE IN NICCHIA

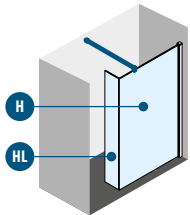

GIADA H  
GIADA HL  
BARRA DI SOSTEGNO  
(in dotazione)

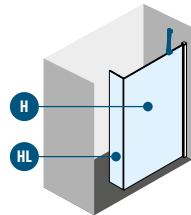

GIADA H  
GIADA HL  
BARRA ORIENTABILE

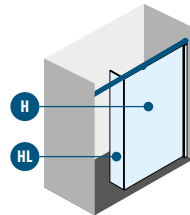

GIADA H  
GIADA HL  
BARRA EVO (in nicchia)

## GIADA H6 VERSIONE AD ANGOLO

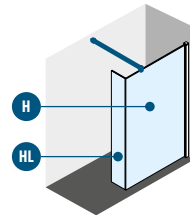

GIADA H  
GIADA HL  
BARRA DI SOSTEGNO  
(in dotazione)

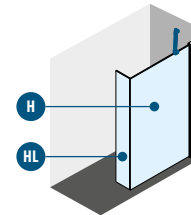

GIADA H  
GIADA HL  
BARRA ORIENTABILE

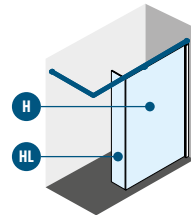

GIADA H  
GIADA HL  
BARRA EVO (ad angolo)

## GIADA H7 VERSIONE AD ANGOLO

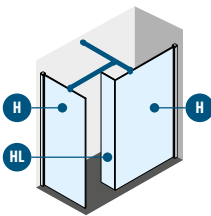

GIADA H x2  
GIADA HL  
BARRA DI SOSTEGNO  
(in dotazione)

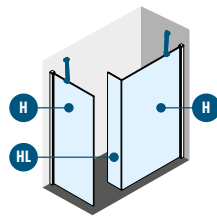

GIADA H x2  
GIADA HL  
BARRA ORIENTABILE  
x 2

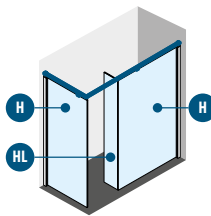

GIADA H x2  
GIADA HL  
BARRA EVO (ad angolo)

## KUADRA H9 VERSIONE CENTRO PARETE

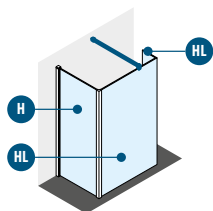

GIADA HL x2  
GIADA H  
BARRA DI SOSTEGNO (in dotazione)

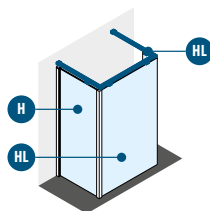

GIADA HL x2  
GIADA H  
BARRA EVO (a U)

## GIADA H9 VERSIONE AD ANGOLO

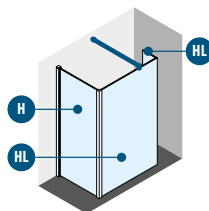

GIADA HL x2  
GIADA H  
BARRA DI SOSTEGNO (in dotazione)

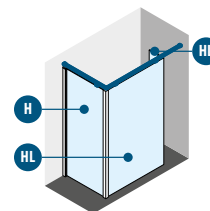

GIADA HL x2  
GIADA H  
BARRA EVO (ad angolo)

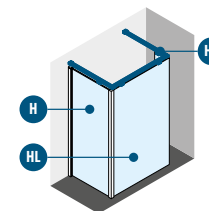

GIADA HL x2  
GIADA H  
BARRA EVO (a U)

## DATI TECNICI

### FINITURE PROFILI



Bianco/Cromo  
cod. A/D

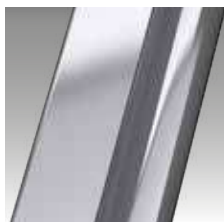

Silver  
cod. B



Cromo  
cod. K



Nero opaco  
cod. H

### VETRO TEMPRATO 6 mm (European Standards EN 14428)



Trasparente  
cod. 1



### SERIGRAFIA



Band satin  
cod. 44

### BARRA DI SOSTEGNO STANDARD (IN DOTAZIONE)



BARRA DI SOSTEGNO  
(2x2 cm) DA 100 cm

### MISURE DI INGOMBRO PROFILI DI FISSAGGIO

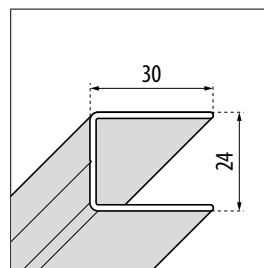

#### A MURO

Finitura	Codice
Bianco	<b>P01LGHST-A</b>
Silver	<b>P01LGHST-B</b>
Cromo	<b>P01LGHST-K</b>

PER TUTTE LE ALTRE BARRE DI SOSTEGNO - VEDI PAG. 316

## BARRE DI SOSTEGNO PER KUADRA H E GIADA H

### BARRA DI SOSTEGNO (2X2 CM) 150 CM (barra da 100 cm in dotazione)



Finitura	Codice	Prezzo
Bianco	<b>R80GIANF15-A</b>	93 €
Bianco opaco	<b>R80GIANF15-U</b>	93 €
Silver	<b>R80GIANF15-B</b>	104 €
Cromo	<b>R80GIANF15-K</b>	115 €
Nero opaco	<b>R80GIANF15-H</b>	115 €
Inox sp.	<b>R80GIANF15-Z</b>	138 €

### KIT 2 BARRE A "T"



Finitura	Codice	Prezzo
Bianco	<b>R80KUORT150-D</b>	160 €
Silver	<b>R80KUORT150-B</b>	172 €
Cromo	<b>R80KUORT150-K</b>	183 €
Nero opaco	<b>R80KUORT150-H</b>	183 €

- 2 barre da 150 cm (accorciabili)
- 1 attacco a muro
- 2 morsetti di fissaggio al vetro

### BARRA DI SOSTEGNO ORIENTABILE



Finitura	Misure	Codice	Prezzo
Bianco op.	25 cm	<b>R80LOU250-U</b>	72 €
Cromo	25 cm	<b>R80LOU250-K</b>	72 €
Nero op.	25 cm	<b>R80LOU250-H</b>	72 €
Inox	25 cm	<b>R80LOU250-Z</b>	87 €
Bianco op.	35 cm	<b>R80LOU350-U</b>	78 €
Cromo	35 cm	<b>R80LOU350-K</b>	78 €
Nero op.	35 cm	<b>R80LOU350-H</b>	78 €
Inox sp.	35 cm	<b>R80LOU350-Z</b>	94 €
Bianco op.	45 cm	<b>R80LOU450-U</b>	85 €
Cromo	45 cm	<b>R80LOU450-K</b>	85 €
Nero op.	45 cm	<b>R80LOU450-H</b>	85 €
Inox sp.	45 cm	<b>R80LOU450-Z</b>	102 €

### SISTEMA DI FISSAGGIO EVO (IN NICCHIA)



Finitura	Codice	Prezzo
Bianco opaco	<b>KUADHSFN-U</b>	170 €
Silver	<b>KUADHSFN-B</b>	183 €
Cromo	<b>KUADHSFN-K</b>	204 €
Nero opaco	<b>KUADHSFN-H</b>	204 €
Inox sp.	<b>KUADHSFN-Z</b>	245 €

- 1 barra frontale da 180 cm
- 1 morsetto di fissaggio

### SISTEMA DI FISSAGGIO EVO (ANGOLO)



Finitura	Codice	Prezzo
Bianco opaco	<b>KUADHSF-U</b>	229 €
Silver	<b>KUADHSF-B</b>	247 €
Cromo	<b>KUADHSF-K</b>	267 €
Nero opaco	<b>KUADHSF-H</b>	267 €
Inox sp.	<b>KUADHSF-Z</b>	321 €

- 1 barra frontale da 180 cm
- 1 barra laterale da 120 cm
- 2 morsetti di fissaggio
- 1 angolare di unione

### SISTEMA DI FISSAGGIO EVO (A "C")



Finitura	Codice	Prezzo
Bianco opaco	<b>KUADHSFC-U</b>	297 €
Silver	<b>KUADHSFC-B</b>	310 €
Cromo	<b>KUADHSFC-K</b>	329 €
Nero opaco	<b>KUADHSFC-H</b>	329 €
Inox sp.	<b>KUADHSFC-Z</b>	395 €

- 1 barra frontale da 180 cm
- 2 barre laterali da 120 cm
- 4 morsetti di fissaggio
- 2 angolari di unione

## BARRE DI SOSTEGNO PER KUADRA H E GIADA H

### PROFILO DI TENUTA IN ALLUMINIO PER PARETI DA 6/8 MM



Finitura	Misure	Codice	Prezzo
Bianco	100	<b>P51BOHU10-A</b>	28 €
Bianco opaco		<b>P51BOHU10-U</b>	28 €
Silver		<b>P51BOHU10-B</b>	33 €
Cromo		<b>P51BOHU10-K</b>	37 €
Nero opaco		<b>P51BOHU10-H</b>	37 €
Inox sp.		<b>P51BOHU10-Z</b>	45 €
Bianco	150	<b>P51BOHU15-A</b>	34 €
Bianco opaco		<b>P51BOHU15-U</b>	34 €
Silver		<b>P51BOHU15-B</b>	39 €
Cromo		<b>P51BOHU15-K</b>	45 €
Nero opaco		<b>P51BOHU15-H</b>	45 €
Inox sp.		<b>P51BOHU15-Z</b>	54 €

### SUPPORTI PER LA BARRA DI SOSTEGNO A SOFFITTO



Finitura	Codice	Prezzo
Bianco	<b>R801SOFEL-A</b>	40 €
Cromo	<b>R801SOFEL-K</b>	43 €
Nero opaco	<b>R801SOFEL-H</b>	43 €

Il kit comprende solo i 2 attacchi, da utilizzare con la barra da 100 già fornita

### BARRA DI SOSTEGNO ORIENTABILE



Finitura	Misure	Codice	Prezzo
Bianco opaco	100	<b>R80KUOR100-U</b>	105 €
Silver		<b>R80KUOR100-B</b>	117 €
Cromo		<b>R80KUOR100-K</b>	127 €
Nero opaco	100	<b>R80KUOR100-H</b>	127 €
Inox sp.		<b>R80KUOR100-Z</b>	153 €
Bianco opaco		150	<b>R80KUOR150-U</b>
Silver	<b>R80KUOR150-B</b>		120 €
Cromo	<b>R80KUOR150-K</b>		132 €
Nero opaco	150	<b>R80KUOR150-H</b>	132 €
Inox sp.		<b>R80KUOR150-Z</b>	159 €
Bianco opaco		180	<b>R80KUOR180-U</b>
Silver	<b>R80KUOR180-B</b>		124 €
Cromo	<b>R80KUOR180-K</b>		135 €
Nero opaco	180	<b>R80KUOR180-H</b>	135 €
Inox sp.		<b>R80KUOR180-Z</b>	162 €

1 barra orientabile da 100/150/180 cm (accorciabile), 1 attacco a muro, 1 morsetto di fissaggio al vetro

### PIEDINO DI FISSAGGIO INTERNO AL PIATTO DOCCIA Ø 29 MM



Codice	Prezzo
<b>R05KUH1-K</b>	60 €

Per fissi Kuadra HL e Giada HL

### PROFILO DI FISSAGGIO A SOFFITTO



Finitura	Codice	Prezzo
Bianco	<b>R80GKHSOF-D</b>	190 €
Bianco opaco	<b>R80GKHSOF-U</b>	190 €
Silver	<b>R80GKHSOF-B</b>	209 €
Cromo	<b>R80GKHSOF-K</b>	230 €
Nero opaco	<b>R80GKHSOF-H</b>	230 €
Inox sp.	<b>R80GKHSOF-Z</b>	276 €

altezza totale 2979 mm

# LUNES H

PARETE FISSA



195 cm



6 mm



1,5 cm



## FINITURE VETRI



Trasparente  
cod. 1



Aqua  
cod. 2



Ser. Quadra  
cod. 14

## FINITURE PROFILI



Bianco  
cod. A



Silver  
cod. B



Cromo  
cod. K



Argento  
cod. J

Misure	Codice	Scelta vetro			Scelta profilo			
		1	2	14	A	B	K	J
Misura effettiva d'ingombro		Trasparente	Aqua	Serigrafia Quadra	Bianco	Silver	Cromo	Argento
<b>A</b>		●						
57↔58,5	<b>LUNESH60-</b>	●			443 €	489 €	542 €	489 €
67↔68,5	<b>LUNESH70-</b>	●			450 €	495 €	548 €	495 €
72↔73,5	<b>LUNESH75-</b>				457 €	502 €	554 €	502 €
77↔78,5	<b>LUNESH80-</b>	●			464 €	508 €	560 €	508 €
87↔88,5	<b>LUNESH90-</b>	●			470 €	515 €	567 €	515 €
97↔98,5	<b>LUNESH100-</b>	●	+ 38 €	+ 38 €	477 €	522 €	573 €	522 €
107↔108,5	<b>LUNESH110-</b>	●			483 €	529 €	580 €	529 €
117↔118,5	<b>LUNESH120-</b>	●			489 €	535 €	587 €	535 €
127↔128,5	<b>LUNESH130-</b>	●			495 €	542 €	594 €	542 €
137↔138,5	<b>LUNESH140-</b>	●			502 €	548 €	600 €	548 €
H 80↔200 L 30↔150	SPECIAL <b>LUNESHSP</b>		+ 38 €	-	632 €	692 €	757 €	692 €

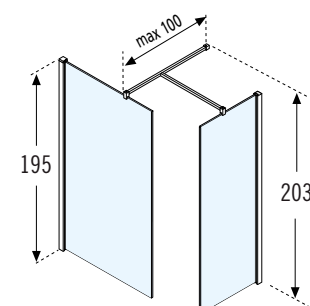
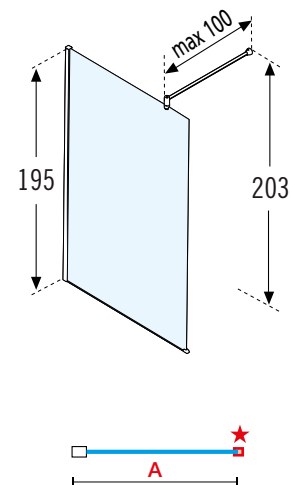

per comporre un **LUNES H+H**  
selezionare 3 codici:  
**LUNES H + LUNES H + R80LUH-K**

Piedini di fissaggio al pavimento



**POSSIBILITÀ DI ABBINARE ANTINA GIREVOLE HFP1 PAG. 307**

**DI SERIE BARRA DI SOSTEGNO DA 100 CM  
LA BARRA DI SOSTEGNO DA 150 CM È OPTIONAL (VEDI PAG. 316)**





## DATI TECNICI

### FINITURE PROFILI



Bianco  
cod. A



Silver  
cod. B



Cromo  
cod. K



Argento  
cod. J

### VETRO TEMPRATO 6 mm (European Standards EN 14428)



Trasparente  
cod. 1



Aqua  
cod. 2

### SERIGRAFIA



Quadra  
cod. 14

### BARRA DI SOSTEGNO STANDARD (IN DOTAZIONE)



BARRA DI SOSTEGNO  
DA 100 cm

### MISURE DI INGOMBRO PROFILI DI FISSAGGIO

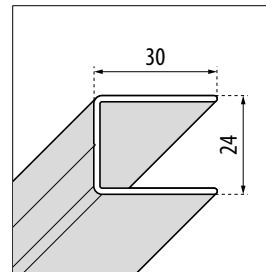

#### A MURO

Finitura	Codice
Bianco	<b>P01LGHST-A</b>
Silver	<b>P01LGHST-B</b>
Cromo	<b>P01LGHST-K</b>

### OPTIONAL



#### BARRA DI SOSTEGNO FISSA 150 CM

(barra da 100 cm in dotazione)

Finitura	Codice	Prezzo
Bianco	<b>R80LUH15-A</b>	60 €
Silver	<b>R80LUH15-B</b>	65 €
Cromo	<b>R80LUH15-K</b>	72 €



#### PROFILO DI TENUTA IN ALLUMINIO PER FISSI DA 6/8 MM

Finitura	Misure	Codice	Prezzo
Bianco	100	<b>P51BOHU10-A</b>	28 €
Silver		<b>P51BOHU10-B</b>	33 €
Cromo		<b>P51BOHU10-K</b>	37 €
Bianco	150	<b>P51BOHU15-A</b>	34 €
Silver		<b>P51BOHU15-B</b>	39 €
Cromo		<b>P51BOHU15-K</b>	45 €



#### GIUNZIONE BARRA DI SOSTEGNO PER VERSIONE H+H

Codice	Prezzo
<b>R80LUH-K</b>	37 €

- 
- 323 Novosolid
  - 327 Novomatt
  - 331 Custom Touch
  - 335 Custom
  - 339 Olympic Plus
  - 341 Olympic
  - 343 Victory

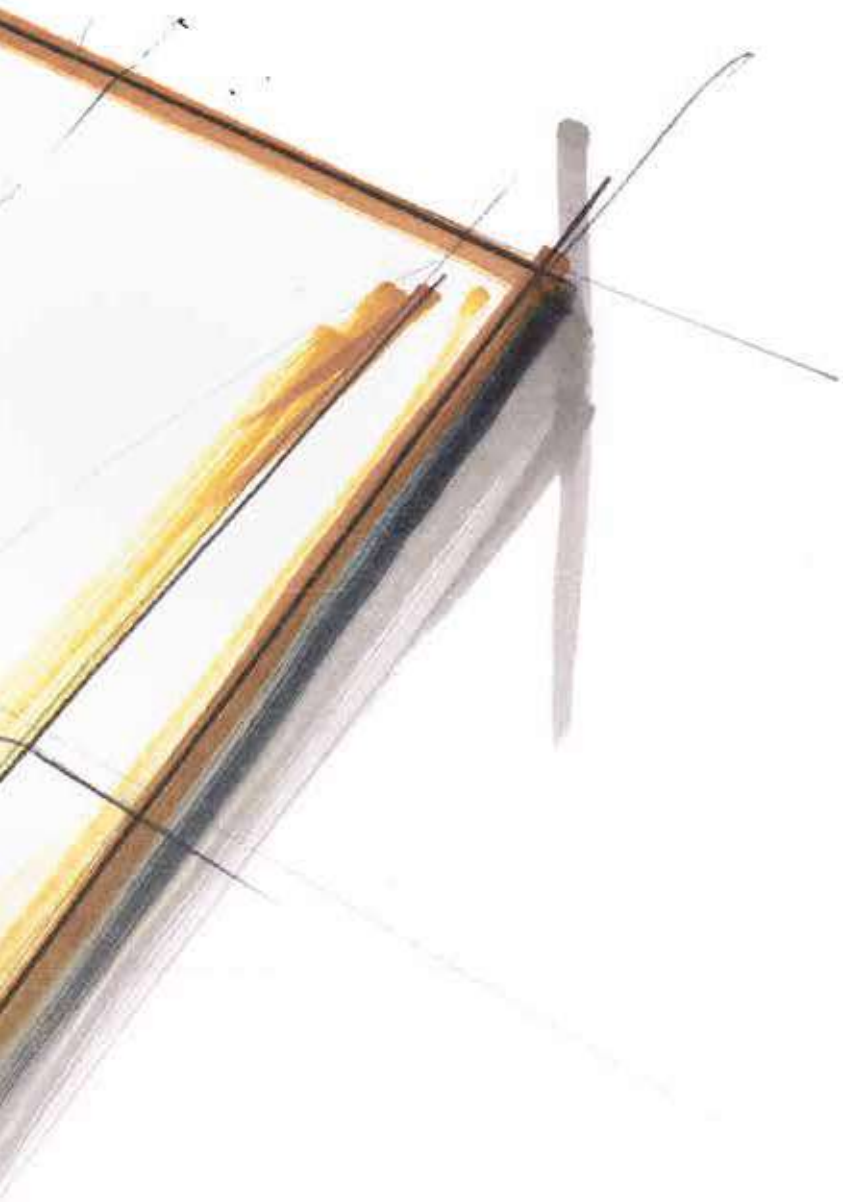

# PIATTI DOCCIA

## L'OPZIONE GIUSTA SERVITA SU UN PIATTO DOCCIA

Incredibilmente resistente agli urti e di facile collocazione, il piatto doccia Novellini diventa la base stabile di un benessere quotidiano. Sempre essenziale ed elegante, il design si fa ancor più moderno nelle serie ultra piatte. La facilità di pulizia rafforza la funzionalità degli elementi per la composizione di un bagno pratico e bello. Colori e dimensioni, misure e materiali permettono una personalizzazione senza precedenti.

# NOVOSOLID

## PIATTO DOCCIA IN RESINA.



◀ Piletta dello stesso materiale



◀ Stampaggio con nervatura per una maggiore garanzia di planarità



◀ Texture naturale effetto pietra in bianco, nero, corda e grigio ardesia

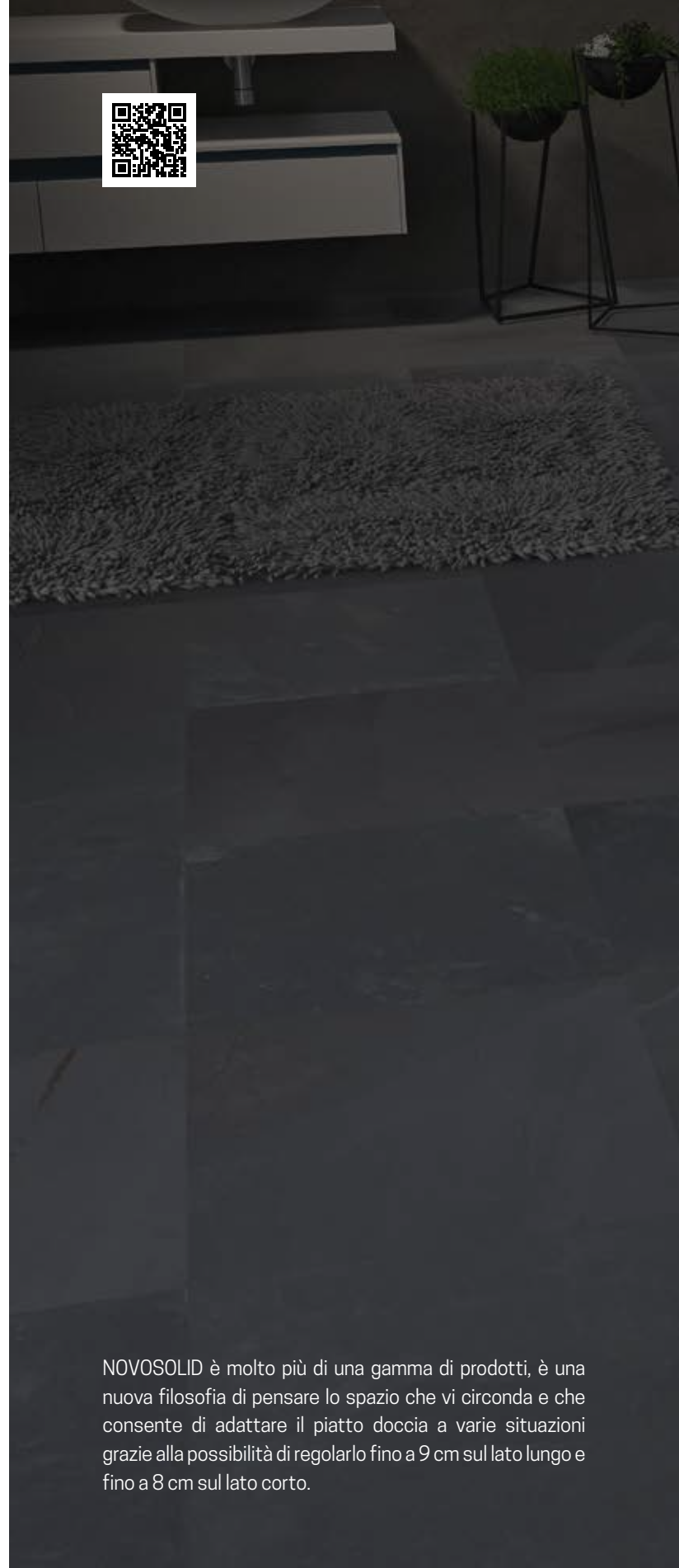

NOVOSOLID è molto più di una gamma di prodotti, è una nuova filosofia di pensare lo spazio che vi circonda e che consente di adattare il piatto doccia a varie situazioni grazie alla possibilità di regolarlo fino a 9 cm sul lato lungo e fino a 8 cm sul lato corto.



NOVOSOLID

# NOVOSOLID

# NOVOSOLID

Misure	Codice	Scelta finitura / Prezzo			
		30	27	29	28
<b>Ax B -2 / +3 mm</b>		Bianco	Corda	Grigio	Nero
80 x 80	<b>NOS804-</b>	541 €	593 €	593 €	623 €
90 x 90	<b>NOS904-</b>	591 €	650 €	650 €	683 €
100 x 100	<b>NOS1004-</b>	620 €	684 €	684 €	718 €
100 x 80	<b>NOS100804-</b>	591 €	650 €	650 €	683 €
120 x 70	<b>NOS120704-</b>	611 €	671 €	671 €	705 €
120 x 80	<b>NOS120804-</b>	656 €	721 €	721 €	757 €
120 x 90	<b>NOS120904-</b>	699 €	769 €	769 €	808 €
120 x 100	<b>NOS120104-</b>	741 €	816 €	816 €	857 €
140 x 70	<b>NOS140704-</b>	674 €	740 €	740 €	778 €
140 x 80	<b>NOS140804-</b>	712 €	782 €	782 €	821 €
140 x 90	<b>NOS140904-</b>	779 €	857 €	857 €	901 €
140 x 100	<b>NOS140104-</b>	805 €	886 €	886 €	931 €
150 x 70	<b>NOS150704-</b>	724 €	795 €	795 €	835 €
150 x 80	<b>NOS150804-</b>	755 €	830 €	830 €	872 €
160 x 70	<b>NOS160704-</b>	777 €	855 €	855 €	898 €
160 x 80	<b>NOS160804-</b>	800 €	879 €	879 €	924 €
160 x 90	<b>NOS160904-</b>	865 €	950 €	950 €	998 €
160 x 100	<b>NOS160104-</b>	920 €	1.010 €	1.010 €	1.061 €
170 x 70	<b>NOS170704-</b>	792 €	870 €	870 €	914 €
170 x 80	<b>NOS170804-</b>	887 €	974 €	974 €	1.024 €
180 x 80	<b>NOS180804-</b>	883 €	969 €	969 €	1.018 €
180 x 90	<b>NOS180904-</b>	954 €	1.048 €	1.048 €	1.101 €

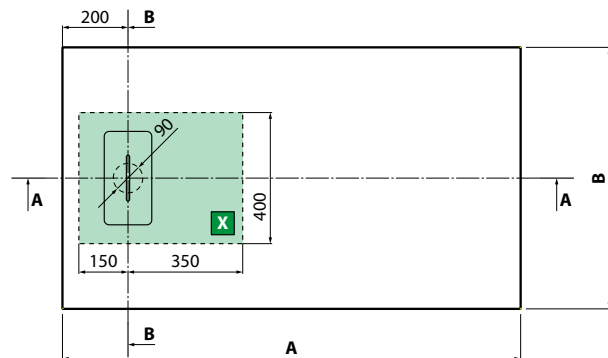

## INSTALLAZIONE APPOGGIO PAVIMENTO

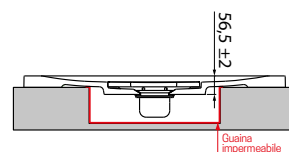
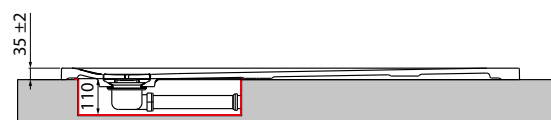

## INSTALLAZIONE RIALZATA CON PIEDINI D'APPOGGIO E PANNELLI ALZATA (ACCORCIABILI)

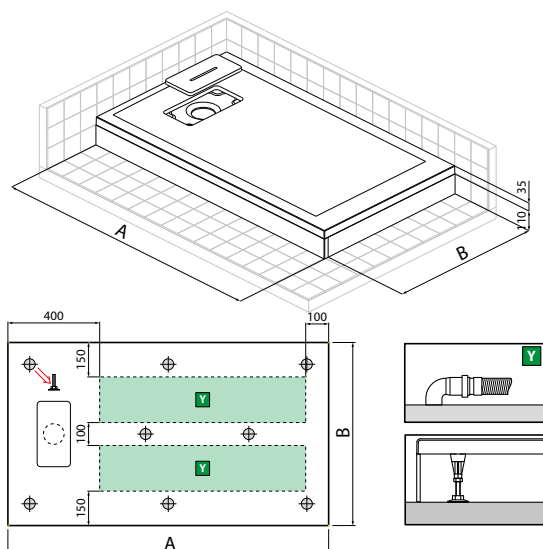

### OPTIONAL



Piletta di scarico Ø 90  
non fornita

Codice	Prezzo
<b>PIL90PCAB-CR40</b>	37 €

## INSTALLAZIONE A FILO PAVIMENTO

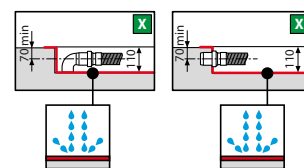
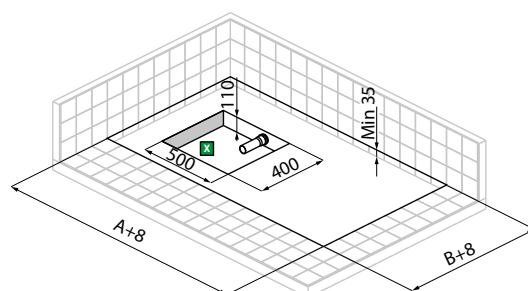

Per una ottimale tenuta si consiglia l'uso della nostra piletta di scarico **PIL90PCAB-CR40**, oppure di pilette di scarico dotate di guarnizione a doppio labbro

## INSTALLAZIONE A FILO PAVIMENTO



## INSTALLAZIONE APPOGGIO PAVIMENTO



## INSTALLAZIONE RIALZATA CON PIEDINI D'APPOGGIO E PANNELLI ALZATA (ACCORCIABILI)



### OPTIONAL

- Kit pannelli alzata (solo per installazione ad angolo)**
- 1 pannello lato corto da 100 cm più 1 pannello lato lungo
  - Altezza pannelli 11 cm

Finitura	Misura pannello lungo	Misura taglio min-max	Codice	Prezzo
Bianco opaco	100	70-100	<b>PANPFLNS03-30</b>	247 €
Corda	100	70-100	<b>PANPFLNS03-27</b>	249 €
Grigio	100	70-100	<b>PANPFLNS03-29</b>	249 €
Nero opaco	100	70-100	<b>PANPFLNS03-28</b>	252 €
Bianco opaco	150	100-150	<b>PANPFLNS02-30</b>	280 €
Corda	150	100-150	<b>PANPFLNS02-27</b>	283 €
Grigio	150	100-150	<b>PANPFLNS02-29</b>	283 €
Nero opaco	150	100-150	<b>PANPFLNS02-28</b>	285 €
Bianco opaco	180	150-180	<b>PANPFLNS01-30</b>	294 €
Corda	180	150-180	<b>PANPFLNS01-27</b>	298 €
Grigio	180	150-180	<b>PANPFLNS01-29</b>	298 €
Nero opaco	180	150-180	<b>PANPFLNS01-28</b>	300 €

## KIT DI RIPARAZIONE



### OPTIONAL

- KIT DI RIPARAZIONE composto da:**  
Resina bicomponente protettiva per il taglio a misura + kit di riparazione (in blister personalizzato)

Finitura	Codice	Prezzo
Bianco opaco	<b>KITRNS-30</b>	139 €
Corda	<b>KITRNS-27</b>	140 €
Grigio	<b>KITRNS-29</b>	140 €
Nero opaco	<b>KITRNS-28</b>	142 €

## TAGLIO

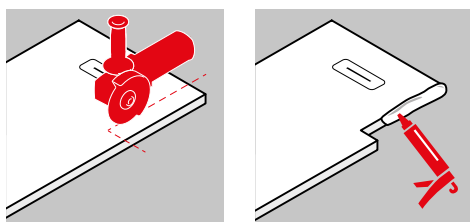

## RIPARAZIONE

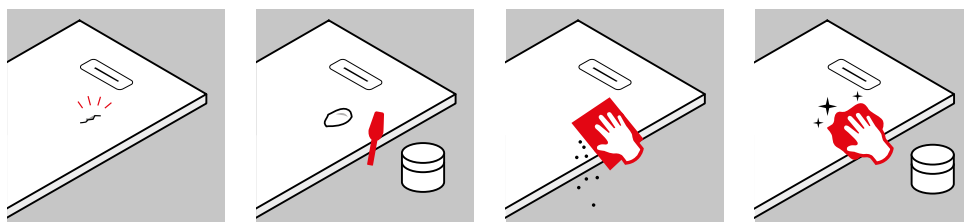

**Novellini conferma la garanzia sul prodotto anche dopo il taglio solo se la superficie è stata trattata con il kit di riparazione e finitura.**

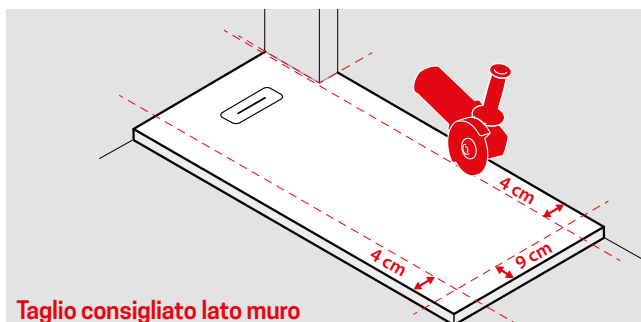

**Taglio consigliato lato muro**

## TAGLIO A MISURA

NOVOSOLID è molto più di un piatto doccia, è una nuova filosofia di pensare lo spazio che vi circonda e che consente di adattare il piatto doccia a varie situazioni grazie alla possibilità di regolarlo fino a 9 cm sul lato lungo e fino a 8 cm sul lato corto.

# NOVOMATT

## PIATTO DOCCIA IN MINERALSOLID EFFETTO PIETRA



### OPTIONAL

Piletta di scarico ø 90  
non fornita

Codice	Prezzo
PIL90PCAB-CR40	37 €



### IN DOTAZIONE

Copripiletta in acciaio inox  
inclusa nel prezzo

### OPTIONAL

Copripiletta di scarico  
in tinta col piatto doccia



Codice	Scelta finitura / Prezzo				
	V3	V4	V5	V6	V7
	Pietra bianco opaco	Pietra grigio	Pietra cappuccino	Pietra tortora	Pietra nero antracite
R90CPILDST-	35 €	35 €	35 €	35 €	35 €

## IL MATERIALE

NOVOMATT è un materiale composito tecnologicamente avanzato ed unico, formato da un'alta percentuale di cariche minerali naturali ed una bassa percentuale di polimeri poliesteri ed acrilici di elevata purezza; è quindi un materiale inerte, ipoallergenico e non tossico. È rivestito da uno smalto tecnico ad affetto estetico opaco. Questo rivestimento abbina ottime caratteristiche di resistenza a completa ripristinabilità della superficie.

Pietra  
bianco opaco  
(V3)

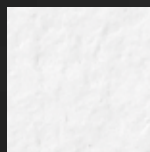

Pietra  
Grigio  
(V4)

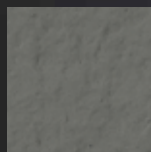

Pietra  
Cappuccino  
(V5)

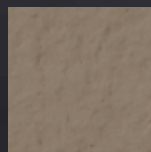

Pietra  
Tortora  
(V6)

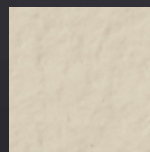

Pietra Nero  
antracite  
(V7)

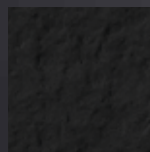



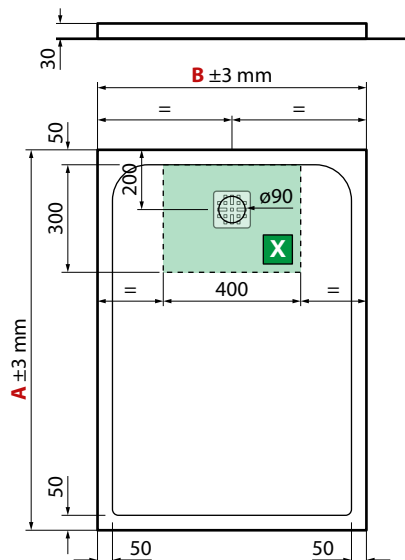

Solo per misure 180x80 e 180x90

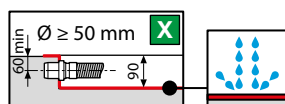
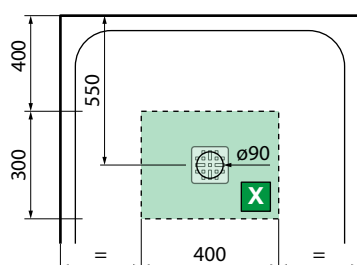

Misure		Codice	Scelta finitura / Prezzo				
			V3	V4	V5	V6	V7
			Pietra bianco opaco	Pietra grigio	Pietra cappuccino	Pietra tortora	Pietra nero antracite
80 x 80	800 x 800	<b>NVM803-</b>	488 €			536 €	
90 x 90	900 x 900	<b>NVM903-</b>	535 €			589 €	
100 x 100	1000 x 1000	<b>NVM1003-</b>	587 €			645 €	
90 x 70	900 x 700	<b>NVM90703-</b>	462 €			508 €	
100 x 70	1000 x 700	<b>NVM100703-</b>	475 €			522 €	
100 x 80	1000 x 800	<b>NVM100803-</b>	505 €			555 €	
100 x 90	1000 x 900	<b>NVM100903-</b>	546 €			600 €	
120 x 70	1200 x 700	<b>NVM120703-</b>	522 €			574 €	
120 x 80	1200 x 800	<b>NVM120803-</b>	570 €			627 €	
120 x 90	1200 x 900	<b>NVM120903-</b>	596 €			656 €	
120 x 100	1200 x 1000	<b>NVM120103-</b>	640 €			704 €	
140 x 70	1400 x 700	<b>NVM140703-</b>	603 €			664 €	
140 x 80	1400 x 800	<b>NVM140803-</b>	643 €			707 €	
140 x 90	1400 x 900	<b>NVM140903-</b>	706 €			777 €	
140 x 100	1400 x 1000	<b>NVM140103-</b>	756 €			831 €	
160 x 70	1600 x 700	<b>NVM160703-</b>	697 €			767 €	
160 x 80	1600 x 800	<b>NVM160803-</b>	720 €			792 €	
160 x 90	1600 x 900	<b>NVM160903-</b>	771 €			849 €	
160 x 100	1600 x 1000	<b>NVM160103-</b>	862 €			949 €	
180 x 80	1800 x 800	<b>NVM180803-</b>	797 €			876 €	
180 x 90	1800 x 900	<b>NVM180903-</b>	862 €			949 €	

Costruzione del codice **Codice + Finitura** = Codice prodotto finale

## SAGOMATURA SU MISURA

I piatti NOVOMATT possono essere tagliati dall'installatore fino a 2,5cm dal bordo, Novellini offre un servizio di taglio in lunghezza e/o larghezza comunicando le misure al momento dell'ordine. Forniamo anche i piatti doccia con scassi eseguiti su misura per sagomare il piatto doccia esattamente allo spazio disponibile. I tagli devono comunque essere rettilinei, non sono quindi consentiti tagli curvi o ad arco (**taglio fuori squadra fino a 2,5 cm\***). Non è poi possibile tagliare il piatto doccia attorno allo scarico per un'area pari a 40 x 40 cm.



Riduzione lato corto



Riduzione lato lungo

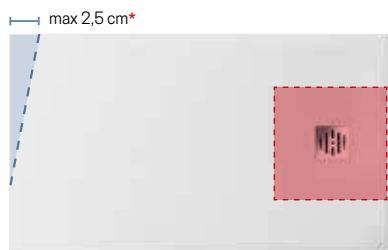

Riduzione lato corto  
taglio obliquo fuori squadra \*



Taglio speciale giro colonna

TAGLIO (consegna indicativa 4-5 settimane)  
 AREA NON TAGLIABILE

- 1 Taglio** € 55,00  
 riduzione in larghezza / in profondità  
**taglio fuori squadra fino a 2,5 cm**  
 senza ripristino della texture
- 2 Taglio** € 110,00  
 riduzione in larghezza / in profondità  
**taglio fuori squadra fino a 2,5 cm**  
 con ripristino della texture
- 3 Taglio** € 110,00  
 riduzione in larghezza / in profondità  
**taglio fuori squadra oltre 2,5 cm**  
 senza ripristino della texture
- 4 Taglio** € 165,00  
 riduzione in larghezza / in profondità  
**taglio fuori squadra oltre 2,5 cm**  
 con ripristino della texture
- 5 Taglio** € 220,00  
 speciale giro colonna  
**prezzo indicativo per singolo taglio grezzo** - eventuali  
 ricostruzioni da valutare e quotare di volta in volta.



# CUSTOM TOUCH e CUSTOM

è il piatto doccia:





# 1

## ESTETICO e FUNZIONALE

Lo spessore di soli 3,5 cm e i nuovi sistemi di scarico da 40 l/min, permettono installazioni in appoggio o a filo pavimento, per la massima resa estetica e di utilizzo.



Piletta ispezionabile ad alta evacuazione (in dotazione)

CUSTOM TOUCH

# 2

## ADATTABILE

Sagomabile per adattarsi a tutte le esigenze architettoniche e disponibile in diverse finiture e colori.



# 3

## SOLIDO e LEGGERO

Le barre d'acciaio corrono lungo i profili del piatto per mantenere una planarità ottimale a qualsiasi installazione.



# CUSTOM TOUCH

TECNOLOGIA  
E SEMPLICITÀ IN  
UN UNICO PIATTO.



◀ Piletta ispezionabile ad alta evacuazione (in dotazione)



◀ Effetto naturale della pietra



◀ Antiscivolo e caldo al tatto



Il primo piatto in acrilico al mondo, materico come la pietra. Antiscivolo e caldo al tatto, resistente agli urti, resistente ai raggi UV, facile da pulire.



CUSTOM TOUCH

# CUSTOM TOUCH

# CUSTOM TOUCH

APPOGGIO PAVIMENTO  
SPESSORE 3,5 CM



Bianco morbido

Beige

Corda

Grigio

Nero

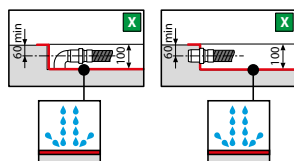
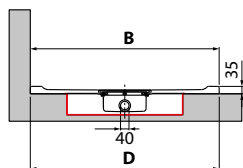
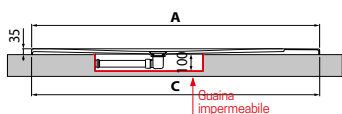
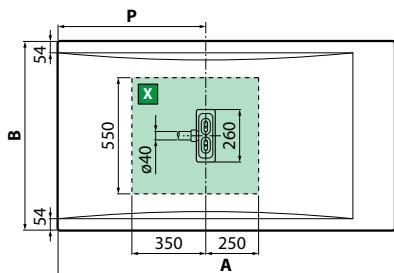

Misure				Codice	Scelta finitura / Prezzo				
AxB *	CxD **	P	79		11	27	29	28	
± 2 mm	** ± 3 mm		Bianco morbido	Beige	Corda	Grigio	Nero		
100 x 80	994 x 792	996 x 794	400	<b>CT100804-</b>	563 €	592 €	592 €	592 €	592 €
120 x 70	1194 x 692	1196 x 694	500	<b>CT120704-</b>	572 €	600 €	600 €	600 €	600 €
120 x 80	1194 x 792	1196 x 794	500	<b>CT120804-</b>	578 €	609 €	609 €	609 €	609 €
120 x 90	1194 x 892	1196 x 894	500	<b>CT120904-</b>	604 €	637 €	637 €	637 €	637 €
120 x 100	1194 x 992	1196 x 994	500	<b>CT120104-</b>	629 €	663 €	663 €	663 €	663 €
140 x 70	1392 x 692	1394 x 694	600	<b>CT140704-</b>	595 €	625 €	625 €	625 €	625 €
140 x 80	1392 x 792	1394 x 794	600	<b>CT140804-</b>	622 €	653 €	653 €	653 €	653 €
140 x 90	1392 x 892	1394 x 894	600	<b>CT140904-</b>	655 €	690 €	690 €	690 €	690 €
160 x 70	1592 x 692	1594 x 694	700	<b>CT160704-</b>	628 €	660 €	660 €	660 €	660 €
160 x 80	1592 x 792	1594 x 794	700	<b>CT160804-</b>	677 €	712 €	712 €	712 €	712 €
160 x 90	1592 x 892	1594 x 894	700	<b>CT160904-</b>	685 €	720 €	720 €	720 €	720 €
180 x 80	1792 x 792	1794 x 794	800	<b>CT180804-</b>	712 €	748 €	748 €	748 €	748 €
180 x 90	1792 x 892	1794 x 894	800	<b>CT180904-</b>	732 €	769 €	769 €	769 €	769 €

\* Misure della parte superiore del piatto  
\*\* Misure del piatto a pavimento

## INSTALLAZIONE A FILO PAVIMENTO



SOLO MODELLO SPESSORE 3,5 CM

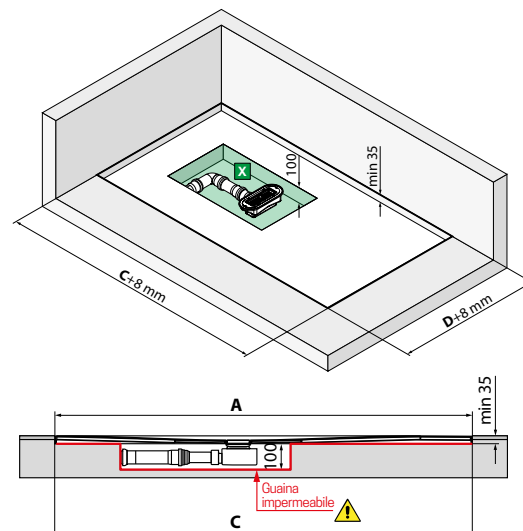

# CUSTOM TOUCH

APPOGGIO PAVIMENTO  
SPESSORE 12 CM



Bianco morbido

Beige

Corda

Grigio

Nero

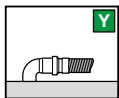
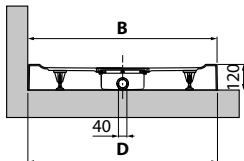
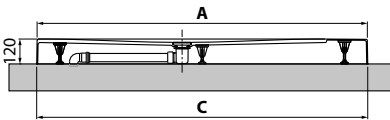
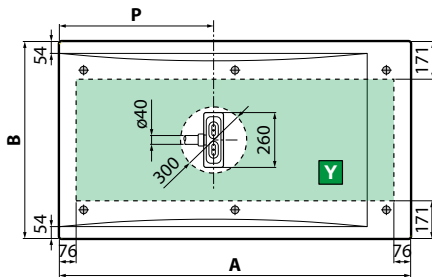

Misure				Codice	Scelta finitura / Prezzo				
	AxB *± 2 mm	CxD **± 3 mm	P		79 Bianco morbido	11 Beige	27 Corda	29 Grigio	28 Nero
100 x 80	994 x 792	1000 x 798	400	<b>CT1008011-</b>	563 €	592 €	592 €	592 €	592 €
120 x 70	1194 x 692	1200 x 698	500	<b>CT1207011-</b>	572 €	600 €	600 €	600 €	600 €
120 x 80	1194 x 792	1200 x 798	500	<b>CT1208011-</b>	578 €	609 €	609 €	609 €	609 €
120 x 90	1194 x 892	1200 x 898	500	<b>CT1209011-</b>	604 €	637 €	637 €	637 €	637 €
120 x 100	1194 x 992	1200 x 998	500	<b>CT1201011-</b>	629 €	663 €	663 €	663 €	663 €
140 x 70	1392 x 692	1398 x 698	600	<b>CT1407011-</b>	595 €	625 €	625 €	625 €	625 €
140 x 80	1392 x 792	1398 x 798	600	<b>CT1408011-</b>	622 €	653 €	653 €	653 €	653 €
140 x 90	1392 x 892	1398 x 898	600	<b>CT1409011-</b>	655 €	690 €	690 €	690 €	690 €
160 x 70	1592 x 692	1598 x 698	700	<b>CT1607011-</b>	628 €	660 €	660 €	660 €	660 €
160 x 80	1592 x 792	1598 x 798	700	<b>CT1608011-</b>	677 €	712 €	712 €	712 €	712 €
160 x 90	1592 x 892	1598 x 898	700	<b>CT1609011-</b>	685 €	720 €	720 €	720 €	720 €
180 x 80	1792 x 792	1798 x 798	800	<b>CT1808011-</b>	712 €	748 €	748 €	748 €	748 €
180 x 90	1792 x 892	1798 x 898	800	<b>CT1809011-</b>	732 €	769 €	769 €	769 €	769 €

- \* Misure della parte superiore del piatto
- \*\* Misure del piatto a pavimento

## OPTIONAL



**Kit 2 profili di finitura rigidi in plastica  
finitura bianco - 195 cm**

Codice	Prezzo
<b>PRVA195-30</b>	74 €

Costruzione del codice **Codice** + **Finitura** = Codice prodotto finale

# CUSTOM

TECNOLOGIA  
E SEMPLICITÀ IN  
UN UNICO PIATTO.



◀ Piletta ispezionabile ad alta  
evacuazione (in dotazione)

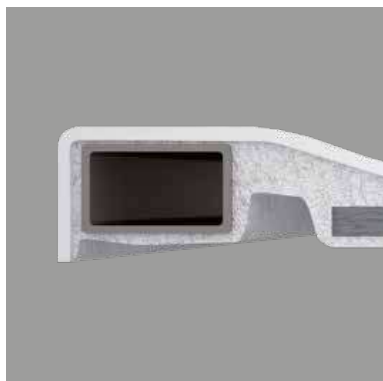

◀ Barre di rinforzo in acciaio  
Per piatto h. 3,5 mm



◀ Sagomabile per adattarsi  
a tutte le esigenze  
architettoniche  
Per piatto h. 3,5 mm

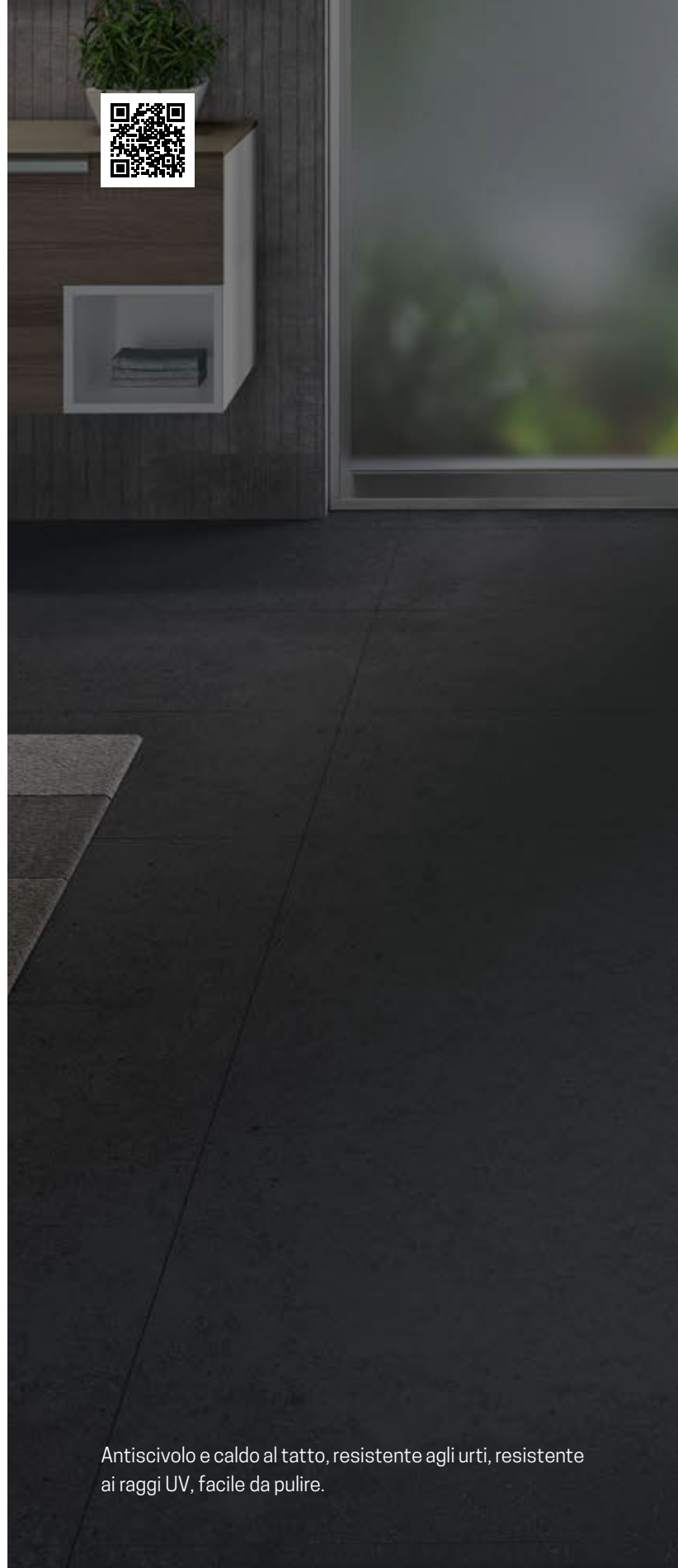

Antiscivolo e caldo al tatto, resistente agli urti, resistente ai raggi UV, facile da pulire.





CUSTOM

# CUSTOM

# CUSTOM

APPOGGIO PAVIMENTO  
SPESSORE 3,5 CM



Bianco

Bianco morbido

Beige

Corda

Grigio

Nero opaco

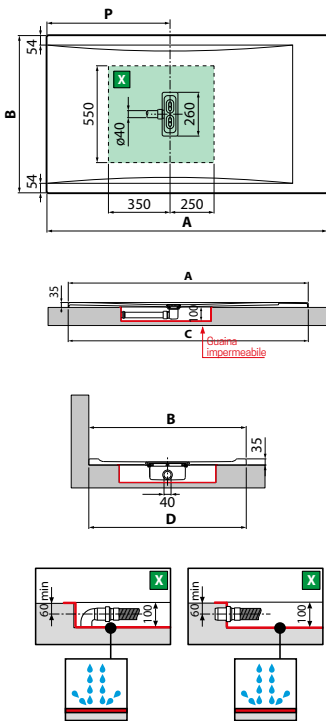

Misure				Fondo liscio Codice	Scelta finitura / Prezzo						Con antiscivolo Codice	Scelta finitura Prezzo
AxB*	CxD**	P			30	79	11	27	29	28		30
± 2 mm	± 3 mm				Bianco	bianco morbido	Beige	Corda	Grigio	Nero		Bianco
100 x 80	994 x 792	996 x 794	400	<b>CU100804-</b>	335 €	502 €	532 €	532 €	532 €	532 €	<b>CU100804A-</b>	468 €
120 x 70	1194 x 692	1196 x 694	500	<b>CU120704-</b>	343 €	509 €	537 €	537 €	537 €	537 €	<b>CU120704A-</b>	477 €
120 x 80	1194 x 792	1196 x 794	500	<b>CU120804-</b>	352 €	515 €	544 €	544 €	544 €	544 €	<b>CU120804A-</b>	483 €
120 x 90	1194 x 892	1196 x 894	500	<b>CU120904-</b>	373 €	539 €	568 €	568 €	568 €	568 €	<b>CU120904A-</b>	505 €
120 x 100	1194 x 992	1196 x 994	500	<b>CU120104-</b>	399 €	562 €	595 €	595 €	595 €	595 €	<b>CU120104A-</b>	530 €
140 x 70	1392 x 692	1394 x 694	600	<b>CU140704-</b>	365 €	530 €	558 €	558 €	558 €	558 €	<b>CU140704A-</b>	498 €
140 x 80	1392 x 792	1394 x 794	600	<b>CU140804-</b>	390 €	554 €	584 €	584 €	584 €	584 €	<b>CU140804A-</b>	522 €
140 x 90	1392 x 892	1394 x 894	600	<b>CU140904-</b>	419 €	585 €	618 €	618 €	618 €	618 €	<b>CU140904A-</b>	552 €
160 x 70	1592 x 692	1594 x 694	700	<b>CU160704-</b>	395 €	560 €	590 €	590 €	590 €	590 €	<b>CU160704A-</b>	527 €
160 x 80	1592 x 792	1594 x 794	700	<b>CU160804-</b>	438 €	603 €	634 €	634 €	634 €	634 €	<b>CU160804A-</b>	569 €
160 x 90	1592 x 892	1594 x 894	700	<b>CU160904-</b>	445 €	610 €	643 €	643 €	643 €	643 €	<b>CU160904A-</b>	578 €
180 x 80	1792 x 792	1794 x 794	800	<b>CU180804-</b>	468 €	633 €	667 €	667 €	667 €	667 €	<b>CU180804A-</b>	599 €
180 x 90	1792 x 892	1794 x 894	800	<b>CU180904-</b>	488 €	654 €	694 €	694 €	694 €	694 €	<b>CU180904A-</b>	620 €

\* Misure della parte superiore del piatto  
\*\* Misure del piatto a pavimento

## PER INSTALLAZIONE A FILO PAVIMENTO



SOLO MODELLO SPESSORE 3,5 CM

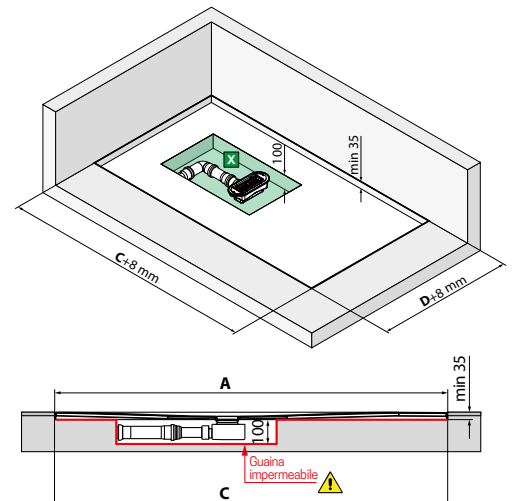

# CUSTOM

APPOGGIO PAVIMENTO  
SPESSORE 12 CM



Bianco

Bianco morbido

Beige

Corda

Grigio

Nero opaco

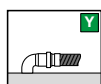
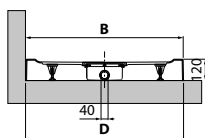
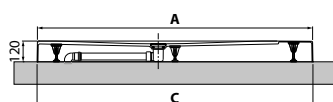
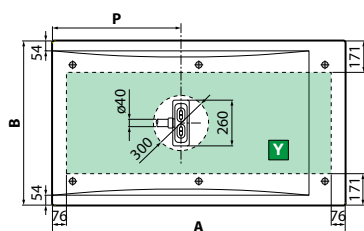

Misure	Fondo liscio Codice	Scelta finitura / Prezzo						Con antiscivolo Codice	Scelta finitura Prezzo			
		30	79	11	27	29	28			30		
<b>AxB* ± 2 mm</b>	<b>CxD **± 3 mm</b>	P	Bianco	Bianco morbido	Beige	Corda	Grigio	Nero	Bianco			
100 x 80	994 x 792	1000 x 798	400	<b>CU1008011-</b>	335 €	502 €	532 €	532 €	532 €	532 €	<b>CU1008011A-</b>	468 €
120 x 70	1194 x 692	1200 x 698	500	<b>CU1207011-</b>	343 €	509 €	537 €	537 €	537 €	537 €	<b>CU1207011A-</b>	477 €
120 x 80	1194 x 792	1200 x 798	500	<b>CU1208011-</b>	352 €	515 €	544 €	544 €	544 €	544 €	<b>CU1208011A-</b>	483 €
120 x 90	1194 x 892	1200 x 898	500	<b>CU1209011-</b>	373 €	539 €	568 €	568 €	568 €	568 €	<b>CU1209011A-</b>	505 €
120 x 100	1194 x 992	1200 x 998	500	<b>CU1201011-</b>	399 €	562 €	595 €	595 €	595 €	595 €	<b>CU1201011A-</b>	530 €
140 x 70	1392 x 692	1398 x 698	600	<b>CU1407011-</b>	365 €	530 €	558 €	558 €	558 €	558 €	<b>CU1407011A-</b>	498 €
140 x 80	1392 x 792	1398 x 798	600	<b>CU1408011-</b>	390 €	554 €	584 €	584 €	584 €	584 €	<b>CU1408011A-</b>	522 €
140 x 90	1392 x 892	1398 x 898	600	<b>CU1409011-</b>	419 €	585 €	618 €	618 €	618 €	618 €	<b>CU1409011A-</b>	552 €
160 x 70	1592 x 692	1598 x 698	700	<b>CU1607011-</b>	395 €	560 €	590 €	590 €	590 €	590 €	<b>CU1607011A-</b>	527 €
160 x 80	1592 x 792	1598 x 798	700	<b>CU1608011-</b>	438 €	603 €	634 €	634 €	634 €	634 €	<b>CU1608011A-</b>	569 €
160 x 90	1592 x 892	1598 x 898	700	<b>CU1609011-</b>	445 €	610 €	643 €	643 €	643 €	643 €	<b>CU1609011A-</b>	578 €
180 x 80	1792 x 792	1798 x 798	800	<b>CU1808011-</b>	468 €	633 €	667 €	667 €	667 €	667 €	<b>CU1808011A-</b>	599 €
180 x 90	1792 x 892	1798 x 898	800	<b>CU1809011-</b>	488 €	654 €	694 €	694 €	694 €	694 €	<b>CU1809011A-</b>	620 €

\* Misure della parte superiore del piatto

\*\* Misure del piatto a pavimento

## OPTIONAL



Kit 2 profili di finitura rigidi in plastica  
finitura bianco - 195 cm

Codice	Prezzo
<b>PRVA195-30</b>	74 €

Costruzione del codice **Codice** + **Finitura** = Codice prodotto finale

# OLYMPIC PLUS

PIATTO DOCCIA RINFORZATO  
CON PROFILI IN ACCIAIO



8 cm

## IN DOTAZIONE

Piletta di scarico  $\varnothing$  90  
inclusa nel prezzo

fondo liscio

Bianco  
(30)

Bianco morbido  
(79)

Beige  
(11)

Corda  
(27)

Grigio  
(29)

Nero  
(28)

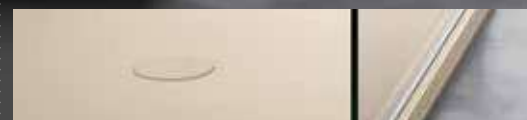
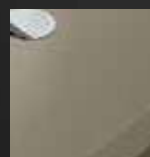
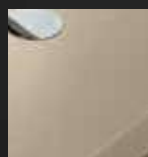

## OPTIONAL

Copripiletta colore del piatto

Finitura	Codice	Prezzo
Bianco	<b>KR90CPILOLP-30</b>	27 €
Bianco morbido	<b>KR90CPILOLP-79</b>	27 €
Beige	<b>KR90CPILOLP-11</b>	27 €
Corda	<b>KR90CPILOLP-27</b>	27 €
Nero	<b>KR90CPILOLP-28</b>	27 €
Grigio	<b>KR90CPILOLP-29</b>	27 €

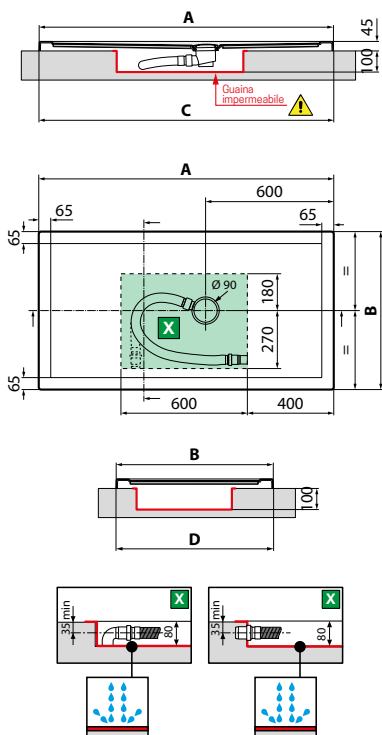

**X** Zona incassata a pavimento per lo scarico H 100 mm



\* Profilo di rinforzo in acciaio

# OLYMPIC PLUS

SPESORE 4,5 CM

Misure			Codice	Scelta finitura / Prezzo					
	AxB*	CxD**		30	79	11	27	29	28
	<b>AxB*</b> <b>± 2 mm</b>	<b>CxD**</b> <b>± 3 mm</b>		Bianco	Bianco morbido	Beige	Corda	Grigio	Nero
110 x 70	1094 x 692	1096 x 694	<b>OL110704-</b>	267 €	433 €			457 €	
110 x 80	1094 x 792	1096 x 794	<b>OL110804-</b>	273 €	439 €			464 €	
120 x 70	1194 x 692	1196 x 694	<b>OL120704-</b>	277 €	442 €			468 €	
120 x 80	1194 x 792	1196 x 794	<b>OL801204-</b>	283 €	448 €			477 €	
120 x 90	1194 x 892	1196 x 894	<b>OL120904-</b>	305 €	470 €			500 €	
120 x 100	1194 x 992	1196 x 994	<b>OL120104-</b>	324 €	489 €			519 €	
140 x 70	1392 x 692	1394 x 694	<b>OL140704-</b>	297 €	463 €			490 €	
140 x 75	1392 x 742	1394 x 744	<b>OL140754-</b>	297 €	463 €			490 €	
140 x 80	1392 x 792	1394 x 794	<b>OL140804-</b>	322 €	487 €			515 €	
140 x 90	1392 x 892	1394 x 894	<b>OL140904-</b>	353 €	518 €			549 €	
140 x 100	1392 x 992	1394 x 994	<b>OL140104-</b>	368 €	533 €			565 €	
150 x 70	1492 x 692	1494 x 694	<b>OL150704-</b>	308 €	472 €			502 €	
150 x 75	1492 x 742	1494 x 744	<b>OL150754-</b>	325 €	490 €			522 €	
160 x 70	1592 x 692	1594 x 694	<b>OL160704-</b>	327 €	492 €			523 €	
160 x 75	1592 x 742	1594 x 744	<b>OL160754-</b>	334 €	500 €			530 €	
160 x 80	1592 x 792	1594 x 794	<b>OL160804-</b>	369 €	534 €			567 €	
160 x 90	1592 x 892	1594 x 894	<b>OL160904-</b>	377 €	543 €			577 €	
170 x 70	1692 x 692	1694 x 694	<b>OL170704-</b>	338 €	504 €			534 €	
170 x 75	1692 x 742	1694 x 744	<b>OL170754-</b>	364 €	529 €			562 €	
170 x 80	1692 x 792	1694 x 794	<b>OL170804-</b>	374 €	540 €			574 €	
170 x 90	1692 x 892	1694 x 894	<b>OL170904-</b>	398 €	563 €			597 €	
180 x 75	1792 x 742	1794 x 744	<b>OL180754-</b>	379 €	545 €			579 €	
180 x 80	1792 x 792	1794 x 794	<b>OL180804-</b>	400 €	565 €			599 €	
180 x 90	1792 x 892	1794 x 894	<b>OL180904-</b>	423 €	588 €			624 €	

OLYMPIC PLUS

# OLYMPIC PLUS

SPESORE 12,5 CM

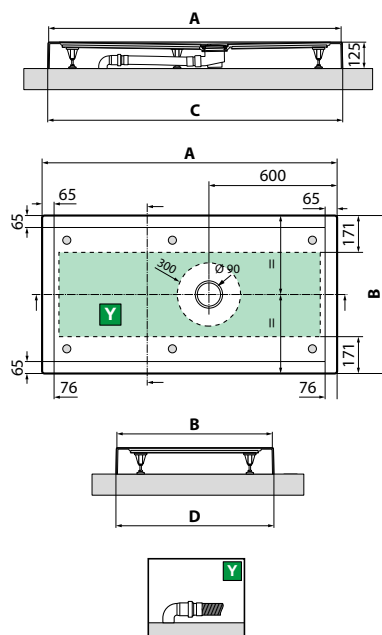

**Y** Zona disponibile per lo scarico sopra pavimento

Misure			Codice	Scelta finitura / Prezzo					
	AxB*	CxD**		30	79	11	27	29	28
	<b>AxB*</b> <b>± 2 mm</b>	<b>CxD**</b> <b>± 3 mm</b>		Bianco	Bianco morbido	Beige	Corda	Grigio	Nero
110 x 70	1094 x 692	1100 x 698	<b>OL1107011-</b>	267 €	433 €			457 €	
110 x 80	1094 x 792	1100 x 798	<b>OL1108011-</b>	273 €	439 €			464 €	
120 x 70	1194 x 692	1200 x 698	<b>OL1207011-</b>	277 €	442 €			468 €	
120 x 80	1194 x 792	1200 x 798	<b>OL8012011-</b>	283 €	448 €			477 €	
120 x 90	1194 x 892	1200 x 898	<b>OL1209011-</b>	305 €	470 €			500 €	
120 x 100	1194 x 992	1200 x 998	<b>OL1201011-</b>	324 €	489 €			519 €	
140 x 70	1392 x 692	1398 x 698	<b>OL1407011-</b>	297 €	463 €			490 €	
140 x 75	1392 x 742	1398 x 748	<b>OL1407511-</b>	297 €	463 €			490 €	
140 x 80	1392 x 792	1398 x 798	<b>OL1408011-</b>	322 €	487 €			515 €	
140 x 90	1392 x 892	1398 x 898	<b>OL1409011-</b>	353 €	518 €			549 €	
140 x 100	1392 x 992	1398 x 998	<b>OL1401011-</b>	368 €	533 €			565 €	
150 x 70	1492 x 692	1498 x 698	<b>OL1507011-</b>	308 €	472 €			502 €	
150 x 75	1492 x 742	1498 x 748	<b>OL1507511-</b>	325 €	490 €			522 €	
160 x 70	1592 x 692	1598 x 698	<b>OL1607011-</b>	327 €	492 €			523 €	
160 x 75	1592 x 742	1598 x 748	<b>OL1607511-</b>	334 €	500 €			530 €	
160 x 80	1592 x 792	1598 x 798	<b>OL1608011-</b>	369 €	534 €			567 €	
160 x 90	1592 x 892	1598 x 898	<b>OL1609011-</b>	377 €	543 €			577 €	
170 x 70	1692 x 692	1698 x 698	<b>OL1707011-</b>	338 €	504 €			534 €	
170 x 75	1692 x 742	1698 x 748	<b>OL1707511-</b>	364 €	529 €			562 €	
170 x 80	1692 x 792	1698 x 798	<b>OL1708011-</b>	374 €	540 €			574 €	
170 x 90	1692 x 892	1698 x 898	<b>OL1709011-</b>	398 €	563 €			597 €	
180 x 75	1792 x 742	1798 x 748	<b>OL1807511-</b>	379 €	545 €			579 €	
180 x 80	1792 x 792	1798 x 798	<b>OL1808011-</b>	400 €	565 €			599 €	
180 x 90	1792 x 892	1798 x 898	<b>OL1809011-</b>	423 €	588 €			624 €	

Costruzione del codice

Codice

+

Finitura

= Codice prodotto finale

\* Misure della parte superiore del piatto  
\*\* Misure del piatto a pavimento



# OLYMPIC

## PIATTO DOCCIA QUADRATO O RETTANGOLARE



fondo liscio



### OPTIONAL

Piletta di scarico  $\varnothing$  90  
non fornita

Codice	Prezzo
<b>PIL90PCAB-CR40</b>	37 €

Per una ottimale tenuta si consiglia l'uso della nostra piletta di scarico **PIL90PCAB-CR40**, oppure di pilette di scarico dotate di guarnizione a doppio labbro

Bianco  
(30)

Bianco morbido  
(79)

Beige  
(11)

Corda  
(27)

Grigio  
(29)

Nero  
(28)

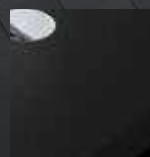
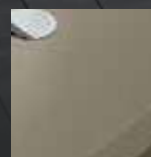
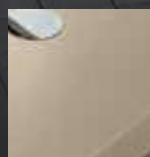

### OPTIONAL

Copripiletta colore del piatto

Finitura	Codice	Prezzo
Bianco	<b>KR90CPILOLP-30</b>	27 €
Bianco morbido	<b>KR90CPILOLP-79</b>	27 €
Beige	<b>KR90CPILOLP-11</b>	27 €
Corda	<b>KR90CPILOLP-27</b>	27 €
Nero	<b>KR90CPILOLP-28</b>	27 €
Grigio	<b>KR90CPILOLP-29</b>	27 €

# OLYMPIC

SPESORE 4,5 CM

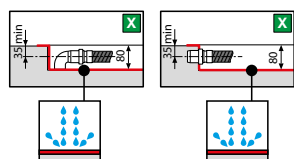
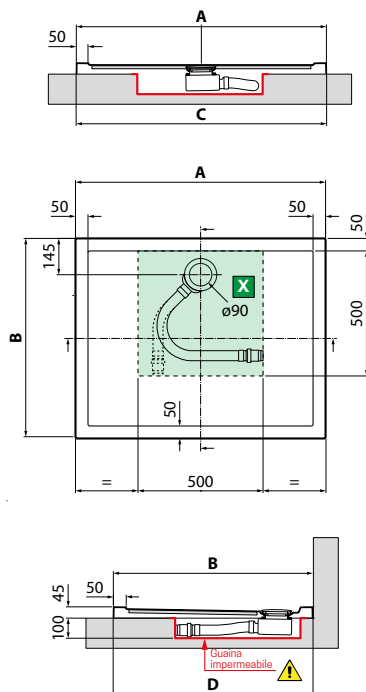

Misure			Codice	Scelta finitura / Prezzo					
	AxB* ± 2 mm	CxD** ± 3 mm		30	79	11	27	29	28
				Bianco	Bianco morbido	Beige	Corda	Grigio	Nero
80 x 80	794 x 794	796 x 796	<b>OLN804-</b>	219 €	379 €			400 €	
90 x 90	894 x 894	896 x 896	<b>OLN904-</b>	238 €	399 €			420 €	
100 x 100	994 x 994	996 x 996	<b>OLN1004-</b>	263 €	423 €			445 €	
90 x 70	894 x 694	896 x 696	<b>OLN90704-</b>	225 €	385 €			407 €	
90 x 75	894 x 744	896 x 746	<b>OLN90754-</b>	238 €	399 €			420 €	
100 x 70	994 x 694	996 x 696	<b>OLN100704-</b>	250 €	412 €			433 €	
100 x 80	994 x 794	996 x 796	<b>OLN100804-</b>	257 €	418 €			439 €	
120 x 80	1194 x 794	1196 x 796	<b>OLN120804-</b>	263 €	423 €			445 €	
120 x 90	1194 x 894	1196 x 896	<b>OLN120904-</b>	288 €	448 €			472 €	

- \* Misure della parte superiore del piatto
- \*\* Misure del piatto a pavimento



\* Profilo di rinforzo in acciaio

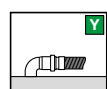
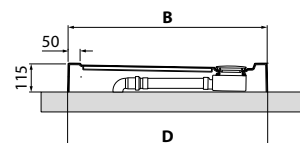
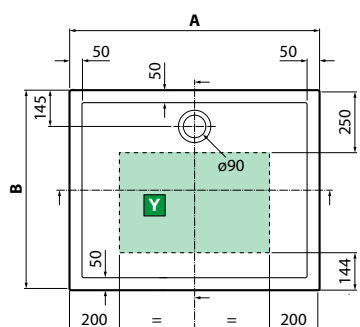
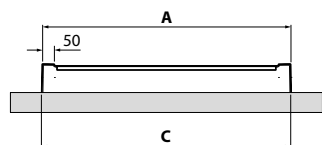

# OLYMPIC

SPESORE 11,5 CM

Misure			Codice	Scelta finitura / Prezzo					
	AxB* ± 2 mm	CxD** ± 3 mm		30	79	11	27	29	28
				Bianco	Bianco morbido	Beige	Corda	Grigio	Nero
80 x 80	794 x 794	798 x 798	<b>OLN8011-</b>	219 €	379 €			400 €	
90 x 90	894 x 894	898 x 898	<b>OLN9011-</b>	238 €	399 €			420 €	
100 x 100	994 x 994	998 x 998	<b>OLN10011-</b>	263 €	423 €			445 €	
90 x 70	894 x 694	898 x 698	<b>OLN907011-</b>	225 €	385 €			407 €	
90 x 75	894 x 744	898 x 748	<b>OLN907511-</b>	238 €	399 €			420 €	
100 x 70	994 x 694	998 x 698	<b>OLN1007011-</b>	250 €	412 €			433 €	
100 x 80	994 x 794	998 x 798	<b>OLN1008011-</b>	257 €	418 €			439 €	
120 x 80	1194 x 794	1198 x 798	<b>OLN1208011-</b>	263 €	423 €			445 €	
120 x 90	1194 x 894	1198 x 898	<b>OLN1209011-</b>	288 €	448 €			472 €	

- \* Misure della parte superiore del piatto
- \*\* Misure del piatto a pavimento



OLYMPIC

# VICTORY

## PIATTO DOCCIA SEMICIRCOLARE



fondo liscio



### OPTIONAL

Piletta di scarico ø 90  
non fornita

Codice	Prezzo
PIL90PCAB-CR40	37 €

Per una ottimale tenuta si consiglia l'uso della nostra piletta di scarico **PIL90PCAB-CR40**, oppure di pilette di scarico dotate di guarnizione a doppio labbro

Bianco  
(30)

Bianco morbido  
(79)

Beige  
(11)

Corda  
(27)

Grigio  
(29)

Nero  
(28)



### OPTIONAL

Copripiletta colore del piatto

Finitura	Codice	Prezzo
Bianco	<b>KR90CPILOLP-30</b>	27 €
Bianco morbido	<b>KR90CPILOLP-79</b>	27 €
Beige	<b>KR90CPILOLP-11</b>	27 €
Corda	<b>KR90CPILOLP-27</b>	27 €
Nero	<b>KR90CPILOLP-28</b>	27 €
Grigio	<b>KR90CPILOLP-29</b>	27 €





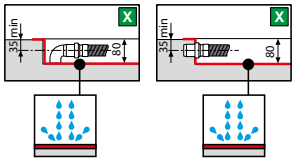
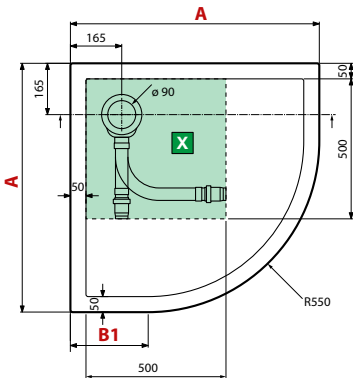
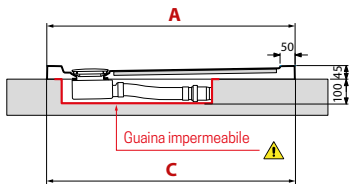

# VICTORY

SPESSORE 4,5 CM

Misure	Codice	Scelta finitura / Prezzo					
		30	79	11	27	29	28
		Bianco	Bianco morbido	Beige	Corda	Grigio	Nero
80 x 80	<b>VINR804-</b>	269 €	439 €	462 €	462 €	462 €	462 €
90 x 90	<b>VINR904-</b>	287 €	458 €	482 €	482 €	482 €	482 €
100 x 100	<b>VINR1004-</b>	300 €	472 €	495 €	495 €	495 €	495 €

- \* Misure della parte superiore del piatto
- \*\* Misure del piatto a pavimento

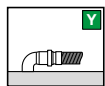
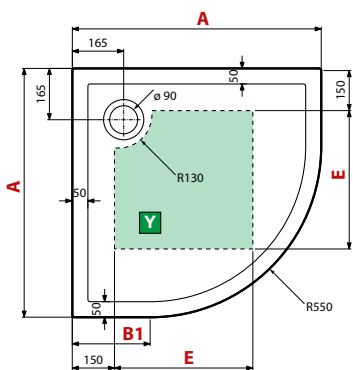
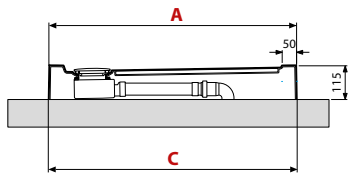

# VICTORY

SPESSORE 11,5 CM

Misure	Codice	Scelta finitura / Prezzo					
		30	79	11	27	29	28
		Bianco	Bianco morbido	Beige	Corda	Grigio	Nero
80 x 80	<b>VINR8011-</b>	269 €	439 €	462 €	462 €	462 €	462 €
90 x 90	<b>VINR9011-</b>	287 €	458 €	482 €	482 €	482 €	482 €
100 x 100	<b>VINR10011-</b>	300 €	472 €	495 €	495 €	495 €	495 €

- \* Misure della parte superiore del piatto
- \*\* Misure del piatto a pavimento

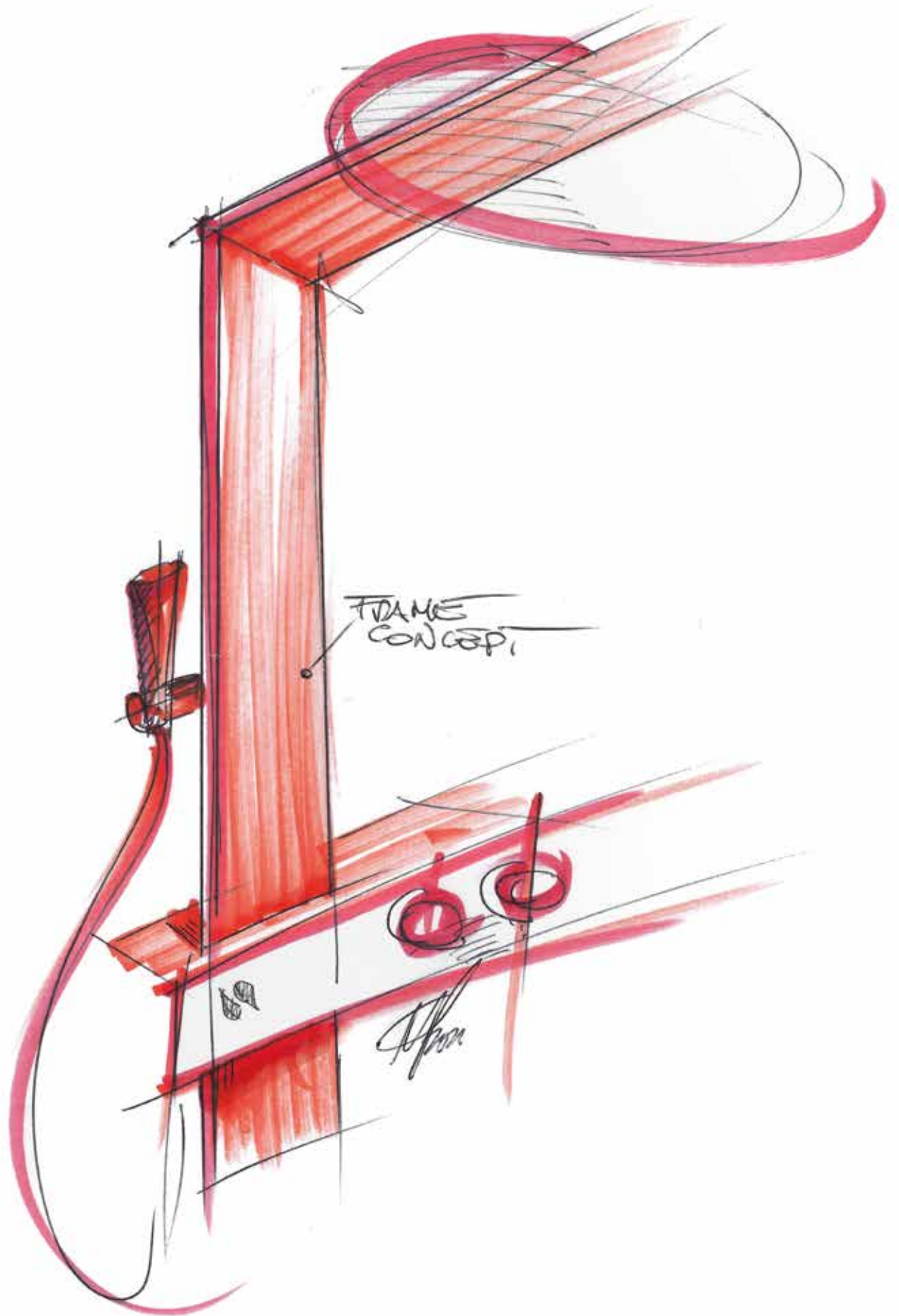

- 346 F
- 347 Z
- 348 Line
- 350 Easy
- 351 Revif
- 352 Dress
- 355 Vanity



# COLONNE DOCCIA

IL COMPLEMENTO  
GIUSTO ALLA TUA  
DOCCIA - SIGNIFICA  
BENESSERE.

La rivoluzione in poche e semplici mosse. Le colonne doccia Novellini completano con estrema facilità lo spazio bagno, aggiungendo la nota di benessere che mancava, per concederti ogni giorno un'esperienza doccia da sogno grazie all'idromassaggio incorporato. Design essenziale e raffinato, montaggio a parete o in angolo e un'infinità di dettagli che fanno la differenza.

# F

## COLONNA ATTREZZATA CON SOFFIONE, INSTALLABILE A PARETE



NELLE FINITURE BIANCO OPACO E SILVER  
RUBINETTERIA, DOCCETTA E SOFFIONE SONO CROMATI

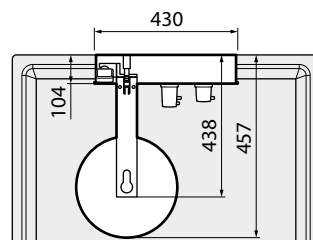
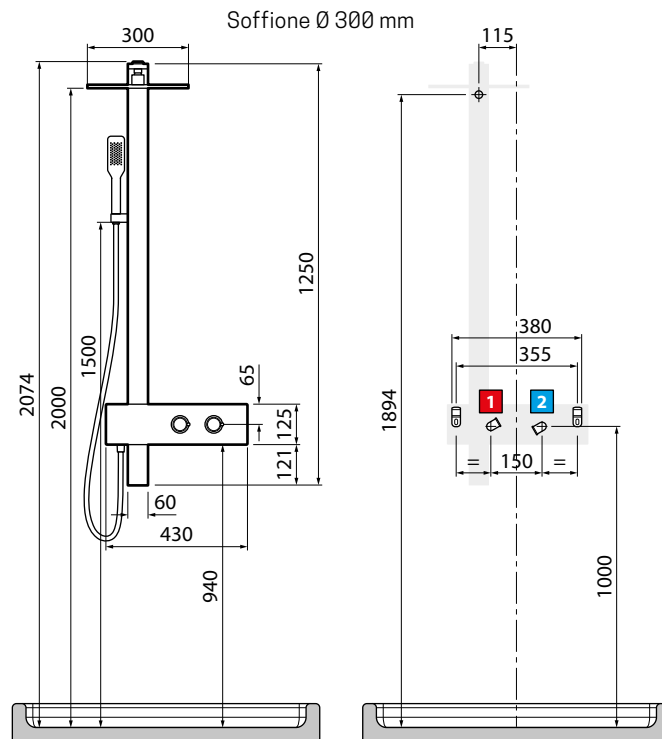

Miscelatore	Misure (cm)	Codice	Finitura		
			<b>U</b>	<b>H</b>	<b>B</b>
			Bianco opaco	Nero opaco	Silver

STANDARD						
Meccanico	42x8,4x125	<b>EFFEM-</b>	1.143 €	1.485 €	1.314 €	
Termostatico	42x8,4x125	<b>EFFET-</b>	1.225 €	1.568 €	1.397 €	

# Z

## COLONNA ATTREZZATA, INSTALLABILE AD ANGOLO E A PARETE

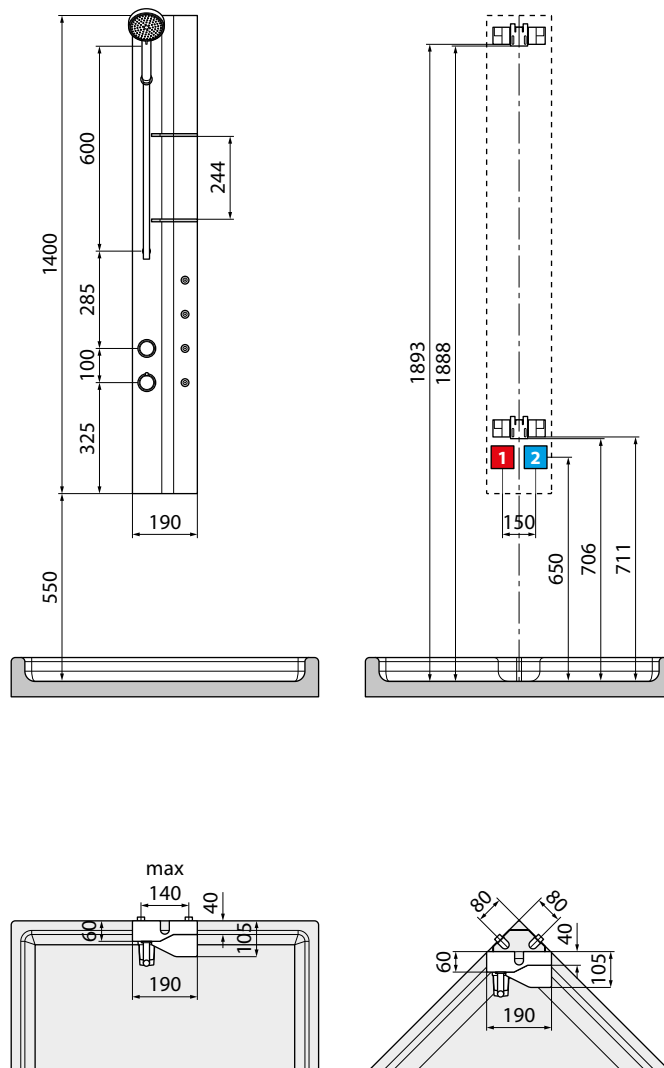

COLONNE DOCCIA

Miscelatore	Misure (cm)	Codice	Finitura		
			<b>U</b>	<b>H</b>	<b>B</b>
			Bianco opaco	Nero opaco	Silver

STANDARD					
Meccanico	19x6x140	<b>ZETAM-</b>	788 €	867 €	867 €
Termostatico	19x6x140	<b>ZETAT-</b>	870 €	949 €	949 €

IDROMASSAGGIO					
Meccanico	19x6x140	<b>ZETAVM-</b>	1.025 €	1.104 €	1.104 €
Termostatico	19x6x140	<b>ZETAVT-</b>	1.108 €	1.187 €	1.187 €

Costruzione del codice **Codice** + **Finitura** = Codice prodotto finale



# LINE 1

## COLONNA ATTREZZATA IN ALLUMINIO CON SOFFIONE, INSTALLABILE A PARETE E AD ANGOLO

Design Marco Pellici

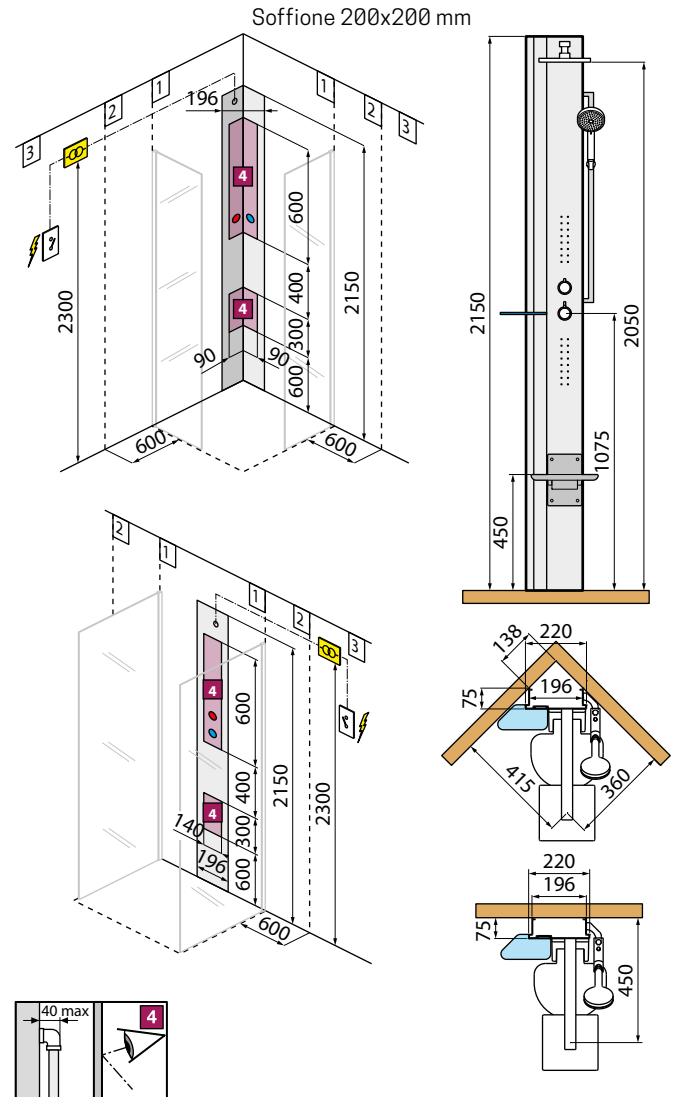

Miscelatore	Misure (cm)	Codice	Scelta finitura / Prezzo							
			Silver	Tortora	Argento	Tortora	Nero opaco	Nero opaco	Bianco opaco	
			<b>COLONNA BIANCO OPACO</b>		<b>COLONNA NERO OPACO</b>		<b>COLONNA ARGENTO</b>		<b>COLONNA SILVER</b>	
			FASCIA E MENSOLA		FASCIA E MENSOLA		FASCIA E MENSOLA		FASCIA E MENSOLA	
			<b>UB</b>	<b>UN2</b>	<b>HJ</b>	<b>HN2</b>	<b>JH</b>	<b>BH</b>	<b>BU</b>	
			Silver	Tortora	Argento	Tortora	Nero opaco	Nero opaco	Bianco opaco	

SENZA SEDILE									
Meccanico	22 x 7,5 x H215	<b>LINE1M-</b>	1.240 €	1.240 €	1.392 €	1.392 €	1.325 €	1.392 €	1.392 €
Termostatico	22 x 7,5 x H215	<b>LINE1T-</b>	1.320 €	1.320 €	1.472 €	1.472 €	1.405 €	1.472 €	1.472 €

IDROMASSAGGIO CON SEDILE									
			Sedile bianco		Sedile nero opaco		Sedile nero opaco	Sedile nero opaco	Sedile bianco
Meccanico	22 x 7,5 x H215	<b>LINE1PVM-</b>	1.722 €	1.722 €	1.872 €	1.872 €	1.807 €	1.872 €	1.872 €
Termostatico	22 x 7,5 x H215	<b>LINE1PVT-</b>	1.800 €	1.800 €	1.952 €	1.952 €	1.885 €	1.952 €	1.952 €

LIGHT									
			Sedile bianco		Sedile nero opaco		Sedile nero opaco	Sedile nero opaco	Sedile bianco
Meccanico	22 x 7,5 x H215	<b>LINE1PVML-</b>	2.040 €	2.040 €	2.192 €	2.192 €	2.125 €	2.192 €	2.192 €
Termostatico	22 x 7,5 x H215	<b>LINE1PRTL-</b>	2.120 €	2.120 €	2.270 €	2.270 €	2.205 €	2.270 €	2.270 €

1 2 Allacci per rubinetteria



### CARATTERISTICHE IDRAULICHE

- Pressione dinamica ottimale 2÷5 bar
- Acqua calda 1/2"
- Acqua fredda 1/2"

### CARATTERISTICHE ELETTRICHE

- 220-230 V
- 50/60 Hz
- Potenza nominale: 25 W

Installare a monte dell'apparecchio un interruttore differenziale da 30mA provvisto di interruttore onnipolare con apertura minima dei contatti ≥ 3 mm.

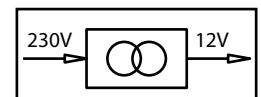

# LINE 2

COLONNA ATTREZZATA IN ALLUMINIO CON SOFFIONE, INSTALLABILE A PARETE O AD ANGOLO



FINITURA NERO OPACO / SILVER

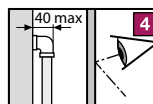
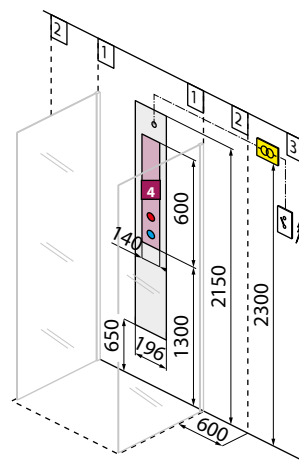
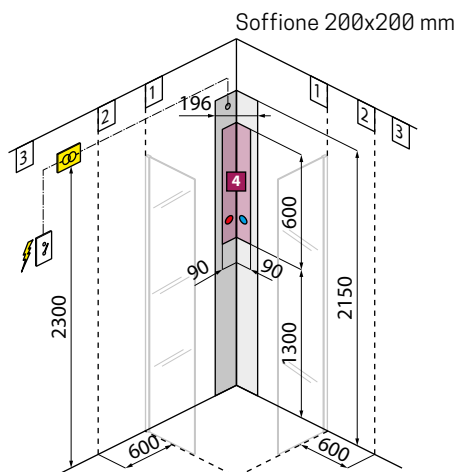

Soffione 200x200 mm

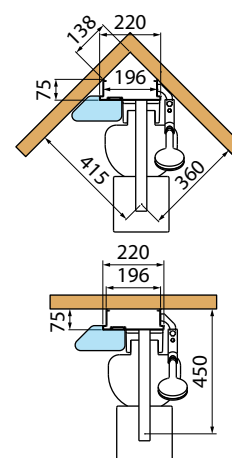
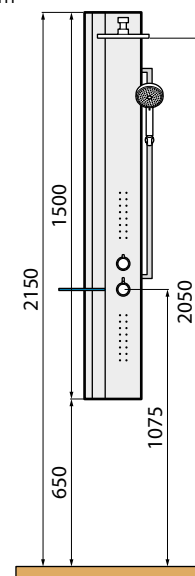

COLONNE DOCCIA

Miscelatore	Misure (cm)	Codice	Scelta finitura / Prezzo						
			Silver	Tortora	Argento	Tortora	Nero opaco	Nero opaco	Bianco opaco
			<b>COLONNA BIANCO OPACO</b>		<b>COLONNA NERO OPACO</b>		<b>COLONNA ARGENTO</b>	<b>COLONNA SILVER</b>	
			FASCIA E MENSOLA		FASCIA E MENSOLA		FASCIA E MENSOLA	FASCIA E MENSOLA	
			<b>UB</b>	<b>UN2</b>	<b>HJ</b>	<b>HN2</b>	<b>JH</b>	<b>BH</b> <b>BU</b>	
			Silver	Tortora	Argento	Tortora	Nero opaco	Nero opaco	Bianco opaco
<b>STANDARD</b>									
Meccanico	22 x 7,5 x H150	<b>LINE2M-</b>	1.148 €	1.148 €	1.288 €	1.288 €	1.228 €	1.288 €	1.288 €
Termostatico	22 x 7,5 x H150	<b>LINE2T-</b>	1.228 €	1.228 €	1.368 €	1.368 €	1.308 €	1.368 €	1.368 €
<b>IDROMASSAGGIO</b>									
Meccanico	22 x 7,5 x H150	<b>LINE2VM-</b>	1.334 €	1.334 €	1.475 €	1.475 €	1.414 €	1.475 €	1.475 €
Termostatico	22 x 7,5 x H150	<b>LINE2VT-</b>	1.414 €	1.414 €	1.555 €	1.555 €	1.494 €	1.555 €	1.555 €
<b>LIGHT</b>									
Meccanico	22 x 7,5 x H150	<b>LINE2VML-</b>	1.654 €	1.654 €	1.795 €	1.795 €	1.734 €	1.795 €	1.795 €
Termostatico	22 x 7,5 x H150	<b>LINE2VTL-</b>	1.734 €	1.734 €	1.875 €	1.875 €	1.814 €	1.875 €	1.875 €

1 2 Allacci per rubinetteria



CARATTERISTICHE IDRAULICHE

- Pressione dinamica ottimale 2÷5 bar
- Acqua calda 1/2"
- Acqua fredda 1/2"

CARATTERISTICHE ELETTRICHE

- 220-230 V
- 50/60 Hz
- Potenza nominale: 25 W

Installare a monte dell'apparecchio un interruttore differenziale da 30mA provvisto di interruttore onnipolare con apertura minima dei contatti ≥ 3mm.

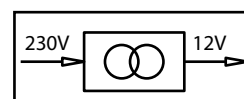

Costruzione del codice **Codice** + **Finitura** = Codice prodotto finale





# EASY 2

**COLONNA ATTREZZATA IN OTTONE CROMATO CON SOFFIONE, INSTALLABILE A PARETE**

Miscelatore	Misure (cm)	Codice	Prezzo	
			K	H
			Cromo	Nero opaco

Termostatico	29 x H 125	<b>EASY2T-</b>	655 €	884 €

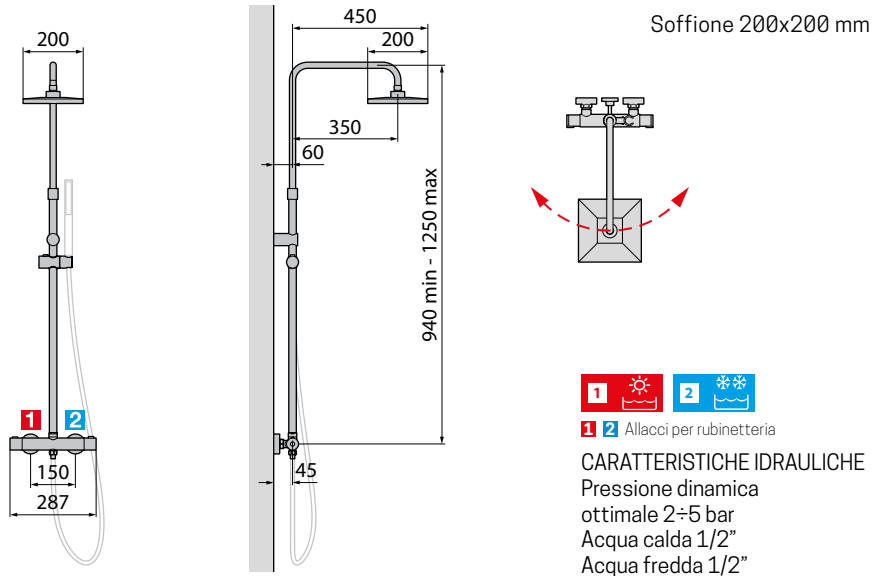

# EASY 2R

**COLONNA ATTREZZATA IN OTTONE CROMATO CON SOFFIONE, INSTALLABILE A PARETE**

Miscelatore	Misure (cm)	Codice	Prezzo	
			K	H
			Cromo	Nero opaco

Termostatico	29 x H 125	<b>EASY2R-</b>	754 €	1.018 €

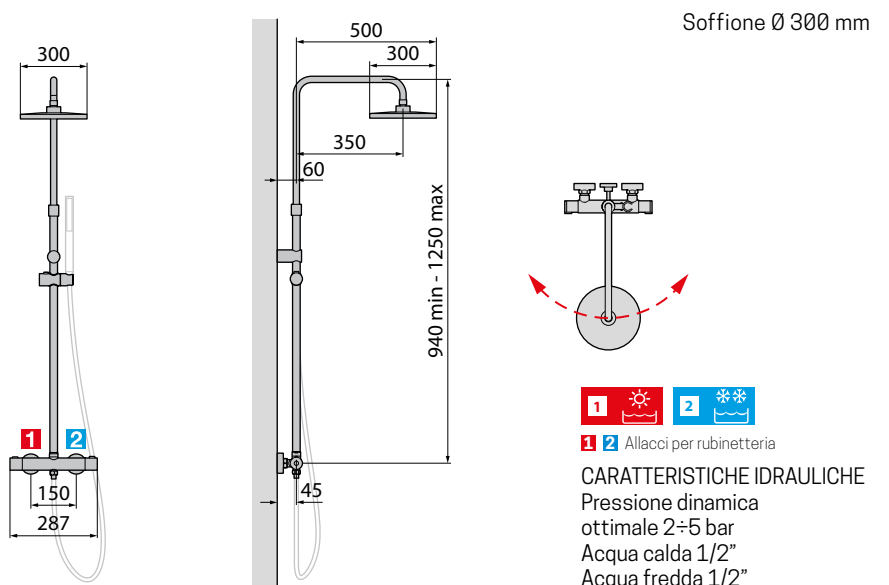





# REVIF

**COLONNA ATTREZZATA IN ACCIAIO INOX LUCIDO SUPER MIRROR, INSTALLABILE A PARETE**

Miscelatore	Misure (cm)	Codice	Prezzo
Meccanico	10 X H 118	<b>REV1M-K</b>	580 €
Termostatico	10 X H 118	<b>REV1T-K</b>	670 €

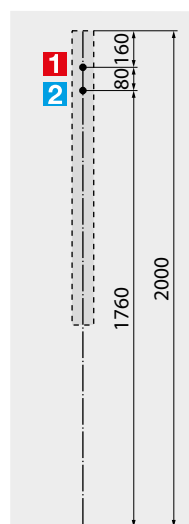
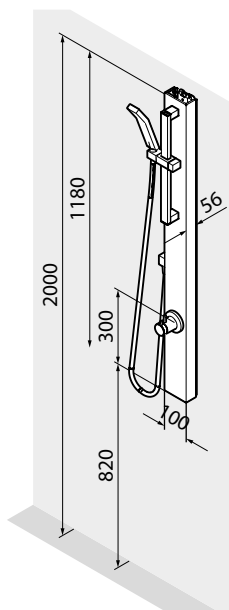

1 2 Allacci per rubinetteria

**CARATTERISTICHE IDRAULICHE**  
 Pressione dinamica ottimale 2÷5 bar  
 Acqua calda 1/2"  
 Acqua fredda 1/2"

COLONNE DOCCIA



# REVIF PLUS

**COLONNA ATTREZZATA IN ACCIAIO INOX LUCIDO SUPER MIRROR E SOFFIONE, INSTALLABILE A PARETE**

Miscelatore	Misure (cm)	Codice	Prezzo
Meccanico	10 X H 118	<b>REV1VM-K</b>	928 €
Termostatico	10 X H 118	<b>REV1VT-K</b>	1.005 €

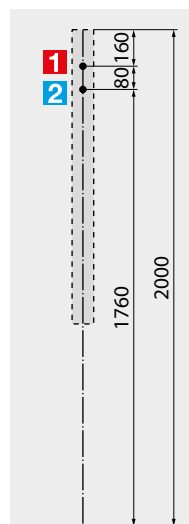
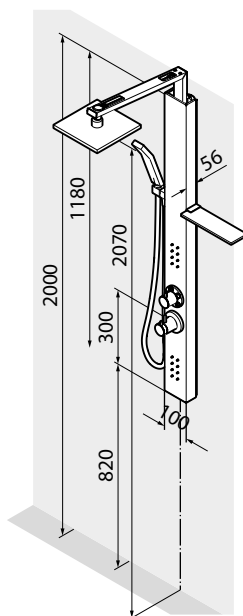

1 2 Allacci per rubinetteria

**CARATTERISTICHE IDRAULICHE**  
 Pressione dinamica ottimale 2÷5 bar  
 Acqua calda 1/2"  
 Acqua fredda 1/2"

Costruzione del codice **Codice** + **Finitura** = Codice prodotto finale

# DRESS PLUS

COLONNA ATTREZZATA CON SOFFIONE, INSTALLABILE A PARETE

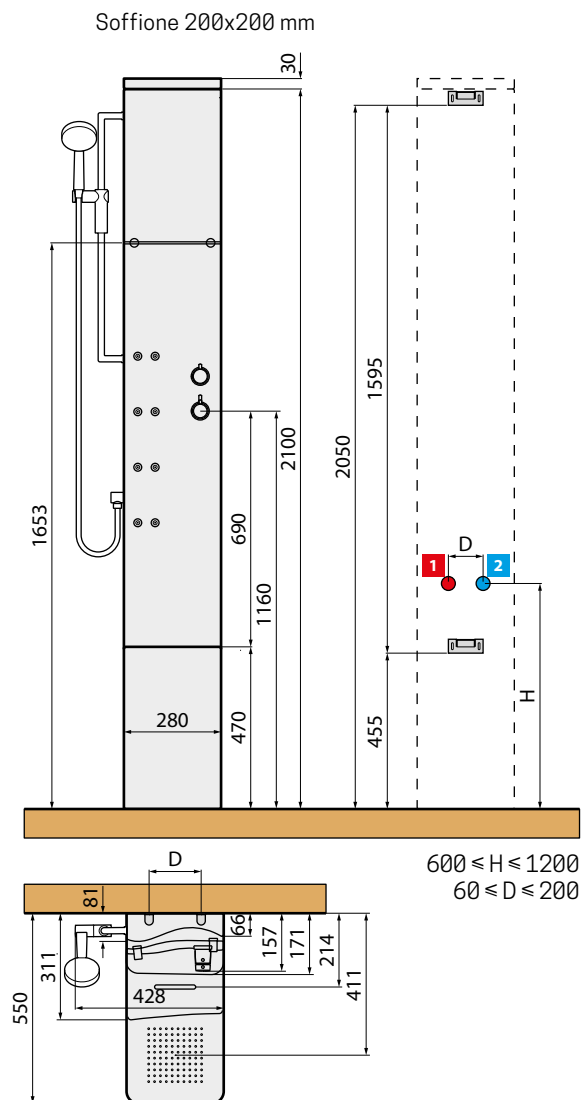

Miscelatore	Misure (cm)	Codice	Scelta finitura / Prezzo			
			30	79	29	28
			Bianco lucido	Bianco opaco	Grigio	Nero opaco
<b>STANDARD</b>						
Meccanico	28 x 55 x H 213	<b>DRESS1VMF-</b>	1.624 €	1.679 €	1.732 €	1.732 €
Termostatico	28 x 55 x H 213	<b>DRESS1VTF-</b>	1.707 €	1.762 €	1.814 €	1.814 €

1 2 Allacci per rubinetteria



**CARATTERISTICHE IDRAULICHE**  
Pressione dinamica ottimale 2÷5 bar  
Acqua calda 1/2"  
Acqua fredda 1/2"

# DRESS S

COLONNA ATTREZZATA CON SOFFIONE, INSTALLABILE A PARETE



Soffione 200x200 mm

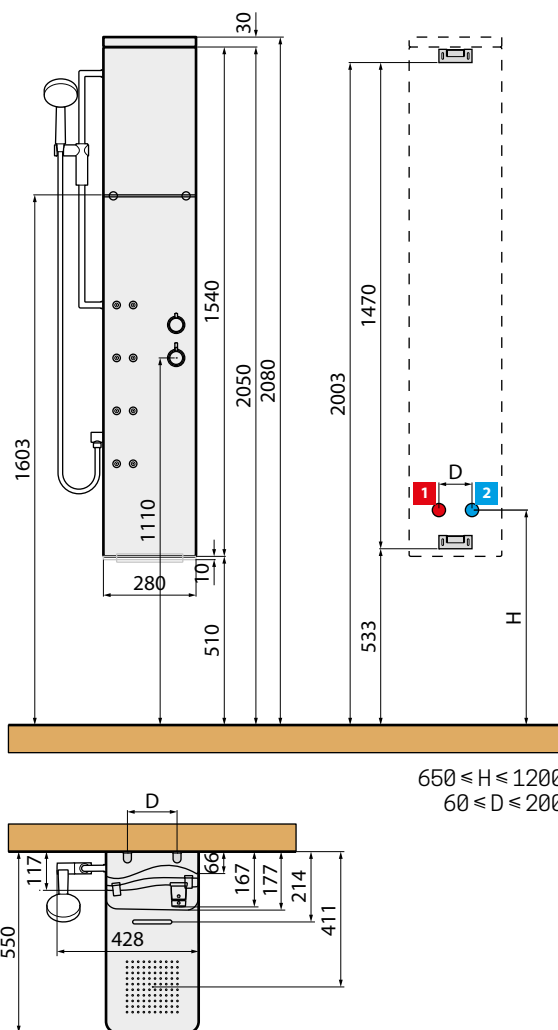

COLONNE DOCCIA

Miscelatore	Misure (cm)	Codice	Scelta finitura / Prezzo			
			30	79	29	28
			Bianco lucido	Bianco opaco	Grigio	Nero opaco

STANDARD						
Meccanico	28 x 55 x H 158	<b>DRESS2VMF-</b>	1.305 €	1.358 €	1.412 €	1.412 €
Termostatico	28 x 55 x H 158	<b>DRESS2VTF-</b>	1.388 €	1.440 €	1.494 €	1.494 €

## OPTIONAL



### POGGIPIEDI

Codice	Prezzo
<b>POGPDRE</b>	<b>102 €</b>

1 2 Allacci per rubinetteria

- 1** **CARATTERISTICHE IDRAULICHE**  
Pressione dinamica ottimale 2÷5 bar  
Acqua calda 1/2"
- 2** **Acqua fredda 1/2"**

Costruzione del codice **Codice** + **Finitura** = Codice prodotto finale

# DRESS

COLONNA ATTREZZATA CON SOFFIONE, INSTALLABILE A PARETE

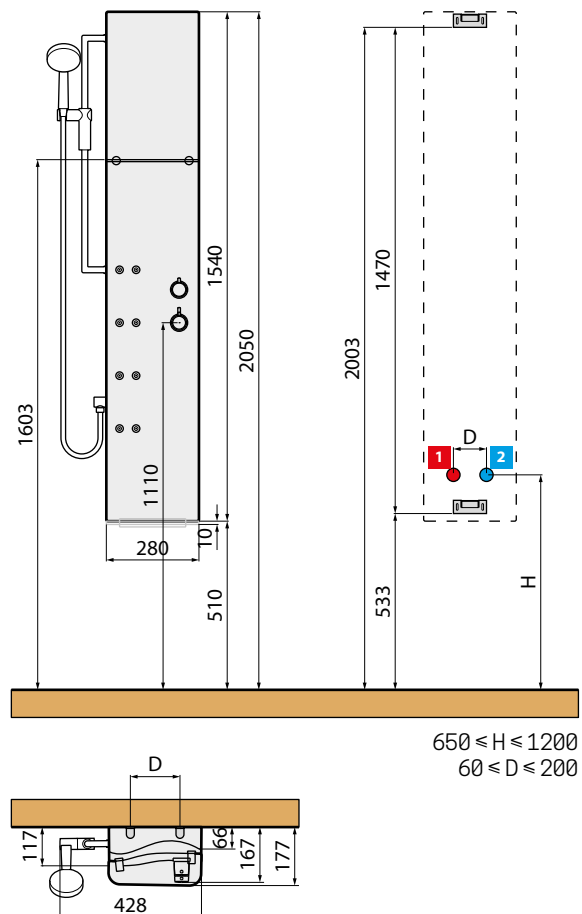

Miscelatore	Misure (cm)	Codice	Scelta finitura / Prezzo			
			30	79	29	28
			Bianco lucido	Bianco opaco	Grigio	Nero opaco

STANDARD						
Meccanico	28 x 17 x H 154	<b>DRESS2VM-</b>	1.052 €	1.104 €	1.158 €	1.158 €
Termostatico	28 x 17 x H 154	<b>DRESS2VT-</b>	1.134 €	1.188 €	1.240 €	1.240 €

## OPTIONAL



### POGGIPIEDI

Codice	Prezzo
<b>POGPDRE</b>	<b>102 €</b>

**1 2** Allacci per rubinetteria



**CARATTERISTICHE IDRAULICHE**  
Pressione dinamica ottimale 2÷5 bar  
Acqua calda 1/2"



Acqua fredda 1/2"







- 359 Skill
- 367 Glax 1
- 379 Glax 2
- 391 Crystal
- 399 Eon
- 413 New Holiday
- 427 Media Glass
- 435 Media
- 457 Revolution



# CABINE DOCCIA

LA PIÙ INCREDIBILE  
ESPERIENZA DOCCIA  
È CUSTODITA NELLE  
CABINE NOVELLINI.

Comode, funzionali e personalizzabili, queste affascinanti soluzioni di design accostano all'estetica ricercata l'aspetto multifunzionale e multisensoriale per soddisfare il desiderio di relax. Facili da mantenere e da utilizzare, le cabine doccia Novellini sono uniche come chi le sceglie e consentono un'ottima gestione del bagno, incontrando esigenze di ristrutturazione e di stili diverse.



SKILL A 120X80 BIANCO MORBIDO



SKILL A 120X80 PERLA



SKILL DUAL BLU BRILLANTE

## SKILL | FINITURE

### FINITURE STRUTTURA



Bianco lucido

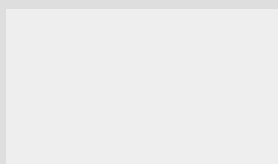

Bianco morbido

### FINITURA VETRI



Trasparente

### FINITURE FASCE E DETTAGLI



Blu brillante  
cod N0

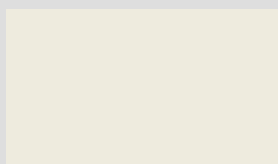

Grigio chiaro  
cod N1

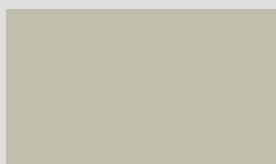

Tortora  
cod N2

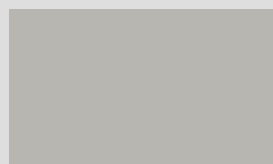

Perla  
cod N3

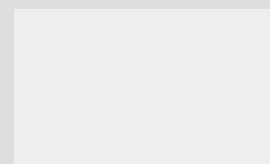

Bianco morbido  
cod U

## SKILL | FUNZIONI E DOTAZIONI (disponibili a seconda dell'allestimento)



Miscelatore meccanico o termostatico e doccia a mano con flessibile orientabile

Tettuccio con soffione doccia

Sistema di idromassaggio verticale

Cascata d'acqua

Ripiani d'appoggio

Bluetooth

Sedile reclinabile

Pannello di controllo elettronico soft-touch

Cromolight (versione hammam)  
Luce led (versione essential)

HAMMAM (Sauna di vapore + erogatore di vapore con dispenser di aromi)





SKILL



Immergersi in un bagno emozionale di luce con Chromolight integrata nel tettuccio

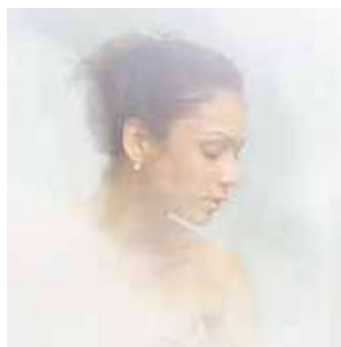

Avvolgere il corpo con una soffice nuvola di vapore e di aromi di olii essenziali



Comando capacitivo a sfioro semplice e sicuro



Sedile ripiegabile per adattarsi a tutti gli utilizzi della cabina.



# SKILL

# SKILL DUAL

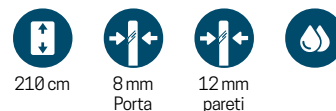

**CABINA MULTIFUNZIONE: DOPPIA POSTAZIONE E SAUNA DI VAPORE, APERTURA 2 ANTE SCORREVOLI E 2 FISSE IN LINEA**

Design Marco Pellici

Misure				Codice	Installazione		Miscelatore	Vetro	Scelta finitura									
Dimensioni	Piatta doccia (cm)	Altezza totale (cm)	Entrata (cm)		D	S	T	1	Finitura bianco lucido				Finitura bianco morbido					
					Destra	Sinistra	Termostatico	Trasparente	AN0	AN1	AN2	AN3	UN0	UN1	UN2	UN3	UU	
	<b>C</b>		*						Blu brillante	Grigio chiaro	Tortora	Perla	Blu brillante	Grigio chiaro	Tortora	Perla	Bianco morbido	
<b>HAMMAM CENTRO PARETE</b>																		
					<b>D</b>	<b>S</b>	<b>T5-</b>	<b>1</b>	<b>AN0</b>	<b>AN1</b>	<b>AN2</b>	<b>AN3</b>	<b>UN0</b>	<b>UN1</b>	<b>UN2</b>	<b>UN3</b>	<b>UU</b>	
160 x 97	H 4,5	211	62	<b>SKI2A160</b>	-	-			12.527 €	12.527 €	12.527 €	12.527 €	12.874 €	12.874 €	12.874 €	12.874 €	12.874 €	
160 x 97	H 12,5	219	62	<b>SKI2A169</b>	-	-												
<b>HAMMAM INSTALLAZIONE AD ANGOLO</b>																		
					<b>D</b>	<b>S</b>	<b>T5-</b>	<b>1</b>	<b>AN0</b>	<b>AN1</b>	<b>AN2</b>	<b>AN3</b>	<b>UN0</b>	<b>UN1</b>	<b>UN2</b>	<b>UN3</b>	<b>UU</b>	
160 x 97	H 4,5	211	62	<b>SKI2A160</b>					12.527 €	12.527 €	12.527 €	12.527 €	12.874 €	12.874 €	12.874 €	12.874 €	12.874 €	
160 x 97	H 12,5	219	62	<b>SKI2A169</b>														





SKILL

SKILL DUAL PERLA

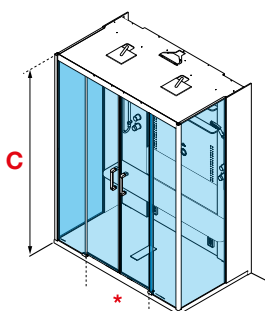

**S** Sinistra

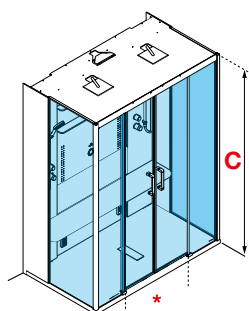

**D** Destra

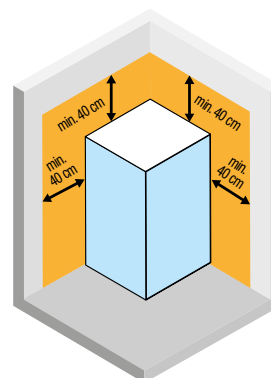
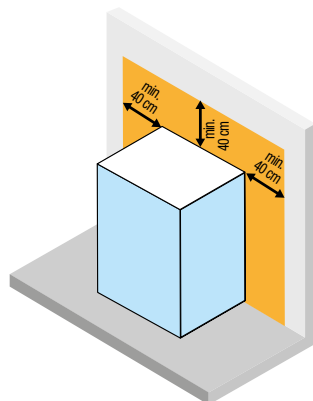

**GARANTIRE IL RICAMBIO  
D'ARIA E LO SPAZIO  
PER LA MANUTENZIONE  
DELLA SAUNA  
(VEDI MANUALE DI  
INSTALLAZIONE)**

# SKILL A

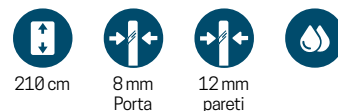

## CABINA MULTIFUNZIONE ASIMMETRICA, APERTURA 2 ANTE SCORREVOLI E 2 FISSE

Design Marco Pellici

Misure				Codice	Installazione		Miscelatore		Vetro	Scelta finitura								
Dimensioni	Piatto doccia (cm)	Altezza totale (cm)	Entrata (cm)		D	S	M	T		Finitura bianco lucido				Finitura bianco morbido				
				AN0					AN1	AN2	AN3	UN0	UN1	UN2	UN3	UU		
									1	Blu brillante	Grigio chiaro	Tortora	Perla	Blu brillante	Grigio chiaro	Tortora	Perla	Bianco morbido

ESSENTIAL																		
					D	S	M1F-	T1F-	1	AN0	AN1	AN2	AN3	UN0	UN1	UN2	UN3	UU
100x80	H 4,5	209,5	44	<b>SKIA100</b>						5.938 €	5.938 €	5.938 €	5.938 €	6.247 €	6.247 €	6.247 €	6.247 €	6.247 €
100x80	H 12,5	217,5	44	<b>SKIA109</b>														
120x80	H 4,5	209,5	51	<b>SKIA120</b>						6.198 €	6.198 €	6.198 €	6.198 €	6.507 €	6.507 €	6.507 €	6.507 €	6.507 €
120x80	H 12,5	217,5	51	<b>SKIA129</b>														
120x90	H 4,5	209,5	54	<b>SKIA290</b>						6.532 €	6.532 €	6.532 €	6.532 €	6.840 €	6.840 €	6.840 €	6.840 €	6.840 €
120x90	H 12,5	217,5	54	<b>SKIA299</b>														
120x100	H 4,5	209,5	58	<b>SKIA210</b>						6.878 €	6.878 €	6.878 €	6.878 €	7.187 €	7.187 €	7.187 €	7.187 €	7.187 €
120x100	H 12,5	217,5	58	<b>SKIA219</b>														

HAMMAM																		
					D	S	M5-	T5-	1	AN0	AN1	AN2	AN3	UN0	UN1	UN2	UN3	UU
100x80	H 4,5	211	44	<b>SKIA100</b>						7.138 €	7.138 €	7.138 €	7.138 €	7.447 €	7.447 €	7.447 €	7.447 €	7.447 €
100x80	H 12,5	219	44	<b>SKIA109</b>														
120x80	H 4,5	211	51	<b>SKIA120</b>						7.398 €	7.398 €	7.398 €	7.398 €	7.707 €	7.707 €	7.707 €	7.707 €	7.707 €
120x80	H 12,5	219	51	<b>SKIA129</b>														
120x90	H 4,5	211	54	<b>SKIA290</b>						7.730 €	7.730 €	7.730 €	7.730 €	8.039 €	8.039 €	8.039 €	8.039 €	8.039 €
120x90	H 12,5	219	54	<b>SKIA299</b>														
120x100	H 4,5	211	58	<b>SKIA210</b>						8.078 €	8.078 €	8.078 €	8.078 €	8.387 €	8.387 €	8.387 €	8.387 €	8.387 €
120x100	H 12,5	219	58	<b>SKIA219</b>														





SKILL

SKILL A PERLA

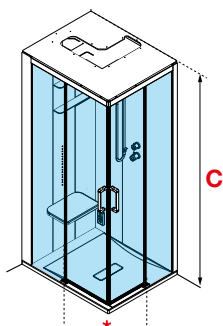

**S** Sinistra

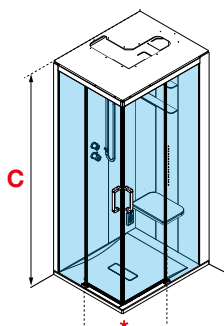

**D** Destra

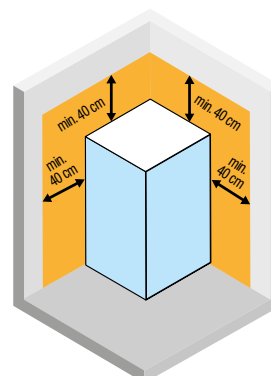

**GARANTIRE IL RICAMBIO  
D'ARIA E LO SPAZIO  
PER LA MANUTENZIONE  
DELLA SAUNA  
(VEDI MANUALE DI  
INSTALLAZIONE)**

# SKILL 2P

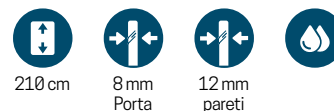

**CABINA MULTIFUNZIONE ASIMMETRICA,  
APERTURA 1 ANTA SCORREVOLE E 1 FISSA IN LINEA CON 1 FISSO LATERALE**  
Design Marco Pellici

Misure				Codice	Installazione		Miscelatore		Vetro	Scelta finitura									
Dimensioni	Piatto doccia (cm)	Altezza totale (cm)	Entrata (cm)		D	S	M	T		Finitura bianco lucido				Finitura bianco morbido					
									1	AN0	AN1	AN2	AN3	UN0	UN1	UN2	UN3	UU	

ESSENTIAL																		
					D	S	M1F-	T1F-	1	AN0	AN1	AN2	AN3	UN0	UN1	UN2	UN3	UU
140x80	H 4,5	209,5	55	<b>SKI2P140</b>						6.883 €	6.883 €	6.883 €	6.883 €	7.192 €	7.192 €	7.192 €	7.192 €	7.192 €
140x80	H 12,5	217,5	55	<b>SKI2P149</b>				+ 135 €										

HAMMAM																		
					D	S	M5-	T5-	1	AN0	AN1	AN2	AN3	UN0	UN1	UN2	UN3	UU
140x80	H 4,5	209,5	55	<b>SKI2P140</b>						8.080 €	8.080 €	8.080 €	8.080 €	8.389 €	8.389 €	8.389 €	8.389 €	8.389 €
140x80	H 12,5	217,5	55	<b>SKI2P149</b>				+ 135 €										



SKILL

SKILL 2P PERLA

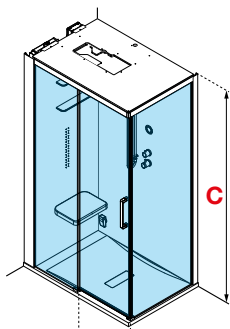

**S** Sinistra

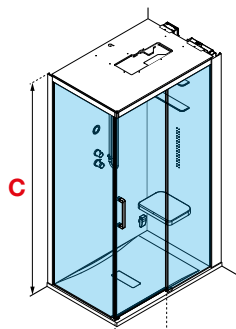

**D** Destra

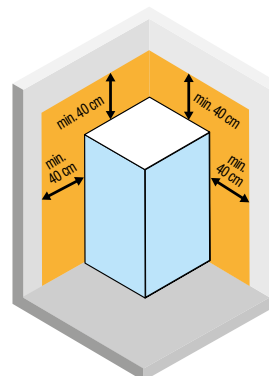

**GARANTIRE IL RICAMBIO  
D'ARIA E LO SPAZIO  
PER LA MANUTENZIONE  
DELLA SAUNA  
(VEDI MANUALE DI  
INSTALLAZIONE)**

WHITE



BLACK



SILVER



## GLAX 1 | FINITURE

	PROFILI	MANIGLIA	COLONNA	PORTASAPONE	PARETI DI FONDO	PIATTO	TETTUCCIO *	SEDILE *
<b>WHITE</b>	Bianco opaco	Bianco opaco	Bianco opaco	Bianco opaco	Bianco	Bianco lucido	Bianco opaco	Bianco
<b>BLACK</b>	Nero opaco	Nero opaco	Nero opaco	Nero opaco	Bianco	Bianco lucido	Bianco opaco	Bianco
<b>SILVER</b>	Silver	Cromo	Silver	Cromo	Bianco	Bianco lucido	Bianco opaco	Bianco

\* disponibili a seconda dell' allestimento

## GLAX 1 | FUNZIONI E DOTAZIONI (disponibili a seconda dell'allestimento)

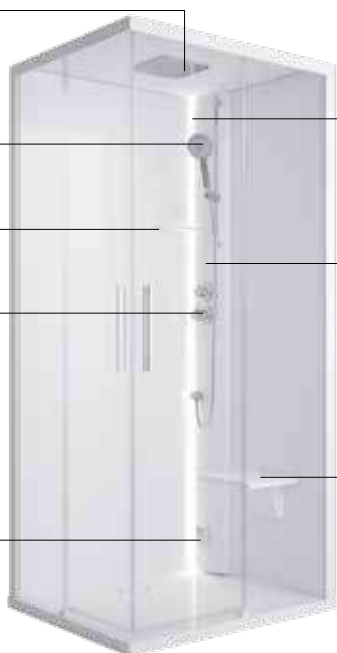

Miscelatore meccanico o termostatico e doccia a mano con flessibile orientabile

Tettuccio con soffione doccia

Ripiani d'appoggio

Bluetooth

Sedile reclinabile

Pannello di controllo elettronico

Cromolight (versione sauna basic)  
Luce led (versione standard+tettuccio+light)

HAMMAM (Sauna di vapore + erogatore di vapore con dispenser di aromi)





GLAX 1 2P WHITE

GLAX 1



Design pulito e contemporaneo con grandi superfici vetrate e pochi profili. Il tettuccio in vetro è integrato nello spessore dei profili



Sedile reclinabile



La luce led bianca o con programmazione Cromolight dei colori è elegantemente integrata nella colonna.



Esperienza emozionale e sensoriale con la sauna di vapore con il diffusore di aromi. Solo per versione sauna basic.

# GLAX 1



# GLAX 1 2P



205 cm 6 mm Porta 5 mm pareti

## CABINA MULTIFUNZIONE ASIMMETRICA, APERTURA 1 ANTA SCORREVOLE E 1 FISSA IN LINEA CON 1 FISSO LATERALE

Design Marco Pellici

Misure				Codice	Installazione		Miscelatore		Vetro	Scelta finitura		
Dimensioni (cm)	Piatto doccia (cm)	Altezza totale (cm)	Entrata (cm)		D	S	M	T		1	UU	HH
		<b>C</b>	<b>*</b>		Destra	Sinistra	Meccanico	Termostatico	Trasparente	Bianco	Nero	Silver
<b>STANDARD</b>												
					D	S	M-	T-	1	UU	HH	BB
120 X 80	4,5	210	49	<b>G212P120</b>						2.602 €	2.872 €	2.872 €
120 X 80	11,5	217	49	<b>G212P129</b>	●	●		●	●			
140 X 80	4,5	210	60	<b>G212P140</b>						3.043 €	3.327 €	3.327 €
140 X 80	12,5	218	60	<b>G212P149</b>								
120 X 90	4,5	210	49	<b>G212P290</b>				+ 92 €		2.730 €	3.014 €	3.014 €
120 X 90	11,5	217	49	<b>G212P299</b>								
140 X 90	4,5	210	60	<b>G212P490</b>						3.180 €	3.464 €	3.464 €
140 X 90	12,5	218	60	<b>G212P499</b>								
<b>STANDARD + TETTUCCIO</b>												
					D	S	MF-	TF-	1	UU	HH	BB
120 X 80	4,5	217	49	<b>G212P120</b>						2.988 €	3.297 €	3.297 €
120 X 80	11,5	224	49	<b>G212P129</b>	●	●		●	●			
140 X 80	4,5	217	60	<b>G212P140</b>						3.429 €	3.752 €	3.752 €
140 X 80	12,5	225	60	<b>G212P149</b>								
120 X 90	4,5	217	49	<b>G212P290</b>				+ 92 €		3.117 €	3.439 €	3.439 €
120 X 90	11,5	224	49	<b>G212P299</b>								
140 X 90	4,5	217	60	<b>G212P490</b>						3.567 €	3.889 €	3.889 €
140 X 90	12,5	225	60	<b>G212P499</b>								
<b>STANDARD+TETTUCCIO+LIGHT</b>												
					D	S	MFL-	TFL-	1	UU	HH	BB
120 X 80	4,5	217	49	<b>G212P120</b>						3.374 €	3.722 €	3.722 €
120 X 80	11,5	224	49	<b>G212P129</b>								
140 X 80	4,5	217	60	<b>G212P140</b>						3.815 €	4.175 €	4.175 €
140 X 80	12,5	225	60	<b>G212P149</b>								
120 X 90	4,5	217	49	<b>G212P290</b>				+ 92 €		3.503 €	3.863 €	3.863 €
120 X 90	11,5	224	49	<b>G212P299</b>								
140 X 90	4,5	217	60	<b>G212P490</b>						3.953 €	4.313 €	4.313 €
140 X 90	12,5	225	60	<b>G212P499</b>								
<b>HAMMAM</b>												
					D	S	M5-	T5-	1	UU	HH	BB
120 X 80	4,5	217	49	<b>G212P120</b>						3.889 €	4.288 €	4.288 €
120 X 80	11,5	224	49	<b>G212P129</b>	●	●		●	●			
140 X 80	4,5	217	60	<b>G212P140</b>						4.330 €	4.743 €	4.743 €
140 X 80	12,5	225	60	<b>G212P149</b>								
120 X 90	4,5	217	49	<b>G212P290</b>				+ 92 €		4.018 €	4.430 €	4.430 €
120 X 90	11,5	224	49	<b>G212P299</b>								
140 X 90	4,5	217	60	<b>G212P490</b>						4.468 €	4.880 €	4.880 €
140 X 90	12,5	225	60	<b>G212P499</b>								





GLAX 1

GLAX 1 2P WHITE

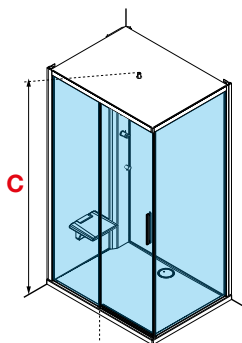

S Sinistra

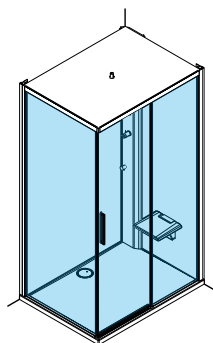

D Destra

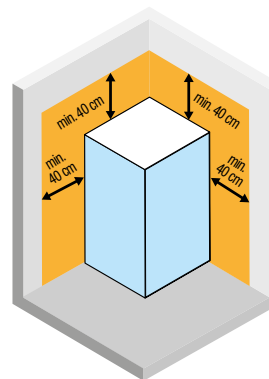

**GARANTIRE IL RICAMBIO  
D'ARIA E LO SPAZIO  
PER LA MANUTENZIONE  
DELLA SAUNA  
(VEDI MANUALE DI  
INSTALLAZIONE)**

## CABINA MULTIFUNZIONE, APERTURA 2 ANTE SCORREVOLI E 2 FISSE

Design Marco Pellici

Misure				Codice	Installazione		Miscelatore		Vetro	Scelta finitura		
Dimensioni (cm)	Piatto doccia (cm)	Altezza totale (cm)	Entrata (cm)		D	S	M	T		1	UU	HH
		<b>C</b>	*		Destra	Sinistra	Meccanico	Termostatico	Trasparente	Bianco	Nero	Silver
<b>STANDARD</b>												
					D	S	M-	T-	1	UU	HH	BB
80 X 80	4,5	210	40	<b>G21A80</b>						2.344 €	2.589 €	2.589 €
80 X 80	11,5	217	40	<b>G21A89</b>								
90 X 90	4,5	210	47	<b>G21A90</b>	-	-				2.409 €	2.659 €	2.659 €
90 X 90	11,5	217	47	<b>G21A99</b>								
100 X 100	4,5	210	54	<b>G21A100</b>						2.473 €	2.730 €	2.730 €
100 X 100	11,5	217	54	<b>G21A109</b>								
90 X 70	4,5	210	40	<b>G21A9070</b>				+ 92 €		2.344 €	2.589 €	2.589 €
90 X 70	11,5	217	40	<b>G21A9079</b>								
100 X 70	4,5	210	43,5	<b>G21A107</b>						2.409 €	2.659 €	2.659 €
100 X 70	11,5	217	43,5	<b>G21A197</b>	•	•		•	•			
100 X 80	4,5	210	47,5	<b>G21A108</b>						2.473 €	2.730 €	2.730 €
100 X 80	11,5	217	47,5	<b>G21A198</b>	•	•		•	•			
<b>STANDARD + TETTuccio</b>												
					D	S	MF-	TF-	1	UU	HH	BB
80 X 80	4,5	217	40	<b>G21A80</b>						2.730 €	3.014 €	3.014 €
80 X 80	11,5	224	40	<b>G21A89</b>								
90 X 90	4,5	217	47	<b>G21A90</b>	-	-				2.795 €	3.084 €	3.084 €
90 X 90	11,5	224	47	<b>G21A99</b>								
100 X 100	4,5	217	54	<b>G21A100</b>						2.859 €	3.155 €	3.155 €
100 X 100	11,5	224	54	<b>G21A109</b>								
90 X 70	4,5	217	40	<b>G21A9070</b>				+ 92 €		2.730 €	3.014 €	3.014 €
90 X 70	11,5	224	40	<b>G21A9079</b>								
100 X 70	4,5	217	43,5	<b>G21A107</b>						2.795 €	3.084 €	3.084 €
100 X 70	11,5	224	43,5	<b>G21A197</b>	•	•		•	•			
100 X 80	4,5	217	47,5	<b>G21A108</b>						2.859 €	3.155 €	3.155 €
100 X 80	11,5	224	47,5	<b>G21A198</b>	•	•		•	•			
<b>STANDARD+TETTuccio+LIGHT</b>												
					D	S	MFL-	TFL-	1	UU	HH	BB
80 X 80	4,5	217	40	<b>G21A80</b>						3.117 €	3.439 €	3.439 €
80 X 80	11,5	224	40	<b>G21A89</b>								
90 X 90	4,5	217	47	<b>G21A90</b>	-	-				3.182 €	3.509 €	3.509 €
90 X 90	11,5	224	47	<b>G21A99</b>								
100 X 100	4,5	217	54	<b>G21A100</b>						3.245 €	3.580 €	3.580 €
100 X 100	11,5	224	54	<b>G21A109</b>								
90 X 70	4,5	217	40	<b>G21A9070</b>				+ 92 €		3.117 €	3.439 €	3.439 €
90 X 70	11,5	224	40	<b>G21A9079</b>								
100 X 70	4,5	217	43,5	<b>G21A107</b>						3.182 €	3.509 €	3.509 €
100 X 70	11,5	224	43,5	<b>G21A197</b>								
100 X 80	4,5	217	47,5	<b>G21A108</b>						3.245 €	3.580 €	3.580 €
100 X 80	11,5	224	47,5	<b>G21A198</b>								
<b>HAMMAM</b>												
					D	S	M5-	T5-	1	UU	HH	BB
80 X 80	4,5	217	40	<b>G21A80</b>						3.632 €	4.005 €	4.005 €
80 X 80	11,5	224	40	<b>G21A89</b>								
90 X 90	4,5	217	47	<b>G21A90</b>	-	-				3.697 €	4.075 €	4.075 €
90 X 90	11,5	224	47	<b>G21A99</b>								
100 X 100	4,5	217	54	<b>G21A100</b>						3.760 €	4.147 €	4.147 €
100 X 100	11,5	224	54	<b>G21A109</b>								
90 X 70	4,5	217	40	<b>G21A9070</b>				+ 92 €		3.632 €	4.005 €	4.005 €
90 X 70	11,5	224	40	<b>G21A9079</b>								
100 X 70	4,5	217	43,5	<b>G21A107</b>						3.697 €	4.075 €	4.075 €
100 X 70	11,5	224	43,5	<b>G21A197</b>	•	•		•	•			
100 X 80	4,5	217	47,5	<b>G21A108</b>						3.760 €	4.147 €	4.147 €
100 X 80	11,5	224	47,5	<b>G21A198</b>	•	•		•	•			



GLAX 1

**GLAX 1 A SILVER**

80x80 | 90x90 | 100x100

90x70 | 100x70 | 100x80

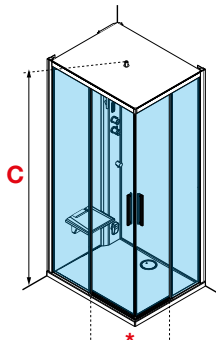
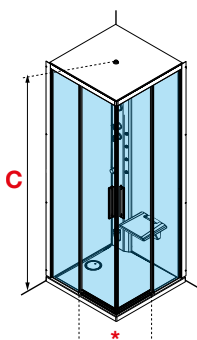

**S** Sinistra

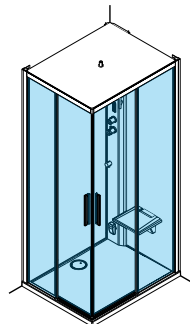

**D** Destra

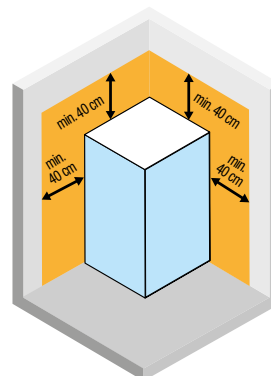

**GARANTIRE IL RICAMBIO  
D'ARIA E LO SPAZIO  
PER LA MANUTENZIONE  
DELLA SAUNA  
(VEDI MANUALE DI  
INSTALLAZIONE)**

# GLAX 1 G+F



205 cm 6 mm Porta 5 mm pareti

## CABINA MULTIFUNZIONE, APERTURA 1 ANTA BATTENTE CON FISSO LATERALE

Design Marco Pellici

Misure				Codice	Installazione		Miscelatore		Vetro	Scelta finitura		
Dimensioni (cm)	Piatto doccia (cm)	Altezza totale (cm)	Entrata (cm)		D	S	M	T	1	UU	HH	BB
		<b>C</b>	*		Destra	Sinistra	Meccanico	Termostatico	Trasparente	Bianco	Nero	Silver

STANDARD												
					D	S	M-	T-	1	UU	HH	BB
80 X 80	4,5	210	61	<b>G21GF80</b>								
80 X 80	11,5	217	61	<b>G21GF89</b>				+ 92 €		2.344 €	2.589 €	2.589 €
90 X 90	4,5	210	71	<b>G21GF90</b>						2.409 €	2.659 €	2.659 €
90 X 90	11,5	217	71	<b>G21GF99</b>								

STANDARD + TETTUCCIO												
					D	S	MF-	TF-	1	UU	HH	BB
80 X 80	4,5	217	61	<b>G21GF80</b>								
80 X 80	11,5	224	61	<b>G21GF89</b>				+ 92 €		2.730 €	3.014 €	3.014 €
90 X 90	4,5	217	71	<b>G21GF90</b>						2.795 €	3.084 €	3.084 €
90 X 90	11,5	224	71	<b>G21GF99</b>								

STANDARD+TETTUCCIO+LIGHT												
					D	S	MFL-	TFL-	1	UU	HH	BB
80 X 80	4,5	217	61	<b>G21GF80</b>								
80 X 80	11,5	224	61	<b>G21GF89</b>				+ 92 €		3.117 €	3.439 €	3.439 €
90 X 90	4,5	217	71	<b>G21GF90</b>						3.182 €	3.509 €	3.509 €
90 X 90	11,5	224	71	<b>G21GF99</b>								

HAMMAM												
					D	S	M5-	T5-	1	UU	HH	BB
80 X 80	4,5	217	61	<b>G21GF80</b>								
80 X 80	11,5	224	61	<b>G21GF89</b>				+ 92 €		3.632 €	4.005 €	4.005 €
90 X 90	4,5	217	71	<b>G21GF90</b>						3.697 €	4.075 €	4.075 €
90 X 90	11,5	224	71	<b>G21GF99</b>								



GLAX 1

GLAX 1 G BLACK

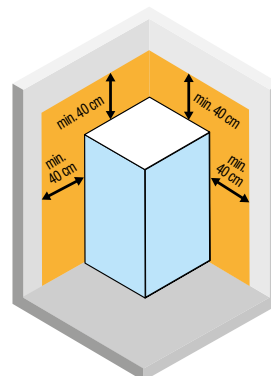
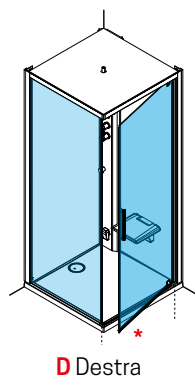
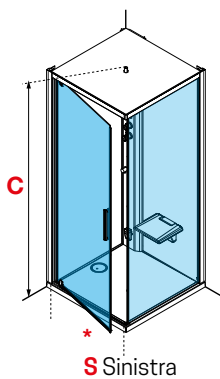

**GARANTIRE IL RICAMBIO  
D'ARIA E LO SPAZIO  
PER LA MANUTENZIONE  
DELLA SAUNA  
(VEDI MANUALE DI  
INSTALLAZIONE)**

# GLAX 1 R



205 cm 6 mm Porta 5 mm pareti

## CABINA MULTIFUNZIONE SEMICIRCOLARE, APERTURA 2 ANTE SCORREVOLI E 2 FISSE

Design Marco Pellici

Misure				Codice	Miscelatore		Vetro	Scelta finitura		
Dimensioni (cm)	Piatto doccia (cm)	Altezza totale (cm)	Entrata (cm)		M	T	1	UU	HH	BB
		<b>C</b>	*		Meccanico	Termostatico	Trasparente	Bianco	Nero	Silver

STANDARD										
					M-	T-	1	UU	HH	BB
90 X 90	4,5	210	49	<b>G21R90</b>		+ 92 €		2.859 €	3.155 €	3.155 €
90 X 90	11,5	217	49	<b>G21R99</b>						
100 X 100	4,5	210	49	<b>G21R100</b>				2.988 €	3.297 €	3.297 €
100 X 100	11,5	217	49	<b>G21R109</b>						

STANDARD + TETTuccio										
					MF-	TF-	1	UU	HH	BB
90 X 90	4,5	217	49	<b>G21R90</b>		+ 92 €		3.245 €	3.580 €	3.580 €
90 X 90	11,5	224	49	<b>G21R99</b>						
100 X 100	4,5	217	49	<b>G21R100</b>				3.374 €	3.722 €	3.722 €
100 X 100	11,5	224	49	<b>G21R109</b>						

STANDARD+TETTuccio+LIGHT										
					MFL-	TFL-	1	UU	HH	BB
90 X 90	4,5	217	49	<b>G21R90</b>		+ 92 €		3.632 €	4.005 €	4.005 €
90 X 90	11,5	224	49	<b>G21R99</b>						
100 X 100	4,5	217	49	<b>G21R100</b>				3.760 €	4.147 €	4.147 €
100 X 100	11,5	224	49	<b>G21R109</b>						

HAMMAM										
					M5-	T5-	1	UU	HH	BB
90 X 90	4,5	217	49	<b>G21R90</b>		+ 92 €		4.147 €	4.572 €	4.572 €
90 X 90	11,5	224	49	<b>G21R99</b>						
100 X 100	4,5	217	49	<b>G21R100</b>				4.275 €	4.713 €	4.713 €
100 X 100	11,5	224	49	<b>G21R109</b>						





GLAX 1

GLAX 1 R BLACK

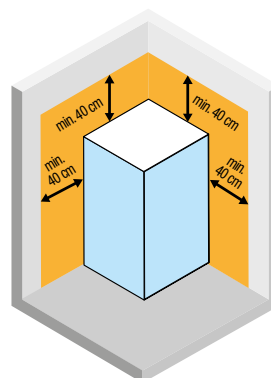
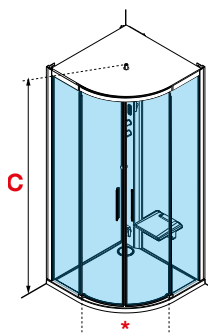

**GARANTIRE IL RICAMBIO  
D'ARIA E LO SPAZIO  
PER LA MANUTENZIONE  
DELLA SAUNA  
(VEDI MANUALE DI  
INSTALLAZIONE)**

# GLAX 1 A+F



205 cm



6 mm Porta 5 mm pareti



**CABINA MULTIFUNZIONE, APERTURA 2 ANTE SCORREVOLI E 2 FISSE + FISSO LATERALE**

Design Marco Pellici



GLAX 1 A+F SILVER

## OPTIONAL



**SEDILE IN ACRILICO  
OPALINO**

Codice Prezzo

**SED030PL 369 €**

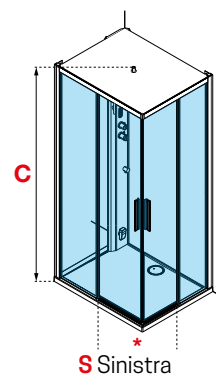

S Sinistra

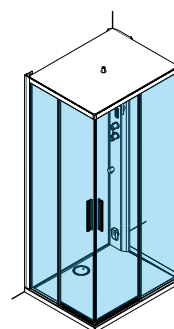

D Destra

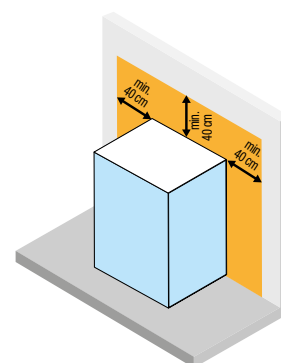

**GARANTIRE IL RICAMBIO  
D'ARIA E LO SPAZIO PER LA  
MANUTENZIONE DELLA SAUNA  
(VEDI MANUALE DI INSTALLAZIONE)**

Misure				Codice	Installazione		Miscelatore		Vetro	Scelta finitura		
Dimensioni (cm)	Piatto doccia (cm)	Altezza totale (cm)	Entrata (cm)		D	S	M	T		1	UU	HH
		<b>C</b>	*		Destra	Sinistra	Meccanico	Termostatico	Trasparente	Bianco	Nero	Silver
<b>STANDARD</b>												
					D	S	M-	T-	1	UU	HH	BB
100 X 80	4,5	210	47,5	<b>G21AF108</b>								
100 X 80	11,5	217	47,5	<b>G21AF198</b>				+ 92 €		2.597 €	2.868 €	2.868 €
<b>STANDARD + TETTUCCIO</b>												
					D	S	MF-	TF-	1	UU	HH	BB
100 X 80	4,5	217	47,5	<b>G21AF108</b>								
100 X 80	11,5	224	47,5	<b>G21AF198</b>				+ 92 €		3.003 €	3.314 €	3.314 €
<b>STANDARD+TETTUCCIO+LIGHT</b>												
					D	S	MFL-	TFL-	1	UU	HH	BB
100 X 80	4,5	217	47,5	<b>G21AF108</b>								
100 X 80	11,5	224	47,5	G21AF198						3.408 €	3.760 €	3.760 €
<b>HAMMAM</b>												
					D	S	M5-	T5-	1	UU	HH	BB
100 X 80	4,5	217	47,5	<b>G21AF108</b>								
100 X 80	11,5	224	47,5	<b>G21AF198</b>				+ 92 €		3.949 €	4.354 €	4.354 €

# GLAX 1 2P+2F



205 cm 6 mm Porta 5 mm pareti

**CABINA MULTIFUNZIONALE, APERTURA 1 ANTA SCORREVOLE E 1 FISSA IN LINEA + 2 FISSI LATERALI**

Design Marco Pellici



## OPTIONAL



**SEBILE IN ACRILICO OPALINO**

Codice Prezzo

**SED030PL 369 €**

Misure				Codice	Miscelatore		Vetro	Scelta finitura		
Dimensioni (cm)	Piatto doccia (cm)	Altezza totale (cm)	Entrata (cm)		M	T		1	UU	HH
		<b>C</b>	*		Meccanico	Termostatico	Trasparente	Bianco	Nero	Silver
<b>STANDARD</b>										
					<b>M-</b>	<b>T-</b>	<b>1</b>	<b>UU</b>	<b>HH</b>	<b>BB</b>
120 X 80	4,5	210	49	<b>G212PF120</b>				2.733 €	3.015 €	3.015 €
120 X 80	11,5	217	49	<b>G212PF129</b>		+ 92 €				
<b>STANDARD + TETTUCCIO</b>										
					<b>MF-</b>	<b>TF-</b>	<b>1</b>	<b>UU</b>	<b>HH</b>	<b>BB</b>
120 X 80	4,5	217	49	<b>G212PF120</b>				3.138 €	3.462 €	3.462 €
120 X 80	11,5	224	49	<b>G212PF129</b>		+ 92 €				
<b>STANDARD+TETTUCCIO+LIGHT</b>										
					<b>MFL-</b>	<b>TFL-</b>	<b>1</b>	<b>UU</b>	<b>HH</b>	<b>BB</b>
120 X 80	4,5	217	49	<b>G212PF120</b>				3.543 €	3.908 €	3.908 €
120 X 80	11,5	224	49	<b>G212PF129</b>		+ 92 €				
<b>HAMMAM</b>										
					<b>M5-</b>	<b>T5-</b>	<b>1</b>	<b>UU</b>	<b>HH</b>	<b>BB</b>
120 X 80	4,5	217	49	<b>G212PF120</b>				4.084 €	4.503 €	4.503 €
120 X 80	11,5	224	49	<b>G212PF129</b>		+ 92 €				

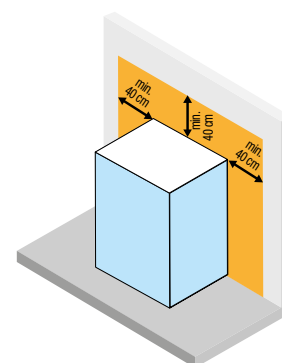
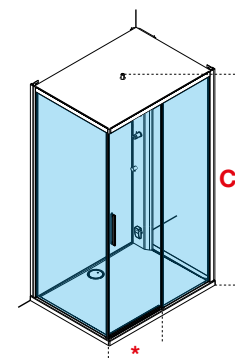

**GARANTIRE IL RICAMBIO D'ARIA E LO SPAZIO PER LA MANUTENZIONE DELLA SAUNA (VEDI MANUALE DI INSTALLAZIONE)**

GLAX 1



WHITE



TOTAL WHITE



BLACK



SILVER



CORDA

## GLAX 2 | FINITURE

	PROFILI	MANIGLIA	COLONNA + MENSOLA	PARETI FONDO	PIATTO	CUPOLINO *	SEDILE *
<b>WHITE</b>	Nero opaco	Nero opaco	Bianco opaco	Nero	Bianco opaco	Bianco opaco	Bianco
<b>TOTAL WHITE</b>	Bianco opaco	Bianco opaco	Bianco opaco	Bianco	Bianco opaco	Bianco opaco	Bianco
<b>BLACK</b>	Bianco opaco	Bianco opaco	Nero opaco	Bianco	Nero goffrato	Nero opaco	Bianco
<b>SILVER</b>	Silver	Cromo	Silver	Bianco	Bianco lucido	Bianco opaco	Bianco
<b>CORDA</b>	Bianco opaco	Bianco opaco	Corda	Bianco	Corda	Corda	Bianco

\* disponibili a seconda dell'allestimento

## GLAX 2 | FUNZIONI E DOTAZIONI (disponibili a seconda dell'allestimento)

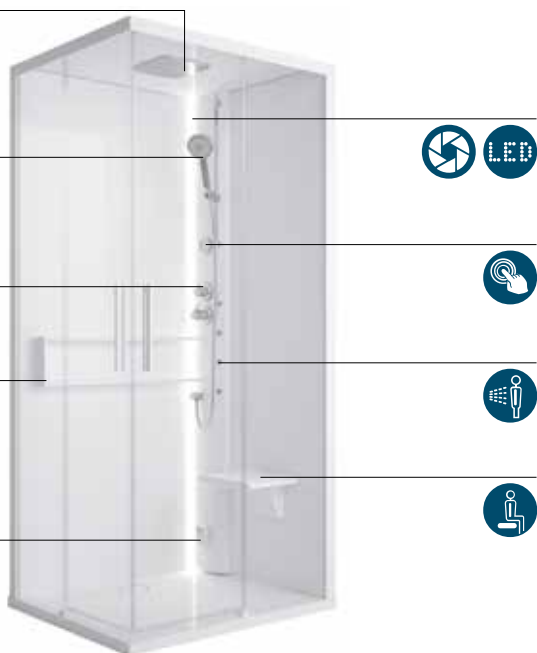

Miscelatore meccanico o termostatico e doccia a mano con flessibile orientabile

Tettuccio con soffione doccia

Sistema di idromassaggio verticale

Ripiani d'appoggio

Bluetooth

Sedile reclinabile

Pannello di controllo elettronico soft-touch

Cromolight (versione hammam+hydro plus)  
Luce led (versione hydro)

HAMMAM (Sauna di vapore + erogatore di vapore con dispenser di aromi)



GLAX 2 2P CORDA

GLAX 2



Design pulito e contemporaneo con grandi superfici vetrate e pochi profili. Il tettuccio in vetro è integrato nello spessore dei profili



La luce led bianca o con programmazione Cromolight dei colori è elegantemente integrata nella colonna.



Rilassante e tonificante idromassaggio verticale



Esperienza emozionale e sensoriale con la sauna di vapore con il diffusore di aromi.



# GLAX 2

# GLAX 2 2P



205 cm 6 mm Porta 5 mm pareti

## CABINA MULTIFUNZIONE ASIMMETRICA, APERTURA 1 ANTA SCORREVOLE E 1 FISSA IN LINEA CON 1 FISSO LATERALE

Design Marco Pellici

Misure				Codice	Installazione		Miscelatore		Vetro	Scelta finitura				
Dimensioni (cm)	Piatto doccia (cm)	Altezza totale (cm)	Entrata (cm)		D	S	M	T	1	UH	UU	HU	BB	TU
		<b>C</b>	*		Destra	Sinistra	Meccanico	Termostatico	Trasparente	Bianco	Total White	Nero	Silver	Corda

HYDRO														
					D	S	M1-	T1-	1	UH	UU	HU	BB	TU
120 X 80	4,5	217	49	<b>G222P120</b>						3.863 €	3.503 €	4.263 €	4.263 €	4.263 €
120 X 80	11,5	224	49	<b>G222P129</b>										
140 X 80	4,5	217	60	<b>G222P140</b>						4.318 €	3.944 €	4.729 €	4.729 €	4.729 €
140 X 80	12,5	225	60	<b>G222P149</b>										
120 X 90	4,5	217	49	<b>G222P290</b>						4.005 €	3.632 €	4.417 €	4.417 €	4.417 €
120 X 90	11,5	224	49	<b>G222P299</b>										
140 X 90	4,5	217	60	<b>G222P490</b>						4.455 €	4.082 €	4.867 €	4.867 €	4.867 €
140 X 90	12,5	225	60	<b>G222P499</b>										

HYDRO PLUS														
					D	S	M1L-	T1L-	1	UH	UU	HU	BB	TU
120 X 80	4,5	217	49	<b>G222P120</b>						4.288 €	3.889 €	4.727 €	4.727 €	4.727 €
120 X 80	11,5	224	49	<b>G222P129</b>										
140 X 80	4,5	217	60	<b>G222P140</b>						4.743 €	4.330 €	5.199 €	5.199 €	5.199 €
140 X 80	12,5	225	60	<b>G222P149</b>										
120 X 90	4,5	217	49	<b>G222P290</b>						4.430 €	4.018 €	4.887 €	4.887 €	4.887 €
120 X 90	11,5	224	49	<b>G222P299</b>										
140 X 90	4,5	217	60	<b>G222P490</b>						4.880 €	4.468 €	5.337 €	5.337 €	5.337 €
140 X 90	12,5	225	60	<b>G222P499</b>										

HAMMAM														
					D	S	M5-	T5-	1	UH	UU	HU	BB	TU
120 X 80	4,5	217	49	<b>G222P120</b>						4.997 €	4.533 €	5.505 €	5.505 €	5.505 €
120 X 80	11,5	224	49	<b>G222P129</b>	●	●		●	●					
140 X 80	4,5	217	60	<b>G222P140</b>						5.450 €	4.974 €	5.978 €	5.978 €	5.978 €
140 X 80	12,5	225	60	<b>G222P149</b>										
120 X 90	4,5	217	49	<b>G222P290</b>						5.138 €	4.662 €	5.665 €	5.665 €	5.665 €
120 X 90	11,5	224	49	<b>G222P299</b>										
140 X 90	4,5	217	60	<b>G222P490</b>						5.588 €	5.112 €	6.115 €	6.115 €	6.115 €
140 X 90	12,5	225	60	<b>G222P499</b>										





GLAX 2

GLAX 2 2P CORDA

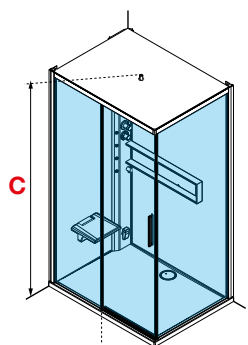

S Sinistra

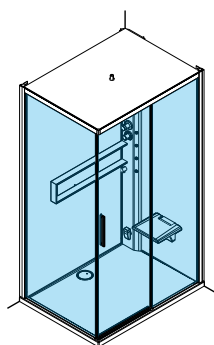

D Destra

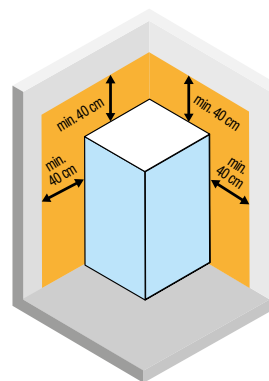

**GARANTIRE IL RICAMBIO  
D'ARIA E LO SPAZIO  
PER LA MANUTENZIONE  
DELLA SAUNA  
(VEDI MANUALE DI  
INSTALLAZIONE)**

## CABINA MULTIFUNZIONE, APERTURA 2 ANTE SCORREVOLI E 2 FISSE

Design Marco Pellici

Misure				Codice	Installazione		Miscelatore		Vetro	Scelta finitura				
Dimensioni (cm)	Piatto doccia (cm)	Altezza totale (cm)	Entrata (cm)		D	S	M	T	1	UH	UU	HU	BB	TU
		<b>C</b>	<b>*</b>		Destra	Sinistra	Meccanico	Termostatico	Trasparente	Bianco	Total White	Nero	Silver	Corda

HYDRO														
					D	S	M1-	T1-	1	UH	UU	HU	BB	TU
80 X 80	4,5	217	40	<b>G22A80</b>						3.580 €	3.245 €	3.947 €	3.947 €	3.947 €
80 X 80	11,5	224	40	<b>G22A89</b>										
90 X 90	4,5	217	47	<b>G22A90</b>	-	-				3.652 €	3.310 €	4.030 €	4.030 €	4.030 €
90 X 90	11,5	224	47	<b>G22A99</b>										
100 X 100	4,5	217	54	<b>G22A100</b>						3.722 €	3.374 €	4.108 €	4.108 €	4.108 €
100 X 100	11,5	224	54	<b>G22A109</b>										
90 X 70	4,5	217	40	<b>G22A9070</b>				+ 92 €		3.580 €	3.245 €	3.947 €	3.947 €	3.947 €
90 X 70	11,5	224	40	<b>G22A9079</b>										
100 X 70	4,5	217	43,5	<b>G22A107</b>						3.652 €	3.310 €	4.030 €	4.030 €	4.030 €
100 X 70	11,5	224	43,5	<b>G22A197</b>										
100 X 80	4,5	217	47,5	<b>G22A108</b>						3.722 €	3.374 €	4.108 €	4.108 €	4.108 €
100 X 80	11,5	224	47,5	<b>G22A198</b>										

HYDRO PLUS														
					D	S	M1L-	T1L-	1	UH	UU	HU	BB	TU
80 X 80	4,5	217	40	<b>G22A80</b>						4.005 €	3.632 €	4.417 €	4.417 €	4.417 €
80 X 80	11,5	224	40	<b>G22A89</b>										
90 X 90	4,5	217	47	<b>G22A90</b>	-	-				4.075 €	3.697 €	4.494 €	4.494 €	4.494 €
90 X 90	11,5	224	47	<b>G22A99</b>										
100 X 100	4,5	217	54	<b>G22A100</b>						4.147 €	3.760 €	4.572 €	4.572 €	4.572 €
100 X 100	11,5	224	54	<b>G22A109</b>										
90 X 70	4,5	217	40	<b>G22A9070</b>				+ 92 €		4.005 €	3.632 €	4.417 €	4.417 €	4.417 €
90 X 70	11,5	224	40	<b>G22A9079</b>										
100 X 70	4,5	217	43,5	<b>G22A107</b>						4.075 €	3.697 €	4.494 €	4.494 €	4.494 €
100 X 70	11,5	224	43,5	<b>G22A197</b>										
100 X 80	4,5	217	47,5	<b>G22A108</b>						4.147 €	3.760 €	4.572 €	4.572 €	4.572 €
100 X 80	11,5	224	47,5	<b>G22A198</b>										

HAMMAM														
					D	S	M5-	T5-	1	UH	UU	HU	BB	TU
80 X 80	4,5	217	40	<b>G22A80</b>						4.713 €	4.275 €	5.197 €	5.197 €	5.197 €
80 X 80	11,5	224	40	<b>G22A89</b>										
90 X 90	4,5	217	47	<b>G22A90</b>	-	-				4.784 €	4.340 €	5.273 €	5.273 €	5.273 €
90 X 90	11,5	224	47	<b>G22A99</b>										
100 X 100	4,5	217	54	<b>G22A100</b>						4.855 €	4.404 €	5.350 €	5.350 €	5.350 €
100 X 100	11,5	224	54	<b>G22A109</b>										
90 X 70	4,5	217	40	<b>G22A9070</b>				+ 92 €		4.713 €	4.275 €	5.197 €	5.197 €	5.197 €
90 X 70	11,5	224	40	<b>G22A9079</b>										
100 X 70	4,5	217	43,5	<b>G22A107</b>						4.784 €	4.340 €	5.273 €	5.273 €	5.273 €
100 X 70	11,5	224	43,5	<b>G22A197</b>										
100 X 80	4,5	217	47,5	<b>G22A108</b>						4.855 €	4.404 €	5.350 €	5.350 €	5.350 €
100 X 80	11,5	224	47,5	<b>G22A198</b>	●	●		●	●					







**GLAX 2 A TOTAL WHITE**

80x80 | 90x90 | 100x100

90x70 | 100x70 | 100x80

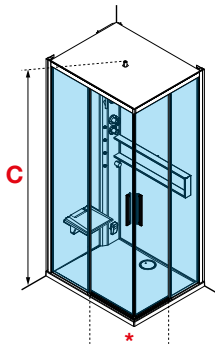
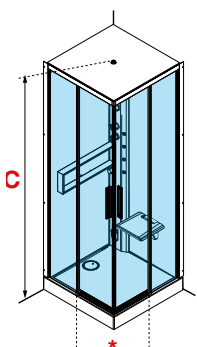

**S Sinistra**

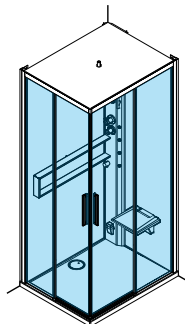

**D Destra**

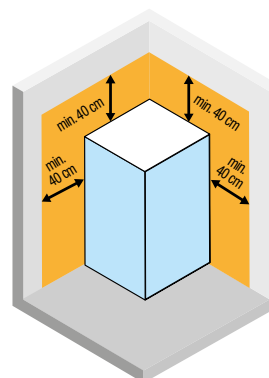

**GARANTIRE IL RICAMBIO  
D'ARIA E LO SPAZIO  
PER LA MANUTENZIONE  
DELLA SAUNA  
(VEDI MANUALE DI  
INSTALLAZIONE)**

# GLAX 2 G+F



## CABINA MULTIFUNZIONE, APERTURA 1 ANTA BATTENTE CON FISSO LATERALE

Design Marco Pellici

Misure				Codice	Installazione		Miscelatore		Vetro	Scelta finitura				
Dimensioni (cm)	Piatto doccia (cm)	Altezza totale (cm)	Entrata (cm)		D	S	M	T	1	UH	UU	HU	BB	TU
		<b>C</b>	*		Destra	Sinistra	Meccanico	Termostatico	Trasparente	Bianco	Total White	Nero	Silver	Corde
<b>HYDRO</b>														
					D	S	M1-	T1-	1	UH	UU	HU	BB	TU
80 X 80	4,5	217	61	<b>G22GF80</b>						3.580 €	3.245 €	3.947 €	3.947 €	3.947 €
80 X 80	11,5	224	61	<b>G22GF89</b>										
90 X 90	4,5	217	71	<b>G22GF90</b>					+ 92 €					
90 X 90	11,5	224	71	<b>G22GF99</b>						3.652 €	3.310 €	4.030 €	4.030 €	4.030 €
<b>HYDRO PLUS</b>														
					D	S	M1L-	T1L-	1	UH	UU	HU	BB	TU
80 X 80	4,5	217	61	<b>G22GF80</b>						4.005 €	3.632 €	4.417 €	4.417 €	4.417 €
80 X 80	11,5	224	61	<b>G22GF89</b>										
90 X 90	4,5	217	71	<b>G22GF90</b>					+ 92 €					
90 X 90	11,5	224	71	<b>G22GF99</b>						4.075 €	3.697 €	4.494 €	4.494 €	4.494 €
<b>HAMMAM</b>														
					D	S	M5-	T5-	1	UH	UU	HU	BB	TU
80 X 80	4,5	217	61	<b>G22GF80</b>						4.713 €	4.275 €	5.197 €	5.197 €	5.197 €
80 X 80	11,5	224	61	<b>G22GF89</b>										
90 X 90	4,5	217	71	<b>G22GF90</b>					+ 92 €					
90 X 90	11,5	224	71	<b>G22GF99</b>						4.784 €	4.340 €	5.273 €	5.273 €	5.273 €



GLAX 2

GLAX 2 G WHITE

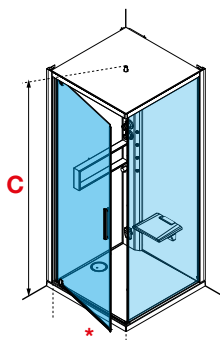

S Sinistra

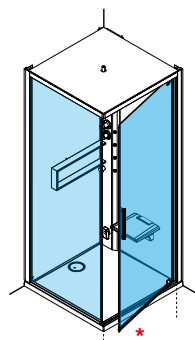

D Destra

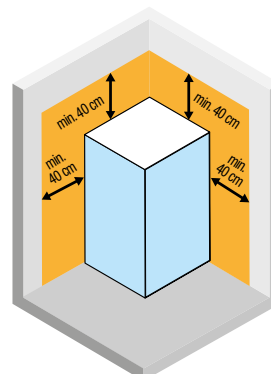

**GARANTIRE IL RICAMBIO  
D'ARIA E LO SPAZIO  
PER LA MANUTENZIONE  
DELLA SAUNA  
(VEDI MANUALE DI  
INSTALLAZIONE)**

# GLAX 2R



## CABINA MULTIFUNZIONE SEMICIRCOLARE, APERTURA 2 ANTE SCORREVOLI E 2 FISSE

Design Marco Pellici

Misure				Codice	Miscelatore		Vetro	Scelta finitura				
Dimensioni (cm)	Piatto doccia (cm)	Altezza totale (cm)	Entrata (cm)		M	T	1	UH	UU	HU	BB	TU
		<b>C</b>	*		Meccanico	Termostatico	Trasparente	Bianco	Total White	Nero	Silver	Corda
<b>HYDRO</b>												
					<b>M1-</b>	<b>T1-</b>	<b>1</b>	<b>UH</b>	<b>UU</b>	<b>HU</b>	<b>BB</b>	<b>TU</b>
90 X 90	4,5	217	49	<b>G22R90</b>				4.147 €	3.760 €	4.572 €	4.572 €	4.572 €
90 X 90	11,5	224	49	<b>G22R99</b>		+ 92 €						
100 X 100	4,5	217	49	<b>G22R100</b>				4.288 €	3.889 €	4.727 €	4.727 €	4.727 €
100 X 100	11,5	224	49	<b>G22R109</b>								
<b>HYDRO PLUS</b>												
					<b>M1L-</b>	<b>T1L-</b>	<b>1</b>	<b>UH</b>	<b>UU</b>	<b>HU</b>	<b>BB</b>	<b>TU</b>
90 X 90	4,5	217	49	<b>G22R90</b>				4.572 €	4.147 €	5.042 €	5.042 €	5.042 €
90 X 90	11,5	224	49	<b>G22R99</b>		+ 92 €						
100 X 100	4,5	217	49	<b>G22R100</b>				4.713 €	4.275 €	5.197 €	5.197 €	5.197 €
100 X 100	11,5	224	49	<b>G22R109</b>								
<b>HAMMAM</b>												
					<b>M5-</b>	<b>T5-</b>	<b>1</b>	<b>UH</b>	<b>UU</b>	<b>HU</b>	<b>BB</b>	<b>TU</b>
90 X 90	4,5	217	49	<b>G22R90</b>				5.279 €	4.790 €	5.820 €	5.820 €	5.820 €
90 X 90	11,5	224	49	<b>G22R99</b>		+ 92 €						
100 X 100	4,5	217	49	<b>G22R100</b>				5.422 €	4.919 €	5.975 €	5.975 €	5.975 €
100 X 100	11,5	224	49	<b>G22R109</b>								





GLAX 2

GLAX 2 R SILVER

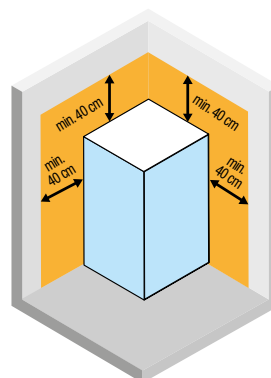
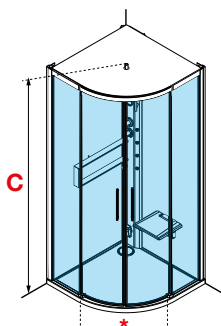

**GARANTIRE IL RICAMBIO  
D'ARIA E LO SPAZIO  
PER LA MANUTENZIONE  
DELLA SAUNA  
(VEDI MANUALE DI  
INSTALLAZIONE)**

# GLAX 2 A+F



205 cm 6 mm Porta 5 mm pareti

**CABINA MULTIFUNZIONE, APERTURA 2 ANTE SCORREVOLI E 2 FISSE + FISSO LATERALE**

Design Marco Pellici



GLAX 2 A+F CORDA

## OPTIONAL



**SEDILE IN ACRILICO OPALINO**

Codice Prezzo

**SED030PL 369 €**

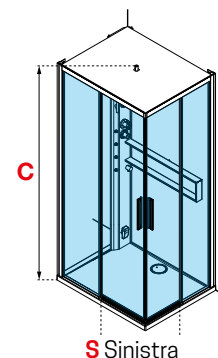

S Sinistra

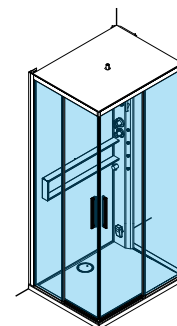

D Destra

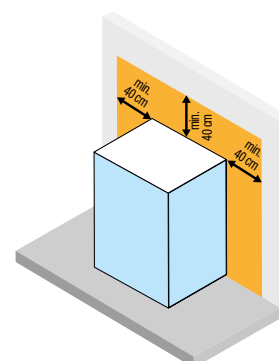

**GARANTIRE IL RICAMBIO D'ARIA E LO SPAZIO PER LA MANUTENZIONE DELLA SAUNA (VEDI MANUALE DI INSTALLAZIONE)**

Misure				Codice	Installazione		Miscelatore		Vetro	Scelta finitura				
Dimensioni (cm)	Piatto doccia (cm)	Altezza totale (cm)	Entrata (cm)		D	S	M	T		1	UH	UU	HU	BB
		<b>C</b>	*		Destra	Sinistra	Meccanico	Termostatico	Trasparente	Bianco	Total White	Nero	Silver	Corda

HYDRO														
					D	S	M1-	T1-	1	UH	UU	HU	BB	TU
100 X 80	4,5	217	47,5	<b>G22AF108</b>						3.908 €	3.543 €	4.314 €	4.314 €	4.314 €
100 X 80	11,5	224	47,5	<b>G22AF198</b>				+ 92 €						

HYDRO PLUS														
					D	S	M1L-	T1L-	1	UH	UU	HU	BB	TU
100 X 80	4,5	217	47,5	<b>G22AF108</b>						4.354 €	3.949 €	4.800 €	4.800 €	4.800 €
100 X 80	11,5	224	47,5	<b>G22AF198</b>				+ 92 €						

HAMMAM														
					D	S	M5-	T5-	1	UH	UU	HU	BB	TU
100 X 80	4,5	217	47,5	<b>G22AF108</b>						5.099 €	4.625 €	5.618 €	5.618 €	5.618 €
100 X 80	11,5	224	47,5	<b>G22AF198</b>				+ 92 €						

# GLAX 2 2P+2F



205 cm 6 mm Porta 5 mm pareti

**CABINA MULTIFUNZIONE, APERTURA 1 ANTA SCORREVOLE E 1 FISSA IN LINEA + 2 FISSI LATERALI**

Design Marco Pellici



## OPTIONAL



**SEBILE IN ACRILICO OPALINO**

Codice Prezzo

**SED030PL 369 €**

GLAX 2 2P+2F SILVER

Misure				Codice	Miscelatore		Vetro	Scelta finitura				
Dimensioni (cm)	Piatto doccia (cm)	Altezza totale (cm)	Entrata (cm)		M	T		1	UH	UU	HU	BB
		<b>C</b>	*		Meccanico	Termostatico	Trasparente	Bianco	Total White	Nero	Silver	Corda
<b>HYDRO</b>												
					<b>M1-</b>	<b>T1-</b>	<b>1</b>	<b>UH</b>	<b>UU</b>	<b>HU</b>	<b>BB</b>	<b>TU</b>
120 X 80	4,5	217	49	<b>G222PF120</b>		+ 92 €		4.057 €	3.679 €	4.477 €	4.477 €	4.477 €
120 X 80	11,5	224	49	<b>G222PF129</b>								

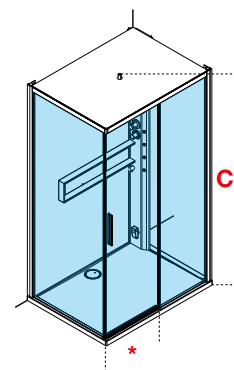

<b>HYDRO PLUS</b>												
					<b>M1L-</b>	<b>T1L-</b>	<b>1</b>	<b>UH</b>	<b>UU</b>	<b>HU</b>	<b>BB</b>	<b>TU</b>
120 X 80	4,5	217	49	<b>G222PF120</b>		+ 92 €		4.503 €	4.084 €	4.964 €	4.964 €	4.964 €
120 X 80	11,5	224	49	<b>G222PF129</b>								

<b>HAMMAM</b>												
					<b>M5-</b>	<b>T5-</b>	<b>1</b>	<b>UH</b>	<b>UU</b>	<b>HU</b>	<b>BB</b>	<b>TU</b>
120 X 80	4,5	217	49	<b>G222PF120</b>		+ 92 €		5.247 €	4.760 €	5.782 €	5.782 €	5.782 €
120 X 80	11,5	224	49	<b>G222PF129</b>								

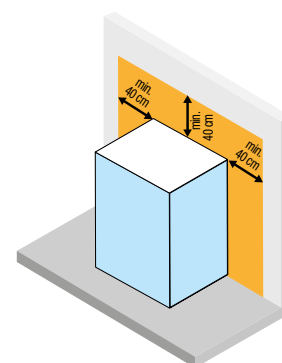

**GARANTIRE IL RICAMBIO D'ARIA E LO SPAZIO PER LA MANUTENZIONE DELLA SAUNA (VEDI MANUALE DI INSTALLAZIONE)**

Costruzione del codice **Codice** + **Installazione** + **Miscelatore** + **Vetro** + **Finitura** = Codice prodotto finale



CRYSTAL A CROMO/BIANCO



CRYSTAL 2P CROMO/BIANCO



CRYSTAL A CROMO/NERO

## CRYSTAL | FINITURE

### FINITURE STRUTTURA



Silver  
cod B



Cromo  
cod K

### FINITURE PANNELLI DI FONDO

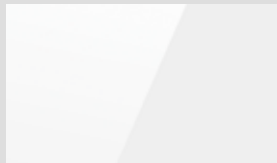

Bianco  
cod A



Nero  
cod H

### FINITURA VETRI



Trasparente  
spessore 6 mm

## CRYSTAL | FUNZIONI E DOTAZIONI (disponibili a seconda dell'allestimento)



-   **Miscelatore meccanico o termostatico e doccia a mano con flessibile orientabile**
-   **Tettuccio con soffione doccia**
-  **Sistema di idromassaggio verticale**
-  **Ripiani d'appoggio**
-  **Sedile reclinabile**
-  **HAMMAM (Sauna di vapore + erogatore di vapore con dispenser di aromi)**





CRYSTAL

CRYSTAL 2P CROMO/BIANCO



Soffione di grandi dimensioni

- 1 per cabina con tettuccio
- 2 per cabina senza tettuccio



Ripiani portaoggetti in vetro



Pannelli di fondo in vetro antigoccia



Sedile reclinabile



# CRYSTAL

# CRYSTAL 2P

**CABINA MULTIFUNZIONE ASIMMETRICA,  
APERTURA 1 ANTA SCORREVOLE E 1 FISSA IN LINEA CON 1 FISSO LATERALE**



210 cm  
con  
tettuccio



208 cm  
senza  
tettuccio



6 mm  
Porta



5 mm  
pareti



Misure				Codice	Installazione		Miscelatore		Idromas- saggio	Vetro	Scelta finitura		Pannello di fondo	
Dimensioni (cm)	Piatto doccia (cm)	Altezza totale (cm)	Entrata (cm)		D	S	M	T		1	B	K	A	H
		<b>C</b>	*		Destra	Sinistra	Mecca- nico	Termosta- tico		Trasparente	Silver	Cromo	Bianco	Nero

## STANDARD



					D	S	M-	T-		1	B	K	A	H
120 X 80	8	221	48	<b>HC22P120</b>										
120 X 80	15	228	48	<b>HC22P129</b>				+ 89 €	-				2.813 €	2.813 €

## IDROMASSAGGIO



					D	S	M	T	1-	1	B	K	A	H
120 X 80	8	221	48	<b>HC22P120</b>										
120 X 80	15	228	48	<b>HC22P129</b>				+ 89 €					2.980 €	2.980 €

## IDROMASSAGGIO CON TETTUCCIO



					D	S	M	T	1F-	1	B	K	A	H
120 X 80	8	222	48	<b>HC22P120</b>										
120 X 80	15	229	48	<b>HC22P129</b>				+ 89 €					3.465 €	3.465 €

## HAMMAM



					D	S	M	T	1N-	1	B	K	A	H
120 X 80	8	228	48	<b>HC22P120</b>										
120 X 80	15	235	48	<b>HC22P129</b>				+ 89 €					3.887 €	3.887 €



CRYSTAL

CRYSTAL 2P CROMO/NERO

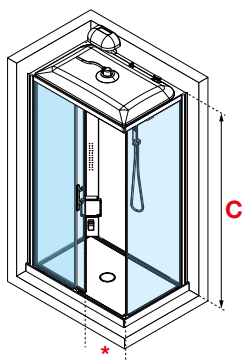

**S** Sinistra

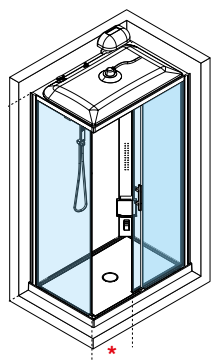

**D** Destra

# CRYSTAL A



## BOX DOCCIA AD ANGOLO APERTURA 2 ANTE SCORREVOLI E 2 FISSE

Misure				Codice	Installazione		Miscelatore		Idromassaggio	Vetro	Scelta finitura			Pannello di fondo	
Dimensioni (cm)	Piatto doccia (cm)	Altezza totale (cm)	Entrata (cm)		D	S	M	T		1	B	K	A	H	
		<b>C</b>	*		Destra	Sinistra	Meccanico	Termostatico		Trasparente	Silver	Cromo	Bianco	Nero	

### STANDARD

				Codice	D	S	M-	T-		1	B	K	A	H
80 X 80	8	221	40	<b>HC2A80</b>									2.473 €	2.473 €
80 X 80	15	228	40	<b>HC2A89</b>	-	-							2.758 €	2.758 €
90 X 90	8	221	47	<b>HC2A90</b>									2.558 €	2.558 €
90 X 90	15	228	47	<b>HC2A99</b>									2.643 €	2.643 €
90 X 70	8	221	40	<b>HC2A7090</b>				+ 89 €					2.740 €	2.740 €
90 X 70	15	228	40	<b>HC2A7099</b>										
100 X 70	8	221	44	<b>HC2A107</b>										
100 X 70	15	228	44	<b>HC2A197</b>										
100 X 80	8	221	47	<b>HC2A100</b>										
100 X 80	15	228	47	<b>HC2A109</b>										

### IDROMASSAGGIO

				Codice	D	S	M	T	1-	1	B	K	A	H
80 X 80	8	221	40	<b>HC2A80</b>									2.640 €	2.640 €
80 X 80	15	228	40	<b>HC2A89</b>	-	-							2.924 €	2.924 €
90 X 90	8	221	47	<b>HC2A90</b>									2.724 €	2.724 €
90 X 90	15	228	47	<b>HC2A99</b>									2.809 €	2.809 €
90 X 70	8	221	40	<b>HC2A7090</b>				+ 89 €					2.908 €	2.908 €
90 X 70	15	228	40	<b>HC2A7099</b>										
100 X 70	8	221	44	<b>HC2A107</b>										
100 X 70	15	228	44	<b>HC2A197</b>										
100 X 80	8	221	47	<b>HC2A100</b>										
100 X 80	15	228	47	<b>HC2A109</b>										

### IDROMASSAGGIO CON TETTUCCIO

				Codice	D	S	M	T	1F-	1	B	K	A	H
80 X 80	8	222	40	<b>HC2A80</b>									3.127 €	3.127 €
80 X 80	15	229	40	<b>HC2A89</b>	-	-							3.410 €	3.410 €
90 X 90	8	222	47	<b>HC2A90</b>									3.210 €	3.210 €
90 X 90	15	229	47	<b>HC2A99</b>									3.295 €	3.295 €
90 X 70	8	222	40	<b>HC2A7090</b>				+ 89 €					3.395 €	3.395 €
90 X 70	15	229	40	<b>HC2A7099</b>										
100 X 70	8	222	44	<b>HC2A107</b>										
100 X 70	15	229	44	<b>HC2A197</b>										
100 X 80	8	222	47	<b>HC2A100</b>										
100 X 80	15	229	47	<b>HC2A109</b>										

### HAMMAM

				Codice	D	S	M	T	1N-	1	B	K	A	H
80 X 80	8	228	40	<b>HC2A80</b>									3.547 €	3.547 €
80 X 80	15	235	40	<b>HC2A89</b>	-	-							3.830 €	3.830 €
90 X 90	8	228	47	<b>HC2A90</b>									3.630 €	3.630 €
90 X 90	15	235	47	<b>HC2A99</b>									3.715 €	3.715 €
90 X 70	8	228	40	<b>HC2A7090</b>				+ 89 €					3.814 €	3.814 €
90 X 70	15	235	40	<b>HC2A7099</b>										
100 X 70	8	228	44	<b>HC2A107</b>										
100 X 70	15	235	44	<b>HC2A197</b>										
100 X 80	8	228	47	<b>HC2A100</b>										
100 X 80	15	235	47	<b>HC2A109</b>										



CRYSTAL

CRYSTAL A CROMO/BIANCO

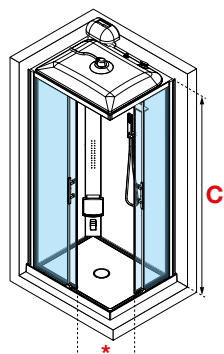
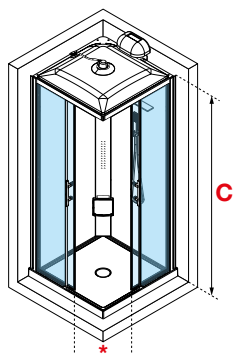

**S** Sinistra

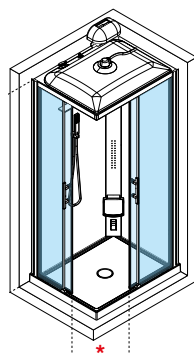

**D** Destra

# CRYSTAL G

CABINA MULTIFUNZIONE, APERTURA 1 ANTA BATTENTE CON FISSO LATERALE



Misure				Codice	Miscelatore		Idromassaggio	Vetro	Scelta finitura		Pannello di fondo	
Dimensioni (cm)	Piatto doccia (cm)	Altezza totale (cm)	Entrata (cm)		M	T		1	B	K	A	H
		<b>C</b>	*		Meccanico	Termostatico		Trasparente	Silver	Cromo	Bianco	Nero

## STANDARD

					M-	T-		1	B	K	A	H
90 X 90	8	221	69	<b>HC2G90</b>		+ 89 €	-				2.758 €	2.758 €
90 X 90	15	228	69	<b>HC2G99</b>								

## IDROMASSAGGIO

					M	T	1-	1	B	K	A	H
90 X 90	8	221	69	<b>HC2G90</b>		+ 89 €					2.924 €	2.924 €
90 X 90	15	228	69	<b>HC2G99</b>								

## IDROMASSAGGIO CON TETTuccio

					M	T	1F-	1	B	K	A	H
90 X 90	8	222	69	<b>HC2G90</b>		+ 89 €					3.410 €	3.410 €
90 X 90	15	229	69	<b>HC2G99</b>								

## HAMMAM

					M	T	1N-	1	B	K	A	H
90 X 90	8	228	69	<b>HC2G90</b>		+ 89 €					3.830 €	3.830 €
90 X 90	15	235	69	<b>HC2G99</b>								



CRYSTAL

CRYSTAL G CROMO/BIANCO

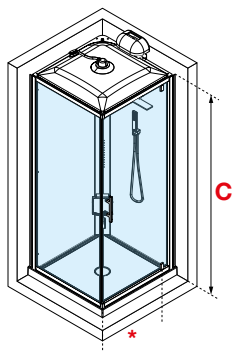



EON 2P HAMMAM BIANCO

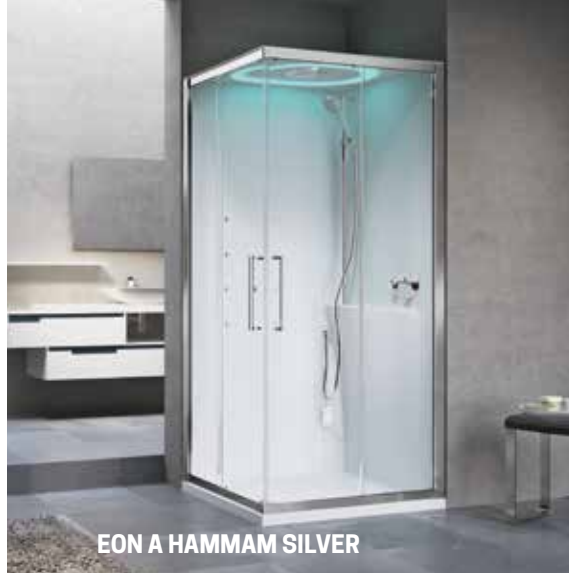

EON A HAMMAM SILVER



EON G HAMMAM CROMO

## EON | FINITURE

### FINITURE STRUTTURA



Bianco  
cod A



Silver  
cod B



Cromo  
cod K

### FINITURE PANNELLI DI FONDO



Bianco lucido  
cod A

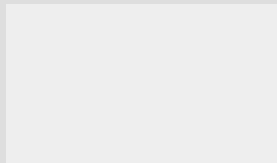

Bianco morbido  
cod U

### FINITURA VETRI



Trasparente  
spessore 6 mm

## EON | FUNZIONI E DOTAZIONI (disponibili a seconda dell'allestimento)



- Miselatore meccanico o termostatico e doccia a mano con flessibile orientabile
- Tettuccio con soffione doccia Ø 20 cm
- Sistema di idromassaggio verticale 8 jet
- Ripiano portaoggetti
- Bluetooth
- Telecomando
- Cromolight (versione hammam)  
Luce led (versione standard e idromassaggio con tettuccio)
- HAMMAM (Sauna di vapore + erogatore di vapore con dispenser di aromi)





EON 2P HAMMAM CROMO

EON



Rubinetteria meccanica o termostatica



Ripiano d'appoggio integrato



Sistema di idromassaggio verticale a nebulizzazione



Telecomando per gestire le funzioni della cabina (solo per versione Hammam)



# EON

## CABINA MULTIFUNZIONALE ASIMMETRICA, APERTURA 1 ANTA SCORREVOLE E 1 FISSA IN LINEA CON 1 FISSO LATERALE

Misure				Codice	Installazione		Miscelatore		Idromassaggio	Vetro	Scelta finitura					
Dimensioni (cm)	Piatto doccia (cm)	Altezza totale (cm)	Entrata (cm)		D	S	M	T			Pannello bianco lucido			Pannello bianco opaco		
				AA					AB	AK	UA	UB	UK			
										1	Bianco	Silver	Cromo	Bianco	Silver	Cromo

### STANDARD SENZA TETTuccio

					D	S	M-	T-		1	AA	AB	AK	UA	UB	UK
120x80	4,5	209,5	47	<b>EON2P120</b>							2.322 €	2.322 €	2.428 €	2.630 €	2.630 €	2.737 €
120x80	11,5	216,5	47	<b>EON2P129</b>				+ 83 €								
120x90	4,5	209,5	47	<b>EON2P290</b>							2.418 €	2.418 €	2.524 €	2.727 €	2.727 €	2.833 €
120x90	11,5	216,5	47	<b>EON2P299</b>												

### STANDARD CON TETTuccio (PLAFONIERA LUMINOSA CON INTERRUOTORE)

					D	S	M	T	T-	1	AA	AB	AK	UA	UB	UK
120x80	4,5	214	47	<b>EON2P120</b>							2.788 €	2.788 €	2.894 €	3.098 €	3.098 €	3.203 €
120x80	11,5	221	47	<b>EON2P129</b>				+ 83 €								
120x90	4,5	214	47	<b>EON2P290</b>							2.884 €	2.884 €	2.990 €	3.193 €	3.193 €	3.299 €
120x90	11,5	221	47	<b>EON2P299</b>												

### IDROMASSAGGIO SENZA TETTuccio

					D	S	M	T	1-	1	AA	AB	AK	UA	UB	UK
120x80	4,5	209,5	47	<b>EON2P120</b>							2.624 €	2.624 €	2.730 €	2.933 €	2.933 €	3.039 €
120x80	11,5	216,5	47	<b>EON2P129</b>				+ 83 €								
120x90	4,5	209,5	47	<b>EON2P290</b>							2.720 €	2.720 €	2.827 €	3.029 €	3.029 €	3.137 €
120x90	11,5	216,5	47	<b>EON2P299</b>												

### IDROMASSAGGIO CON TETTuccio CON SOFFIONE (PLAFONIERA LUMINOSA CON INTERRUOTORE)

					D	S	M	T	1F-	1	AA	AB	AK	UA	UB	UK
120x80	4,5	214	47	<b>EON2P120</b>							3.145 €	3.145 €	3.252 €	3.454 €	3.454 €	3.560 €
120x80	11,5	221	47	<b>EON2P129</b>				+ 83 €								
120x90	4,5	214	47	<b>EON2P290</b>							3.242 €	3.242 €	3.347 €	3.550 €	3.550 €	3.657 €
120x90	11,5	221	47	<b>EON2P299</b>												

### HAMMAM (CROMOLIGHT CON TELECOMANDO)

					D	S	M	T	1N-	1	AA	AB	AK	UA	UB	UK
120x80	4,5	229,5	47	<b>EON2P120</b>	●	●		●	●	●	3.928 €	3.928 €	4.033 €	4.237 €	4.237 €	4.343 €
120x80	11,5	236,5	47	<b>EON2P129</b>				+ 83 €								
120x90	4,5	229,5	47	<b>EON2P290</b>							4.023 €	4.023 €	4.130 €	4.332 €	4.332 €	4.439 €
120x90	11,5	236,5	47	<b>EON2P299</b>												





EON

EON 2P HAMMAM CROMO

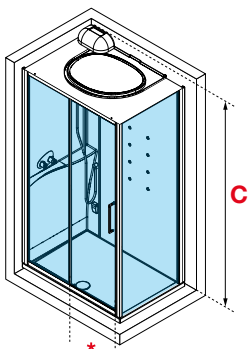

**S** Sinistra

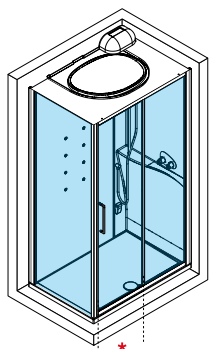

**D** Destra

**OPTIONAL**

	<b>SEDILE IN ACRILICO OPALINO</b>				
	<table border="1"> <tr> <th>Codice</th> <th>Prezzo</th> </tr> <tr> <td><b>SED030PL</b></td> <td>369 €</td> </tr> </table>	Codice	Prezzo	<b>SED030PL</b>	369 €
Codice	Prezzo				
<b>SED030PL</b>	369 €				

## CABINA MULTIFUNZIONE PER NICCHIA, APERTURA 1 ANTA SCORREVOLE E 1 FISSA IN LINEA

Misure				Codice	Installazione		Miscelatore		Idromassaggio	Vetro	Scelta finitura					
Dimensioni (cm)	Piatto doccia (cm)	Altezza totale (cm)	Entrata (cm)		D	S	M	T			Pannello bianco lucido			Pannello bianco opaco		
				AA	AB	AK	UA	UB	UK							
									1	Bianco	Silver	Cromo	Bianco	Silver	Cromo	

### STANDARD SENZA TETTuccio IN NICCHIA

					D	S	M-	T-		1	AA	AB	AK	UA	UB	UK
120x80	4,5	209,5	48	<b>EON2PN120</b>							2.322 €	2.322 €	2.428 €	2.630 €	2.630 €	2.737 €
120x80	11,5	216,5	48	<b>EON2PN129</b>												
120x90	4,5	209,5	48	<b>EON2PN290</b>				+ 83 €			2.418 €	2.418 €	2.524 €	2.727 €	2.727 €	2.833 €
120x90	11,5	216,5	48	<b>EON2PN299</b>												

### STANDARD CON TETTuccio IN NICCHIA (PLAFONIERA LUMINOSA CON INTERRUOTORE)

					D	S	M	T	T-	1	AA	AB	AK	UA	UB	UK
120x80	4,5	214	48	<b>EON2PN120</b>							2.788 €	2.788 €	2.894 €	3.098 €	3.098 €	3.203 €
120x80	11,5	221	48	<b>EON2PN129</b>												
120x90	4,5	214	48	<b>EON2PN290</b>				+ 83 €			2.884 €	2.884 €	2.990 €	3.193 €	3.193 €	3.299 €
120x90	11,5	221	48	<b>EON2PN299</b>												

### IDROMASSAGGIO SENZA TETTuccio IN NICCHIA

					D	S	M	T	1-	1	AA	AB	AK	UA	UB	UK
120x80	4,5	209,5	48	<b>EON2PN120</b>							2.624 €	2.624 €	2.730 €	2.933 €	2.933 €	3.039 €
120x80	11,5	216,5	48	<b>EON2PN129</b>												
120x90	4,5	209,5	48	<b>EON2PN290</b>				+ 83 €			2.720 €	2.720 €	2.827 €	3.029 €	3.029 €	3.137 €
120x90	11,5	216,5	48	<b>EON2PN299</b>												

### IDROMASSAGGIO CON TETTuccio CON SOFFIONE (PLAFONIERA LUMINOSA CON INTERRUOTORE)

					D	S	M	T	1F-	1	AA	AB	AK	UA	UB	UK
120x80	4,5	214	48	<b>EON2PN120</b>							3.145 €	3.145 €	3.252 €	3.454 €	3.454 €	3.560 €
120x80	11,5	221	48	<b>EON2PN129</b>												
120x90	4,5	214	48	<b>EON2PN290</b>				+ 83 €			3.242 €	3.242 €	3.347 €	3.550 €	3.550 €	3.657 €
120x90	11,5	221	48	<b>EON2PN299</b>												

### HAMMAM IN NICCHIA (CROMOLIGHT CON TELECOMANDO)

					D	S	M	T	1N-	1	AA	AB	AK	UA	UB	UK
120x80	4,5	229,5	48	<b>EON2PN120</b>							3.928 €	3.928 €	4.033 €	4.237 €	4.237 €	4.343 €
120x80	11,5	236,5	48	<b>EON2PN129</b>												
120x90	4,5	229,5	48	<b>EON2PN290</b>				+ 83 €			4.023 €	4.023 €	4.130 €	4.332 €	4.332 €	4.439 €
120x90	11,5	236,5	48	<b>EON2PN299</b>												



EON

EON 2P HAMMAM IN NICCHIA CROMO VERSIONE DESTRA

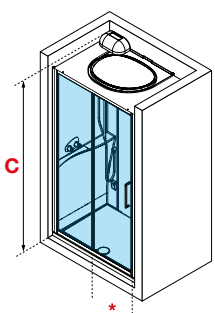

**S** Sinistra

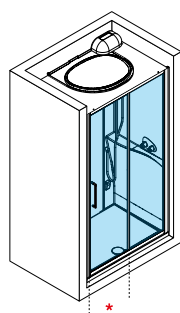

**D** Destra

**OPTIONAL**

	<b>SEDILE IN ACRILICO OPALINO</b>				
	<table border="1"> <tr> <th>Codice</th> <th>Prezzo</th> </tr> <tr> <td><b>SED030PL</b></td> <td>369 €</td> </tr> </table>	Codice	Prezzo	<b>SED030PL</b>	369 €
Codice	Prezzo				
<b>SED030PL</b>	369 €				

## CABINA MULTIFUNZIONE, APERTURA 2 ANTE SCORREVOLI E 2 FISSE

Misure				Codice	Installazione		Miscelatore		Idromas- saggio	Vetro	Scelta finitura					
Dimensioni (cm)	Piatto doccia (cm)	Altezza totale (cm)	Entrata (cm)		D	S	M	T			Pannello bianco lucido			Pannello bianco opaco		
				AA					AB	AK	UA	UB	UK			
										1	Bianco	Silver	Cromo	Bianco	Silver	Cromo

### STANDARD SENZA TETTuccio

					D	S	M-	T-		1	AA	AB	AK	UA	UB	UK
80x80	4,5	209,5	38	<b>EONA80</b>							1.993 €	1.993 €	2.099 €	2.302 €	2.302 €	2.409 €
80x80	11,5	216,5	38	<b>EONA89</b>												
90x90	4,5	209,5	45	<b>EONA90</b>							2.294 €	2.294 €	2.399 €	2.603 €	2.603 €	2.709 €
90x90	11,5	216,5	45	<b>EONA99</b>				+ 83 €								
100x80	4,5	209,5	45	<b>EONA100</b>							2.267 €	2.267 €	2.374 €	2.575 €	2.575 €	2.683 €
100x80	11,5	216,5	45	<b>EONA109</b>												

### STANDARD CON TETTuccio (PLAFONIERA LUMINOSA CON INTERRUOTORE)

					D	S	M	T	T-	1	AA	AB	AK	UA	UB	UK
80x80	4,5	214	38	<b>EONA80</b>							2.459 €	2.459 €	2.565 €	2.768 €	2.768 €	2.874 €
80x80	11,5	221	38	<b>EONA89</b>												
90x90	4,5	214	45	<b>EONA90</b>							2.762 €	2.762 €	2.868 €	3.070 €	3.070 €	3.178 €
90x90	11,5	221	45	<b>EONA99</b>				+ 83 €								
100x80	4,5	214	45	<b>EONA100</b>							2.733 €	2.733 €	2.840 €	3.042 €	3.042 €	3.149 €
100x80	11,5	221	45	<b>EONA109</b>												

### IDROMASSAGGIO SENZA TETTuccio

					D	S	M	T	1-	1	AA	AB	AK	UA	UB	UK
80x80	4,5	209,5	38	<b>EONA80</b>							2.294 €	2.294 €	2.399 €	2.603 €	2.603 €	2.709 €
80x80	11,5	216,5	38	<b>EONA89</b>												
90x90	4,5	209,5	45	<b>EONA90</b>							2.597 €	2.597 €	2.702 €	2.905 €	2.905 €	3.012 €
90x90	11,5	216,5	45	<b>EONA99</b>				+ 83 €								
100x80	4,5	209,5	45	<b>EONA100</b>							2.568 €	2.568 €	2.675 €	2.878 €	2.878 €	2.984 €
100x80	11,5	216,5	45	<b>EONA109</b>												

### IDROMASSAGGIO CON TETTuccio CON SOFFIONE (PLAFONIERA LUMINOSA CON INTERRUOTORE)

					D	S	M	T	1F-	1	AA	AB	AK	UA	UB	UK
80x80	4,5	214	38	<b>EONA80</b>							2.815 €	2.815 €	2.923 €	3.124 €	3.124 €	3.232 €
80x80	11,5	221	38	<b>EONA89</b>												
90x90	4,5	214	45	<b>EONA90</b>							3.117 €	3.117 €	3.224 €	3.425 €	3.425 €	3.533 €
90x90	11,5	221	45	<b>EONA99</b>				+ 83 €								
100x80	4,5	214	45	<b>EONA100</b>							3.090 €	3.090 €	3.197 €	3.400 €	3.400 €	3.505 €
100x80	11,5	221	45	<b>EONA109</b>												

### HAMMAM (CROMOLIGHT CON TELECOMANDO)

					D	S	M	T	1N-	1	AA	AB	AK	UA	UB	UK
80x80	4,5	229,5	38	<b>EONA80</b>							3.598 €	3.598 €	3.705 €	3.908 €	3.908 €	4.014 €
80x80	11,5	236,5	38	<b>EONA89</b>												
90x90	4,5	229,5	45	<b>EONA90</b>							3.899 €	3.899 €	4.007 €	4.209 €	4.209 €	4.315 €
90x90	11,5	236,5	45	<b>EONA99</b>				+ 83 €								
100x80	4,5	229,5	45	<b>EONA100</b>	●	●		●	●	●	3.873 €	3.873 €	3.979 €	4.182 €	4.182 €	4.288 €
100x80	11,5	236,5	45	<b>EONA109</b>												



EON

EON A HAMMAM CROMO

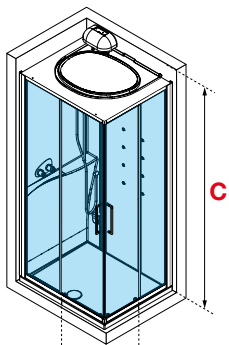

**S** Sinistra

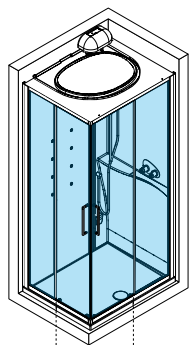

**D** Destra

**OPTIONAL**

		<b>SEDILE IN ACRILICO OPALINO</b>	
<b>Codice</b>	<b>Prezzo</b>		
<b>SED030PL</b>	369 €		

## CABINA MULTIFUNZIONE, APERTURA 1 ANTA BATTENTE CON FISSO LATERALE

Misure				Codice	Miscelatore		Idromas- saggio	Vetro	Scelta finitura					
Dimensioni (cm)	Piatto doccia (cm)	Altezza totale (cm)	Entrata (cm)		M	T			Pannello bianco lucido			Pannello bianco opaco		
								1	AA	AB	AK	UA	UB	UK
		<b>C</b>	*		Meccanico	Termosta- tico		Trasparente	Bianco	Silver	Cromo	Bianco	Silver	Cromo

### STANDARD SENZA TETTUCCIO



					M-	T-		1	AA	AB	AK	UA	UB	UK
90x90	4,5	209,5	68	<b>EONGF90</b>					2.294 €	2.294 €	2.399 €	2.603 €	2.603 €	2.709 €
90x90	11,5	216,5	68	<b>EONGF99</b>		+ 83 €								

### STANDARD CON TETTUCCIO (PLAFONIERA LUMINOSA CON INTERRUTTORE)



					M	T	T-	1	AA	AB	AK	UA	UB	UK
90x90	4,5	214	68	<b>EONGF90</b>					2.762 €	2.762 €	2.868 €	3.070 €	3.070 €	3.178 €
90x90	11,5	221	68	<b>EONGF99</b>		+ 83 €								

### IDROMASSAGGIO SENZA TETTUCCIO



					M	T	1-	1	AA	AB	AK	UA	UB	UK
90x90	4,5	209,5	68	<b>EONGF90</b>					2.597 €	2.597 €	2.702 €	2.905 €	2.905 €	3.012 €
90x90	11,5	216,5	68	<b>EONGF99</b>		+ 83 €								

### IDROMASSAGGIO CON TETTUCCIO CON SOFFIONE (PLAFONIERA LUMINOSA CON INTERRUTTORE)



					M	T	1F-	1	AA	AB	AK	UA	UB	UK
90x90	4,5	214	68	<b>EONGF90</b>					3.117 €	3.117 €	3.224 €	3.425 €	3.425 €	3.533 €
90x90	11,5	221	68	<b>EONGF99</b>		+ 83 €								

### HAMMAM (CROMOLIGHT CON TELECOMANDO)



					M	T	1N-	1	AA	AB	AK	UA	UB	UK
90x90	4,5	229,5	68	<b>EONGF90</b>					3.899 €	3.899 €	4.007 €	4.209 €	4.209 €	4.315 €
90x90	11,5	236,5	68	<b>EONGF99</b>		+ 83 €								

LA PORTA ED IL FISSO SONO REVERSIBILI PER INSTALLAZIONE A DESTRA O SINISTRA







EON

EON GF HAMMAM CROMO

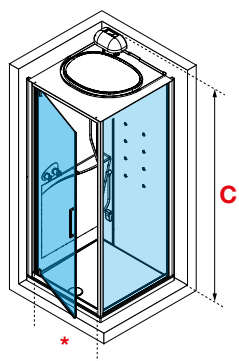

Installazione porta a sinistra

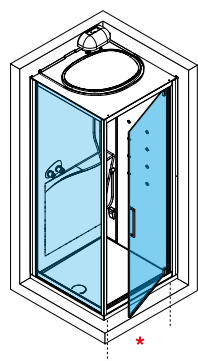

Installazione porta a destra

OPTIONAL

	SEDILE IN ACRILICO OPALINO				
	<table border="1"> <tr> <th>Codice</th> <th>Prezzo</th> </tr> <tr> <td><b>SED030PL</b></td> <td>369 €</td> </tr> </table>	Codice	Prezzo	<b>SED030PL</b>	369 €
Codice	Prezzo				
<b>SED030PL</b>	369 €				

## CABINA MULTIFUNZIONE PER NICCHIA, APERTURA 1 ANTA BATTENTE

Misure				Codice	Miscelatore		Idromas- saggio	Vetro	Scelta finitura					
Dimensioni (cm)	Piatto doccia (cm)	Altezza totale (cm)	Entrata (cm)		M	T			Pannello bianco lucido			Pannello bianco opaco		
												1	AA	AB
		<b>C</b>	*		Meccanico	Termostatico		Trasparente	Bianco	Silver	Cromo	Bianco	Silver	Cromo

### STANDARD SENZA TETTuccio IN NICCHIA



					M-	T-		1	AA	AB	AK	UA	UB	UK
80x80	4,5	209,5	56	<b>EONGN80</b>					1.993 €	1.993 €	2.099 €	2.302 €	2.302 €	2.409 €
80x80	11,5	216,5	56	<b>EONGN89</b>										
						+ 83 €								
90x90	4,5	209,5	66	<b>EONGN90</b>					2.294 €	2.294 €	2.399 €	2.603 €	2.603 €	2.709 €
90x90	11,5	216,5	66	<b>EONGN99</b>										

### STANDARD CON TETTuccio IN NICCHIA (PLAFONIERA LUMINOSA CON INTERRUTTORE)



					M	T	T-	1	AA	AB	AK	UA	UB	UK
80x80	4,5	214	56	<b>EONGN80</b>					2.459 €	2.459 €	2.565 €	2.768 €	2.768 €	2.874 €
80x80	11,5	221	56	<b>EONGN89</b>										
						+ 83 €								
90x90	4,5	214	66	<b>EONGN90</b>					2.762 €	2.762 €	2.868 €	3.070 €	3.070 €	3.178 €
90x90	11,5	221	66	<b>EONGN99</b>										

### IDROMASSAGGIO SENZA TETTuccio IN NICCHIA



					M	T	1-	1	AA	AB	AK	UA	UB	UK
80x80	4,5	209,5	56	<b>EONGN80</b>					2.294 €	2.294 €	2.399 €	2.603 €	2.603 €	2.709 €
80x80	11,5	216,5	56	<b>EONGN89</b>										
						+ 83 €								
90x90	4,5	209,5	66	<b>EONGN90</b>					2.597 €	2.597 €	2.702 €	2.905 €	2.905 €	3.012 €
90x90	11,5	216,5	66	<b>EONGN99</b>										

### IDROMASSAGGIO CON TETTuccio CON SOFFIONE (PLAFONIERA LUMINOSA CON INTERRUTTORE)



					M	T	1F-	1	AA	AB	AK	UA	UB	UK
80x80	4,5	214	56	<b>EONGN80</b>					2.815 €	2.815 €	2.923 €	3.124 €	3.124 €	3.232 €
80x80	11,5	221	56	<b>EONGN89</b>										
						+ 83 €								
90x90	4,5	214	66	<b>EONGN90</b>					3.117 €	3.117 €	3.224 €	3.425 €	3.425 €	3.533 €
90x90	11,5	221	66	<b>EONGN99</b>										

### HAMMAM IN NICCHIA (CROMOLIGHT CON TELECOMANDO)



					M	T	1N-	1	AA	AB	AK	UA	UB	UK
80x80	4,5	229,5	56	<b>EONGN80</b>					3.598 €	3.598 €	3.705 €	3.908 €	3.908 €	4.014 €
80x80	11,5	236,5	56	<b>EONGN89</b>										
						+ 83 €								
90x90	4,5	229,5	66	<b>EONGN90</b>					3.899 €	3.899 €	4.007 €	4.209 €	4.209 €	4.315 €
90x90	11,5	236,5	66	<b>EONGN99</b>										



EON

EON G IN NICCHIA HAMMAM CROMO

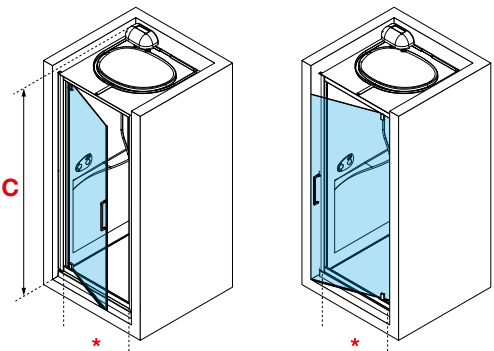

Installazione porta a sinistra

Installazione porta a destra

OPTIONAL

	SEDILE IN ACRILICO OPALINO				
	<table border="1"> <tr> <th>Codice</th> <th>Prezzo</th> </tr> <tr> <td><b>SED030PL</b></td> <td>369 €</td> </tr> </table>	Codice	Prezzo	<b>SED030PL</b>	369 €
Codice	Prezzo				
<b>SED030PL</b>	369 €				

## CABINA MULTIFUNZIONE SEMICIRCOLARE, APERTURA 2 ANTE SCORREVOLI E 2 FISSE

Misure				Codice	Miscelatore		Idromas- saggio	Vetro	Scelta finitura					
Dimensioni (cm)	Piatto doccia (cm)	Altezza totale (cm)	Entrata (cm)		M	T			Pannello bianco lucido			Pannello bianco opaco		
								1	AA	AB	AK	UA	UB	UK
		<b>C</b>	*		Meccanico	Termostatico		Trasparente	Bianco	Silver	Cromo	Bianco	Silver	Cromo
<b>STANDARD SENZA TETTuccio</b>														
					M-	T-		1	AA	AB	AK	UA	UB	UK
90x90	4,5	209,5	48	<b>EONR90</b>					2.500 €	2.500 €	2.607 €	2.809 €	2.809 €	2.915 €
90x90	11,5	216,5	48	<b>EONR99</b>		+ 83 €								
<b>STANDARD CON TETTuccio (PLAFONIERA LUMINOSA CON INTERRUTTORE)</b>														
					M	T	T-	1	AA	AB	AK	UA	UB	UK
90x90	4,5	214	48	<b>EONR90</b>					2.967 €	2.967 €	3.073 €	3.275 €	3.275 €	3.382 €
90x90	11,5	221	48	<b>EONR99</b>		+ 83 €								
<b>IDROMASSAGGIO SENZA TETTuccio</b>														
					M	T	1-	1	AA	AB	AK	UA	UB	UK
90x90	4,5	209,5	48	<b>EONR90</b>					2.802 €	2.802 €	2.908 €	3.110 €	3.110 €	3.217 €
90x90	11,5	216,5	48	<b>EONR99</b>		+ 83 €								
<b>IDROMASSAGGIO CON TETTuccio CON SOFFIONE (PLAFONIERA LUMINOSA CON INTERRUTTORE)</b>														
					M	T	1F-	1	AA	AB	AK	UA	UB	UK
90x90	4,5	214	48	<b>EONR90</b>					3.324 €	3.324 €	3.430 €	3.633 €	3.633 €	3.740 €
90x90	11,5	221	48	<b>EONR99</b>		+ 83 €								
<b>HAMMAM (CROMOLIGHT CON TELECOMANDO)</b>														
					M	T	1N-	1	AA	AB	AK	UA	UB	UK
90x90	4,5	229,5	48	<b>EONR90</b>					4.105 €	4.105 €	4.213 €	4.414 €	4.414 €	4.522 €
90x90	11,5	236,5	48	<b>EONR99</b>		+ 83 €								



EON

EON R HAMMAM CROMO

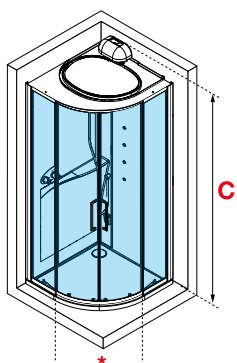

**OPTIONAL**

	<b>SEDILE IN ACRILICO OPALINO</b>	
	<b>Codice</b>	<b>Prezzo</b>
	<b>SED030PL</b>	369 €



## NEW HOLIDAY | FINITURE

### FINITURE STRUTTURA



Bianco  
cod D



Silver  
cod B

### FINITURA VETRI



Trasparente  
spessore 6 mm



Aqua  
spessore 6 mm

## NEW HOLIDAY | FUNZIONI E DOTAZIONI (disponibili a seconda dell'allestimento)



-  Miscelatore meccanico o termostatico e doccia a mano con flessibile orientabile
-  Tettuccio con soffione doccia Ø 20 cm
-  Sistema di idromassaggio verticale 5 jets orientabili
-  Sistema di idromassaggio cervicale 2 jets orientabili
-  Rotopoggia (3 jets orientabili)
-  Sedile
-  2 ripiani portaoggetti
-  Telecomando Touch Screen: sauna regolabile, radio, orologio, allarme
-  HAMMAM (Sauna di vapore + erogatore di vapore con dispenser di aromi)



NEW HOLIDAY



La più completa proposta idromassaggio Novellini



Sedile integrato



Telecomando touch screen



Avvolgere il corpo con una soffice nuvola di vapore e di aromi di oli essenziali

# NEW HOLIDAY



# NEW HOLIDAY 2P+F



CABINA MULTIFUNZIONALE ASIMMETRICA, APERTURA 1 ANTA SCORREVOLE E 1 FISSA IN LINEA CON 1 FISSO LATERALE

Misure			Codice	Installazione		Miscelatore		Idromassaggio	Vetro		Scelta finitura	
Dimensioni	Altezza totale (cm)	Entrata (cm)		D	S	M	T		1	2	Finitura bianca	Finitura silver
	<b>C</b>	*		Destra	Sinistra	Meccanico	Termostatico		Trasparente	Aqua	Bianco	Silver
<b>STANDARD SENZA TETTuccio</b>												
				D	S	M-	T-		1	2	D	B
100 x 70	206	38	<b>NNH2P100</b>				+ 90 €				1.969 €	1.969 €
120 x 80	206	47	<b>NNH2P120</b>	-	-						2.155 €	2.155 €
<b>STANDARD CON TETTuccio</b>												
				D	S	M	T	T-	1	2	D	B
100 x 70	217	38	<b>NNH2P100</b>				+ 90 €				2.393 €	2.393 €
120 x 80	217	47	<b>NNH2P120</b>	-	-						2.579 €	2.579 €
<b>IDROMASSAGGIO SENZA TETTuccio</b>												
				D	S	M	T	19-	1	2	D	B
100 x 70	206	38	<b>NNH2P100</b>				+ 90 €				2.277 €	2.277 €
120 x 80	206	47	<b>NNH2P120</b>	-	-						2.462 €	2.462 €
<b>IDROMASSAGGIO CON TETTuccio CON SOFFIONE</b>												
				D	S	M	T	19F-	1	2	D	B
100 x 70	217	38	<b>NNH2P100</b>				+ 90 €				2.759 €	2.759 €
120 x 80	217	47	<b>NNH2P120</b>	-	-						2.944 €	2.944 €
<b>HAMMAM</b>												
				D	S	M	T	19N-	1	2	D	B
100 x 70	225,5	38	<b>NNH2P100</b>				+ 90 €				3.545 €	3.545 €
120 x 80	225,5	47	<b>NNH2P120</b>	-	-						3.729 €	3.729 €

**120 X 80: LE PARETI DI FONDO SI POSSONO INVERTIRE PER INSTALLAZIONI A DESTRA O SINISTRA**





NEW HOLIDAY

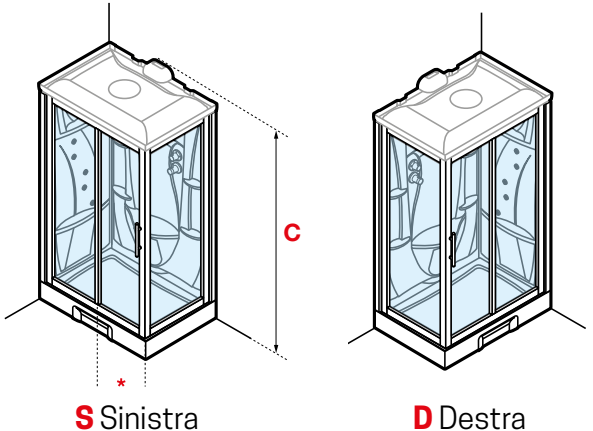

**OPTIONAL**

**PEDANA IN EVA,  
IMPERMEABILE ALL'ACQUA,  
ANTIBATTERICA E ATOSSICA.**



Misure	Pedana	Prezzo
100x70	<b>PEDNT107</b>	102 €
120x80	<b>PEDNT120</b>	115 €

# NEW HOLIDAY SF



CABINA MULTIFUNZIONE ASIMMETRICA: APERTURA 2 ANTE A SOFFIETTO + PARETE FISSA LATERALE

Misure			Codice	Miscelatore		Idromassaggio	Vetro		Scelta finitura	
Dimensioni	Altezza totale (cm)	Entrata (cm)		M	T		1	2	Finitura bianca	Finitura silver
	<b>C</b>	*		Meccanico	Termostatico		Trasparente	Aqua	Bianco	Silver
<b>STANDARD SENZA TETTUCCIO</b>										
				<b>M-</b>	<b>T-</b>		<b>1</b>	<b>2</b>	<b>D</b>	<b>B</b>
100 x 80	206	73	<b>NNHS100</b>		+ 90 €	-			2.098 €	2.098 €
<b>STANDARD CON TETTUCCIO</b>										
				<b>M</b>	<b>T</b>	<b>T-</b>	<b>1</b>	<b>2</b>	<b>D</b>	<b>B</b>
100 x 80	217	73	<b>NNHS100</b>		+ 90 €				2.522 €	2.522 €
<b>IDROMASSAGGIO SENZA TETTUCCIO</b>										
				<b>M</b>	<b>T</b>	<b>19-</b>	<b>1</b>	<b>2</b>	<b>D</b>	<b>B</b>
100 x 80	206	73	<b>NNHS100</b>		+ 90 €				2.405 €	2.405 €
<b>IDROMASSAGGIO CON TETTUCCIO CON SOFFIONE</b>										
				<b>M</b>	<b>T</b>	<b>19F-</b>	<b>1</b>	<b>2</b>	<b>D</b>	<b>B</b>
100 x 80	217	73	<b>NNHS100</b>		+ 90 €				2.887 €	2.887 €
<b>HAMMAM</b>										
				<b>M</b>	<b>T</b>	<b>19N-</b>	<b>1</b>	<b>2</b>	<b>D</b>	<b>B</b>
100 x 80	225,5	73	<b>NNHS100</b>		+ 90 €				3.673 €	3.673 €

LE PARETI DI FONDO SI POSSONO INVERTIRE PER INSTALLAZIONI A DESTRA O SINISTRA



NEW HOLIDAY

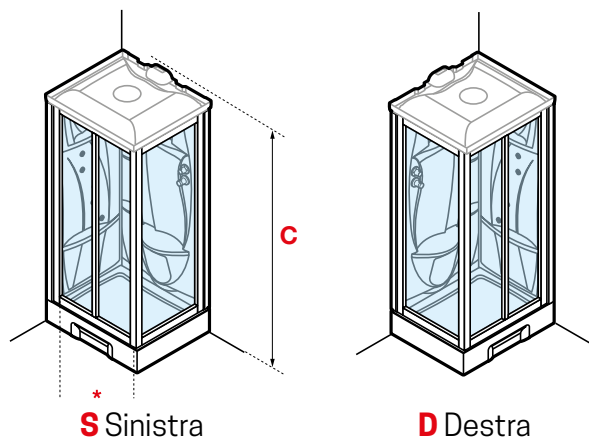

**OPTIONAL**

**PEDANA IN EVA,  
IMPERMEABILE ALL'ACQUA,  
ANTIBATTERICA E ATOSSICA.**

Misure	Pedana	Prezzo
100x80	<b>PEDNT100</b>	102 €

# NEW HOLIDAY A



CABINA MULTIFUNZIONE, APERTURA 2 ANTE SCORREVOLI E 2 FISSE

Misure			Codice	Miscelatore		Idromassaggio	Vetro		Scelta finitura	
Dimensioni	Altezza totale (cm)	Entrata (cm)		M	T		1	2	Finitura bianca	Finitura silver
	<b>C</b>	*		Meccanico	Termostatico		Trasparente	Aqua	Bianco	Silver
<b>STANDARD SENZA TETTUCCIO</b>										
				<b>M-</b>	<b>T-</b>		<b>1</b>	<b>2</b>	<b>D</b>	<b>B</b>
80 x 80	206	40	<b>NNHA80</b>		+ 90 €	-			1.854 €	1.854 €
90 x 90	206	46	<b>NNHA90</b>			-			2.127 €	2.127 €
<b>STANDARD CON TETTUCCIO</b>										
				<b>M</b>	<b>T</b>	<b>T-</b>	<b>1</b>	<b>2</b>	<b>D</b>	<b>B</b>
80 x 80	217	40	<b>NNHA80</b>		+ 90 €				2.277 €	2.277 €
90 x 90	217	46	<b>NNHA90</b>						2.549 €	2.549 €
<b>IDROMASSAGGIO SENZA TETTUCCIO</b>										
				<b>M</b>	<b>T</b>	<b>19-</b>	<b>1</b>	<b>2</b>	<b>D</b>	<b>B</b>
80 x 80	206	40	<b>NNHA80</b>		+ 90 €				2.160 €	2.160 €
90 x 90	206	46	<b>NNHA90</b>						2.433 €	2.433 €
<b>IDROMASSAGGIO CON TETTUCCIO CON SOFFIONE</b>										
				<b>M</b>	<b>T</b>	<b>19F-</b>	<b>1</b>	<b>2</b>	<b>D</b>	<b>B</b>
80 x 80	217	40	<b>NNHA80</b>		+ 90 €				2.642 €	2.642 €
90 x 90	217	46	<b>NNHA90</b>						2.914 €	2.914 €
<b>HAMMAM</b>										
				<b>M</b>	<b>T</b>	<b>19N-</b>	<b>1</b>	<b>2</b>	<b>D</b>	<b>B</b>
80 x 80	225,5	40	<b>NNHA80</b>		+ 90 €				3.427 €	3.427 €
90 x 90	225,5	46	<b>NNHA90</b>						3.702 €	3.702 €

LE PARETI DI FONDO SI POSSONO INVERTIRE  
PER INSTALLAZIONI A DESTRA O SINISTRA (SOLO PER MOD. A80)



NEW HOLIDAY

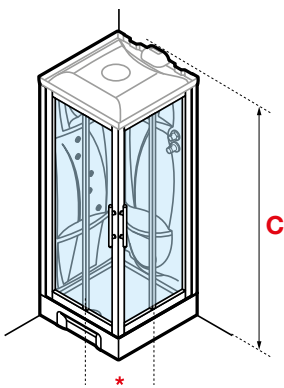

Installazione a Sinistra

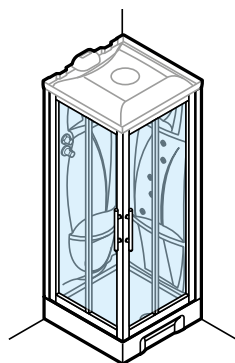

Installazione a Destra

**OPTIONAL**



**PEDANA IN EVA,  
IMPERMEABILE ALL'ACQUA,  
ANTIBATTERICA E ATOSSICA.**

Misure	Pedana	Prezzo
80x80	<b>PEDNTQ80</b>	94 €
90x90	<b>PEDNTQ90</b>	102 €

# NEW HOLIDAY GF



CABINA MULTIFUNZIONE, APERTURA 1 ANTA BATTENTE CON FISSO LATERALE

Misure			Codice	Miscelatore		Idromassaggio	Vetro		Scelta finitura	
Dimensioni	Altezza totale (cm)	Entrata (cm)		M	T		1	2	Finitura bianca	Finitura silver
	<b>C</b>	*		Meccanico	Termostatico	Trasparente	Aqua	Bianco	Silver	
<b>STANDARD SENZA TETTUCCIO</b>										
				<b>M-</b>	<b>T-</b>		<b>1</b>	<b>2</b>	<b>D</b>	<b>B</b>
80 x 80	206	55	<b>NNHGF80</b>			-			1.854 €	1.854 €
90 x 90	206	65	<b>NNHGF90</b>		+ 90 €	-			2.127 €	2.127 €
<b>STANDARD CON TETTUCCIO</b>										
				<b>M</b>	<b>T</b>	<b>T-</b>	<b>1</b>	<b>2</b>	<b>D</b>	<b>B</b>
80 x 80	217	55	<b>NNHGF80</b>						2.277 €	2.277 €
90 x 90	217	65	<b>NNHGF90</b>		+ 90 €				2.549 €	2.549 €
<b>IDROMASSAGGIO SENZA TETTUCCIO</b>										
				<b>M</b>	<b>T</b>	<b>19-</b>	<b>1</b>	<b>2</b>	<b>D</b>	<b>B</b>
80 x 80	206	55	<b>NNHGF80</b>						2.160 €	2.160 €
90 x 90	206	65	<b>NNHGF90</b>		+ 90 €				2.433 €	2.433 €
<b>IDROMASSAGGIO CON TETTUCCIO CON SOFFIONE</b>										
				<b>M</b>	<b>T</b>	<b>19F-</b>	<b>1</b>	<b>2</b>	<b>D</b>	<b>B</b>
80 x 80	217	55	<b>NNHGF80</b>						2.642 €	2.642 €
90 x 90	217	65	<b>NNHGF90</b>		+ 90 €				2.914 €	2.914 €
<b>HAMMAM</b>										
				<b>M</b>	<b>T</b>	<b>19N-</b>	<b>1</b>	<b>2</b>	<b>D</b>	<b>B</b>
80 x 80	225,5	55	<b>NNHGF80</b>						3.427 €	3.427 €
90 x 90	225,5	65	<b>NNHGF90</b>		+ 90 €				3.702 €	3.702 €

**GF 80: LE PARETI DI FONDO SI POSSONO INVERTIRE PER INSTALLAZIONI A DESTRA O SINISTRA**



GF 80X80

GF 90X90

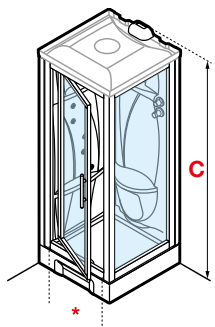

Installazione a Sinistra

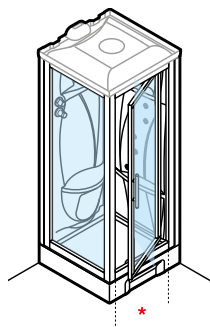

Installazione a Destra

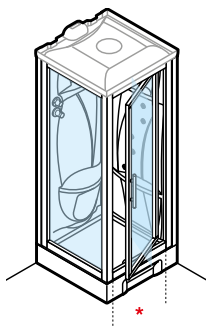

Installazione  
solamente a Destra

OPTIONAL



PEDANA IN EVA,  
IMPERMEABILE ALL'ACQUA,  
ANTIBATTERICA E ATOSSICA.

Misure	Pedana	Prezzo
80x80	<b>PEDNTQ80</b>	94 €
90x90	<b>PEDNTQ90</b>	102 €

# NEW HOLIDAY R



CABINA MULTIFUNZIONE SEMICIRCOLARE, APERTURA 2 ANTE SCORREVOLI E 2 FISSE

Misure			Codice	Miscelatore		Idromas- saggio	Vetro		Scelta finitura	
Dimensioni	Altezza totale (cm)	Entrata (cm)		M	T		1	2	Finitura bianca	Finitura silver
	<b>C</b>	*		Meccanico	Termostatico		Trasparente	Aqua	Bianco	Silver
<b>STANDARD SENZA TETTuccio</b>										
				<b>M-</b>	<b>T-</b>		<b>1</b>	<b>2</b>	<b>D</b>	<b>B</b>
90 x 90	206	48	<b>NNHR90</b>		+ 90 €	-			2.313 €	2.313 €
<b>STANDARD CON TETTuccio</b>										
				<b>M</b>	<b>T</b>	<b>T-</b>	<b>1</b>	<b>2</b>	<b>D</b>	<b>B</b>
90 x 90	217	48	NNHR90		+ 90 €				2.735 €	2.735 €
<b>IDROMASSAGGIO SENZA TETTuccio</b>										
				<b>M</b>	<b>T</b>	<b>19-</b>	<b>1</b>	<b>2</b>	<b>D</b>	<b>B</b>
90 x 90	206	48	<b>NNHR90</b>		+ 90 €				2.620 €	2.620 €
<b>IDROMASSAGGIO CON TETTuccio CON SOFFIONE</b>										
				<b>M</b>	<b>T</b>	<b>19F-</b>	<b>1</b>	<b>2</b>	<b>D</b>	<b>B</b>
90 x 90	217	48	<b>NNHR90</b>		+ 90 €				3.102 €	3.102 €
<b>HAMMAM</b>										
				<b>M</b>	<b>T</b>	<b>19N-</b>	<b>1</b>	<b>2</b>	<b>D</b>	<b>B</b>
90 x 90	225,5	48	<b>NNHR90</b>		+ 90 €				3.888 €	3.888 €





NEW HOLIDAY

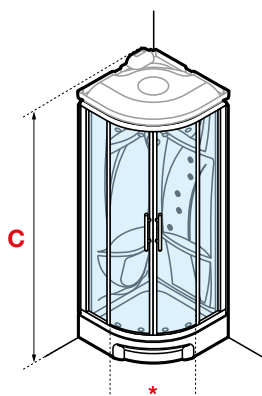

OPTIONAL



**PEDANA IN EVA,  
IMPERMEABILE ALL'ACQUA,  
ANTIBATTERICA E ATOSSICA.**

Misure	Pedana	Prezzo
90x90	<b>PEDNTR90</b>	94 €

# NEW HOLIDAY S2F

CABINA MULTIFUNZIONE: ASIMMETRICA, APERTURA 2 ANTE A SOFFIETTO CON 2 FISSI LATERALI

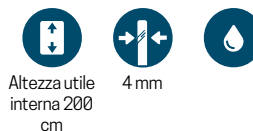

Misure			Codice	Miscelatore		Idromassaggio	Vetro		Scelta finitura	
Dimensioni	Altezza totale (cm)	Entrata (cm)		M	T		1	2	Finitura bianca	Finitura silver
	<b>C</b>	*		Meccanico	Termostatico	Trasparente	Aqua	Bianco	Silver	
<b>STANDARD SENZA TETTUCCIO</b>										
				<b>M-</b>	<b>T-</b>		<b>1</b>	<b>2</b>	<b>D</b>	<b>B</b>
100 x 80	206	73	<b>NNH2F100</b>		+ 90 €	-			2.098 €	2.098 €
<b>STANDARD CON TETTUCCIO</b>										
				<b>M</b>	<b>T</b>	<b>T-</b>	<b>1</b>	<b>2</b>	<b>D</b>	<b>B</b>
100 x 80	217	73	<b>NNH2F100</b>		+ 90 €				2.520 €	2.520 €
<b>IDROMASSAGGIO SENZA TETTUCCIO</b>										
				<b>M</b>	<b>T</b>	<b>19-</b>	<b>1</b>	<b>2</b>	<b>D</b>	<b>B</b>
100 x 80	206	73	<b>NNH2F100</b>		+ 90 €				2.405 €	2.405 €
<b>IDROMASSAGGIO CON TETTUCCIO</b>										
				<b>M</b>	<b>T</b>	<b>19F-</b>	<b>1</b>	<b>2</b>	<b>D</b>	<b>B</b>
100 x 80	217	73	<b>NNH2F100</b>		+ 90 €				2.885 €	2.885 €
<b>HAMMAM</b>										
				<b>M</b>	<b>T</b>	<b>19N-</b>	<b>1</b>	<b>2</b>	<b>D</b>	<b>B</b>
100 x 80	225,5	73	<b>NNH2F100</b>		+ 90 €				3.673 €	3.673 €

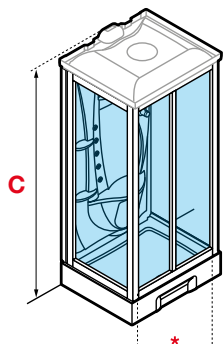

OPTIONAL

PEDANA IN EVA,  
IMPERMEABILE ALL'ACQUA,  
ANTIBATTERICA E ATOSSICA.



Misure	Pedana	Prezzo
100x80	<b>PEDNT100</b>	102 €



MEDIA GLASS 2P



MEDIA GLASS GF

## MEDIA GLASS | FINITURE

### FINITURE STRUTTURA



Bianco lucido

### FINITURA VETRI



Trasparente

## MEDIA GLASS | FUNZIONI E DOTAZIONI (disponibili a seconda dell'allestimento)



Miscelatore meccanico o termostatico e doccia a mano con flessibile orientabile

Tettuccio con soffione doccia

Ripiani d'appoggio



MEDIA GLASS A

MEDIA GLASS



Facilità di installazione  
direttamente in angolo



Pareti di fondo  
in vetro temprato da 4 mm



Ripiano d'appoggio



Saliscendi con snodo frontale

# MEDIA GLASS

# MEDIA GLASS 2P



**CABINA MULTIFUNZIONALE ASIMMETRICA,  
APERTURA 1 ANTA SCORREVOLE E 1 FISSA IN LINEA CON 1 FISSO LATERALE**

Misure			Codice	Miscelatore		Vetro	Scelta finitura
Dimensioni (cm)	Altezza totale (cm)	Entrata (cm)		M	T		Finitura bianco lucido
	<b>C</b>	*		M	T	1	AA
				Meccanico	Termostatico	Trasparente	Bianco

STANDARD								
Dimensioni (cm)	Altezza totale (cm)	Entrata (cm)	Codice	M-	T-	Vetro	AA	
120 X 80	210	47	<b>MEG2P120</b>	●	+ 80 €	●	2.127 €	

STANDARD CON TETTuccio E SOFFIONE								
Dimensioni (cm)	Altezza totale (cm)	Entrata (cm)	Codice	MF-	TF-	Vetro	AA	
120 X 80	226	47	<b>MEG2P120</b>		+ 80 €		2.387 €	





MEDIA GLASS

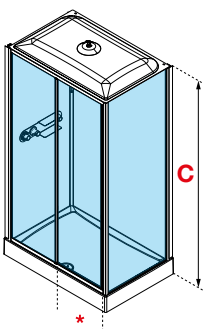

Installazione a sinistra

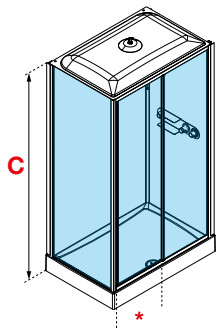

Installazione a destra

# MEDIA GLASS GF

CABINA MULTIFUNZIONE, APERTURA 1 ANTA BATTENTE CON FISSO LATERALE



Misure			Codice	Miscelatore		Vetro	Scelta finitura
Dimensioni (cm)	Altezza totale (cm)	Entrata (cm)		M	T	1	Finitura bianco lucido
	<b>C</b>	*		Meccanico	Termostatico	Trasparente	AA Bianco

STANDARD							
				M-	T-	1	AA
80 X 80	210	60	<b>MEGGF80</b>	•	+ 80 €	•	1.617 €
90 X 90	210	70	<b>MEGGF90</b>	•		•	1.933 €

STANDARD CON TETTUCCIO E SOFFIONE							
				MF-	TF-	1	AA
80 X 80	226	60	<b>MEGGF80</b>		+ 80 €		1.877 €
90 X 90	226	70	<b>MEGGF90</b>				2.193 €







MEDIA GLASS

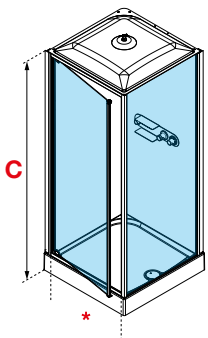

Installazione a sinistra

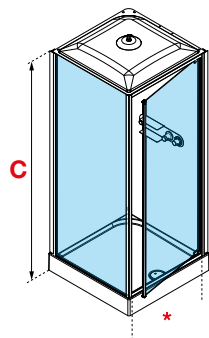

Installazione a destra

# MEDIA GLASS A

CABINA MULTIFUNZIONE, APERTURA 2 ANTE SCORREVOLI E 2 FISSE



207 cm



3 mm  
Porta



4 mm  
pareti



Misure			Codice	Miscelatore		Vetro	Scelta finitura	
Dimensioni (cm)	Altezza totale (cm)	Entrata (cm)		M	T		1	Finitura bianco lucido
	<b>C</b>	*		M	T	1	AA	
				Meccanico	Termostatico	Trasparente	Bianco	

STANDARD							
Dimensioni (cm)	Altezza totale (cm)	Entrata (cm)	Codice	Miscelatore	Vetro	Finitura	Prezzo
80 X 80	210	44	<b>MEGA80</b>	M-	T-	1	AA
90 X 90	210	48	<b>MEGA90</b>	•		•	1.641 €
90 X 70	210	36	<b>MEGA7090</b>	•	+ 80 €	•	1.835 €
100 X 70	210	48	<b>MEGA107</b>				1.932 €
100 X 80	210	50	<b>MEGA100</b>				

STANDARD CON TETTuccio E SOFFIONE							
Dimensioni (cm)	Altezza totale (cm)	Entrata (cm)	Codice	Miscelatore	Vetro	Finitura	Prezzo
80 X 80	226	44	<b>MEGA80</b>	MF-	TF-	1	AA
90 X 90	226	48	<b>MEGA90</b>				1.901 €
90 X 70	226	36	<b>MEGA7090</b>		+ 80 €		2.095 €
100 X 70	226	48	<b>MEGA107</b>				2.192 €
100 X 80	226	50	<b>MEGA100</b>				

80x80 - 90x90

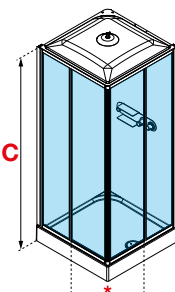

90x70 - 100x70 - 100x80

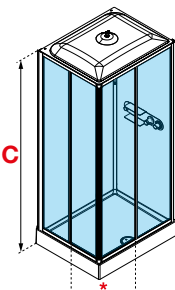

Installazione a destra

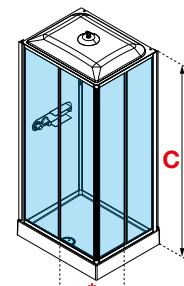

Installazione a sinistra



# MEDIA GLASS R

CABINA MULTIFUNZIONE SEMICIRCOLARE, APERTURA 2 ANTE SCORREVOLI E 2 FISSE



207 cm









3 mm  
Porta



4 mm  
pareti



Misure			Codice	Miscelatore		Vetro	Scelta finitura
Dimensioni (cm)	Altezza totale (cm)	Entrata (cm)		M	T		Finitura bianco lucido
	<b>C</b>	*		M	T	1	AA
				Meccanico	Termostatico	Trasparente	Bianco
<b>STANDARD</b>							 
90 X 90	210	48	<b>MEGR90</b>	M-	T-	1	AA
					+ 80 €		2.068 €
<b>STANDARD CON TETTuccio E SOFFIONE</b>							   
90 X 90	226	48	<b>MEGR90</b>	MF-	TF-	1	AA
					+ 80 €		2.328 €

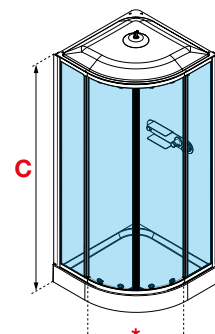

MEDIA GLASS

Costruzione del codice **Codice** + **Miscelatore** + **Vetro** + **Finitura** = Codice prodotto finale



## MEDIA | FINITURE

### FINITURE STRUTTURA



Bianco  
cod A



Silver  
cod B

### FINITURA VETRI



Trasparente  
spessore 3 mm

## MEDIA | FUNZIONI E DOTAZIONI (disponibili a seconda dell'allestimento)



Miscelatore meccanico o termostatico  
e doccia a mano con flessibile orientabile

Tettuccio con soffione doccia Ø 200 cm

Sistema di idromassaggio verticale  
3 jets orientabili

2 ripiani portaoggetti



MEDIA



Sistema idromassaggio verticale



Ripiano d'appoggio integrato



Tettuccio con soffione doccia integrato



Cabina dal design contemporaneo



# MEDIA

# MEDIA 2P



207 cm



3 mm



CABINA MULTIFUNZIONE ASIMMETRICA, APERTURA 1 ANTA SCORREVOLE E 1 FISSA IN LINEA CON 1 FISSO LATERALE



Misure			Codice	Miscelatore		Idromas- saggio	Vetro	Scelta finitura	
								Finitura bianco lucido	Finitura silver
Dimensioni (cm)	Altezza totale (cm)	Entrata (cm)		M	T		1	AA	AB
	<b>C</b>	*		Meccanico	Termostatico		Trasparente	Bianco	Silver
<b>STANDARD</b>									
				M-	T-		1	AA	AB
120 X 80	210	47	<b>ME22P120</b>	●	+ 83 €		●	1.758 €	1.899 €
<b>IDROMASSAGGIO SENZA TETTUCCIO</b>									
				M	T	1-	1	AA	AB
120 X 80	210	47	<b>ME22P120</b>		+ 83 €			2.017 €	2.159 €
<b>IDROMASSAGGIO CON TETTUCCIO E SOFFIONE</b>									
				M	T	1F-	1	AA	AB
120 X 80	226	47	<b>ME22P120</b>		+ 83 €			2.350 €	2.493 €

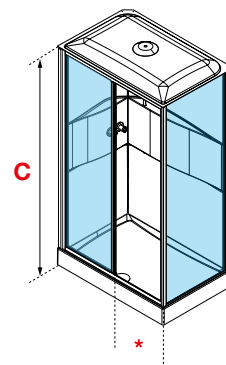

Installazione a sinistra

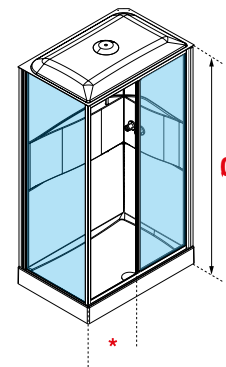

Installazione a destra



# MEDIA GF



207 cm



3 mm



CABINA MULTIFUNZIONE, APERTURA 1 ANTA BATTENTE CON FISSO LATERALE



Misure			Codice	Miscelatore		Idromassaggio	Vetro	Scelta finitura	
Dimensioni (cm)	Altezza totale (cm)	Entrata (cm)		M	T			Finitura bianco lucido	Finitura silver
	<b>C</b>	*		M	T		<b>1</b>	<b>AA</b>	<b>AB</b>
				Meccanico	Termostatico		Trasparente	Bianco	Silver

## STANDARD

				M-	T-		<b>1</b>	<b>AA</b>	<b>AB</b>
80 X 80	210	60	<b>ME2GF80</b>	●	+ 83 €		●	1.318 €	1.425 €
90 X 90	210	70	<b>ME2GF90</b>	●			●	1.412 €	1.525 €

## IDROMASSAGGIO SENZA TETTuccio

				M	T	1-	<b>1</b>	<b>AA</b>	<b>AB</b>
80 X 80	210	60	<b>ME2GF80</b>		+ 83 €			1.578 €	1.685 €
90 X 90	210	70	<b>ME2GF90</b>					1.670 €	1.784 €

## IDROMASSAGGIO CON TETTuccio E SOFFIONE

				M	T	1F-	<b>1</b>	<b>AA</b>	<b>AB</b>
80 X 80	226	60	<b>ME2GF80</b>		+ 83 €			1.912 €	2.017 €
90 X 90	226	70	<b>ME2GF90</b>					2.004 €	2.118 €

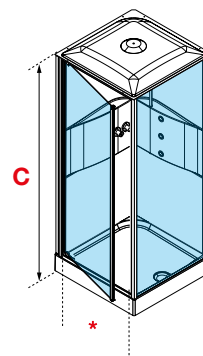

Installazione a sinistra

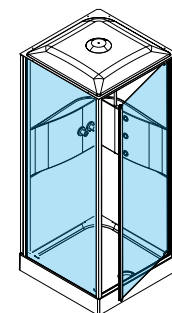

Installazione a destra

Costruzione del codice

Codice + Miscelatore + Idromassaggio + Vetro + Finitura = Codice prodotto finale



## CABINA MULTIFUNZIONE, APERTURA 2 ANTE SCORREVOLI E 2 FISSE

Misure			Codice	Miscelatore		Idromassaggio	Vetro	Scelta finitura	
Dimensioni (cm)	Altezza totale (cm)	Entrata (cm)		M	T			Finitura bianco lucido	Finitura silver
	<b>C</b>	*		M	T		<b>1</b>	<b>AA</b>	<b>AB</b>
				Meccanico	Termostatico		Trasparente	Bianco	Silver

### STANDARD

				M-	T-		1	AA	AB
80 X 80	210	44	<b>ME2A80</b>	●			●	1.225 €	1.323 €
90 X 90	210	48	<b>ME2A90</b>	●			●	1.318 €	1.425 €
90 X 70	210	36	<b>ME2A7090</b>		+ 83 €				
100 X 70	210	48	<b>ME2A107</b>					1.492 €	1.612 €
100 X 80	210	50	<b>ME2A100</b>						

### IDROMASSAGGIO SENZA TETTUCCIO

				M	T	1-	1	AA	AB
80 X 80	210	44	<b>ME2A80</b>					1.484 €	1.583 €
90 X 90	210	48	<b>ME2A90</b>					1.578 €	1.685 €
90 X 70	210	36	<b>ME2A7090</b>		+ 83 €				
100 X 70	210	48	<b>ME2A107</b>					1.750 €	1.872 €
100 X 80	210	50	<b>ME2A100</b>						

### IDROMASSAGGIO CON TETTUCCIO E SOFFIONE

				M	T	1F-	1	AA	AB
80 X 80	226	44	<b>ME2A80</b>					1.818 €	1.917 €
90 X 90	226	48	<b>ME2A90</b>					1.912 €	2.017 €
90 X 70	226	36	<b>ME2A7090</b>		+ 83 €				
100 X 70	226	48	<b>ME2A107</b>					2.084 €	2.204 €
100 X 80	226	50	<b>ME2A100</b>						





MEDIA

80x80 - 90x90

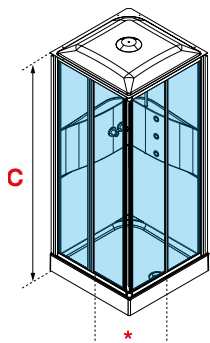

90x70 - 100x70 - 100x80

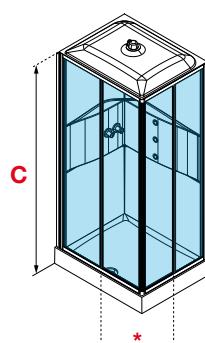

Installazione a sinistra

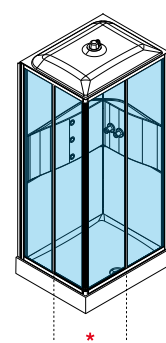

Installazione a destra

# MEDIA R



207 cm

3 mm

CABINA MULTIFUNZIONE SEMICIRCOLARE, APERTURA 2 ANTE SCORREVOLI E 2 FISSE



Misure			Codice	Miscelatore		Idromassaggio	Vetro	Scelta finitura	
Dimensioni (cm)	Altezza totale (cm)	Entrata (cm)		M	T			Finitura bianco lucido	Finitura silver
	<b>C</b>	*		Meccanico	Termostatico		1	AA	AB
							Trasparente	Bianco	Silver
<b>STANDARD</b>									
				<b>M-</b>	<b>T-</b>		<b>1</b>	<b>AA</b>	<b>AB</b>
90 X 90	210	48	<b>ME2R90</b>		+ 83 €			1.624 €	1.755 €
<b>IDROMASSAGGIO SENZA TETTuccio</b>									
				<b>M</b>	<b>T</b>	<b>1-</b>	<b>1</b>	<b>AA</b>	<b>AB</b>
90 X 90	210	48	<b>ME2R90</b>		+ 83 €			1.884 €	2.014 €
<b>IDROMASSAGGIO CON TETTuccio E SOFFIONE</b>									
				<b>M</b>	<b>T</b>	<b>1F-</b>	<b>1</b>	<b>AA</b>	<b>AB</b>
90 X 90	226	48	<b>ME2R90</b>		+ 83 €			2.218 €	2.348 €

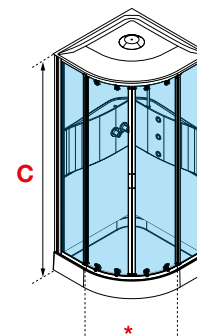

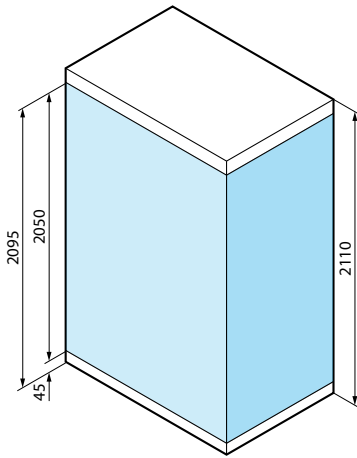

installazione a centro parete

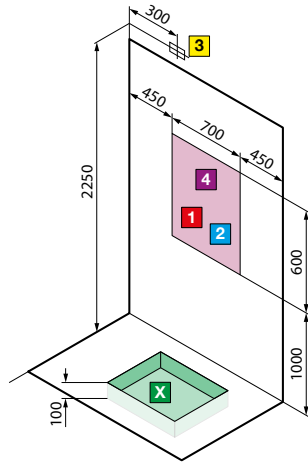

versione **sinistra**

versione **destra**

installazione ad angolo

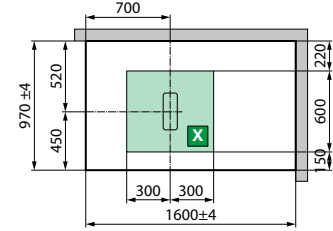
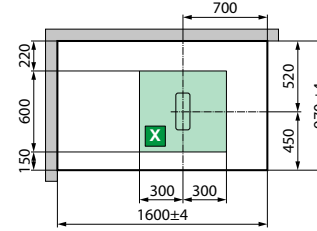
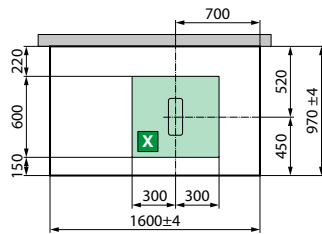
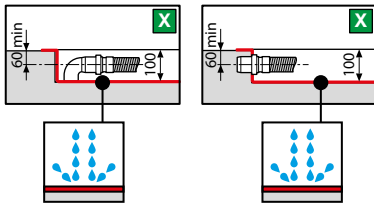
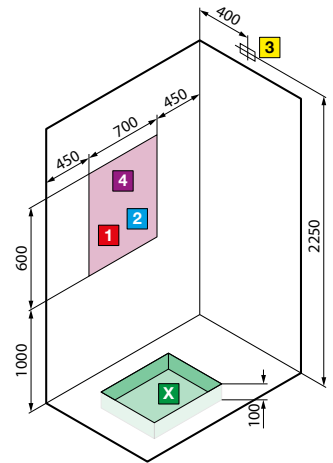
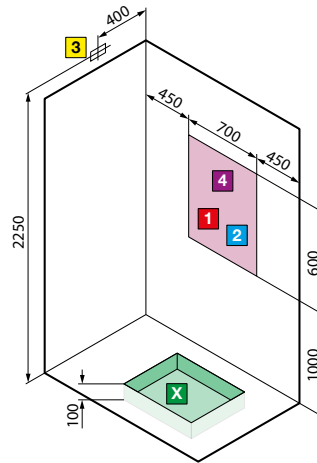

# SKILL DUAL PIATTO 125 MM

installazione a centro parete

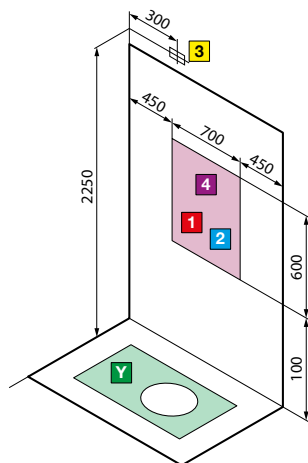
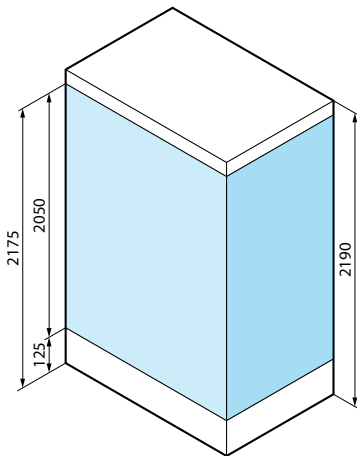

versione **sinistra**

versione **destra**

installazione ad angolo

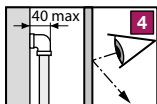
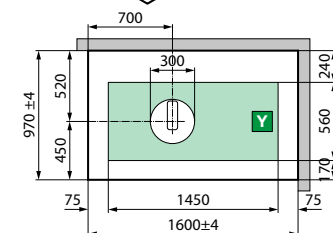
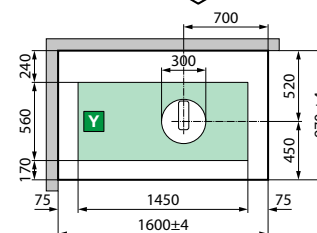
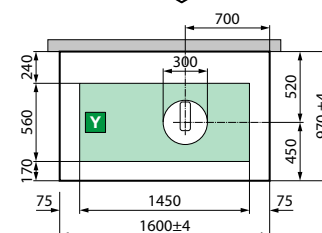
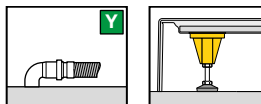
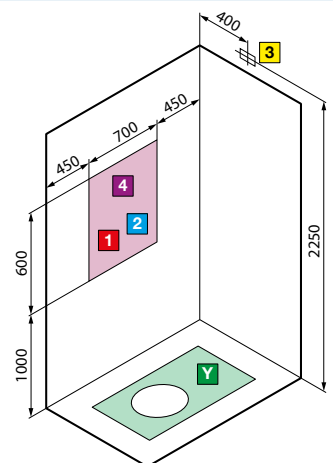
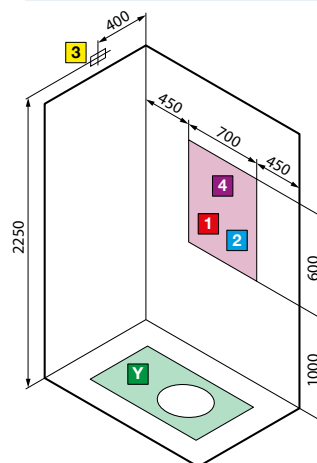

Non ispezionabile



EN55014-1  
EN55014-2

Il prodotto è certificato in accordo alle normative di compatibilità elettromagnetica



**ATTENZIONE!**

Può essere dannoso ai portatori di pacemakers

### CARATTERISTICHE IDRAULICHE:

Pressione dinamica ottimale 2÷5 bar  
Acqua calda 1/2"  
Acqua fredda 1/2"  
Allaccio sifone con raccordo  $\varnothing$  40 mm

### CARATTERISTICHE ELETTRICHE:

Tensione 220 - 230 V  
Frequenza 50/60 Hz  
Potenza massima assorbita: 5100 W  
Potenza nominale: 5000 W

**ATTENZIONE!** Installare a monte dell'apparecchio un interruttore differenziale da 30mA provvisto di interruttore onnipolare con apertura minima dei contatti  $\geq$  3 mm.

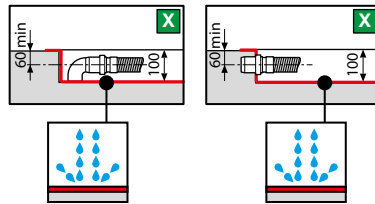
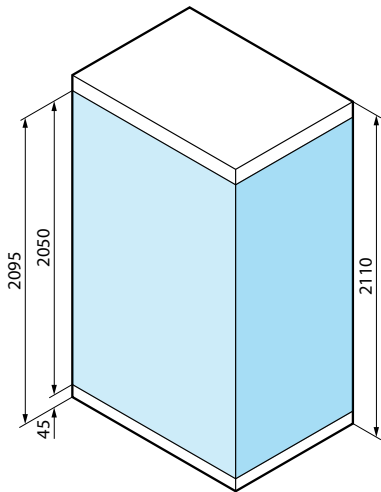

versione **sinistra**

versione **destra**

per modelli **A100x80 - A120x80 - A120x90 - A120x100**  
**- 2P 140x80**

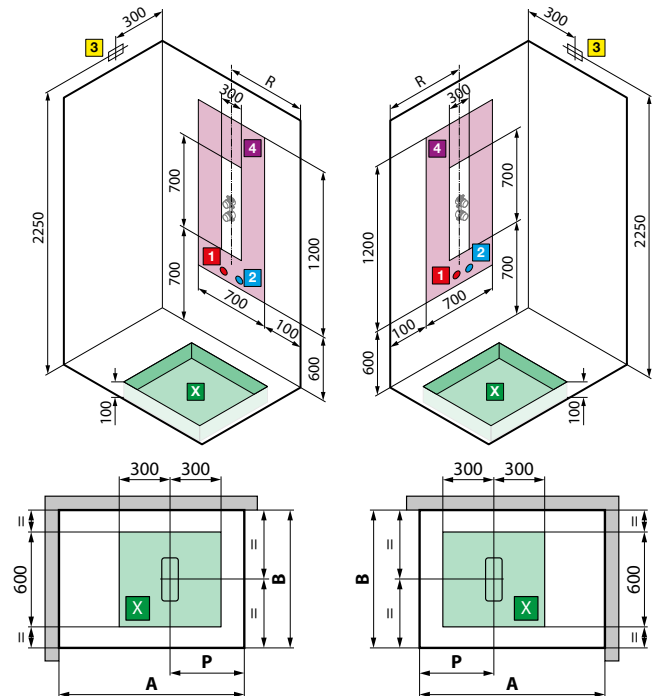

modello	A ± 2	B ± 2	P	R
<b>A100x80</b>	1000	800	400	450
<b>A120x80</b>	1200	800	500	550
<b>A120x90</b>	1200	900	500	550
<b>A120x100</b>	1200	1000	500	550
<b>2P140x80</b>	1400	800	600	650

# SKILL PIATTO 125 MM

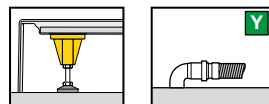
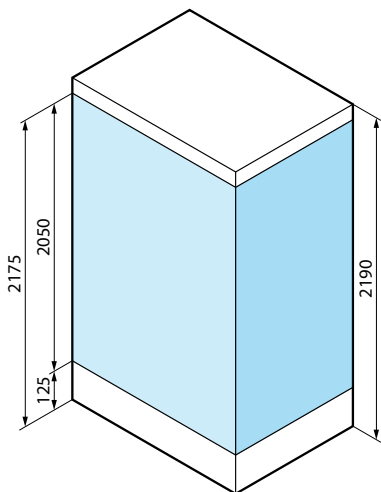

versione **sinistra**

versione **destra**

per modelli **A100x80 - A120x80 - A120x90 - A120x100**  
**- 2P 140x80**

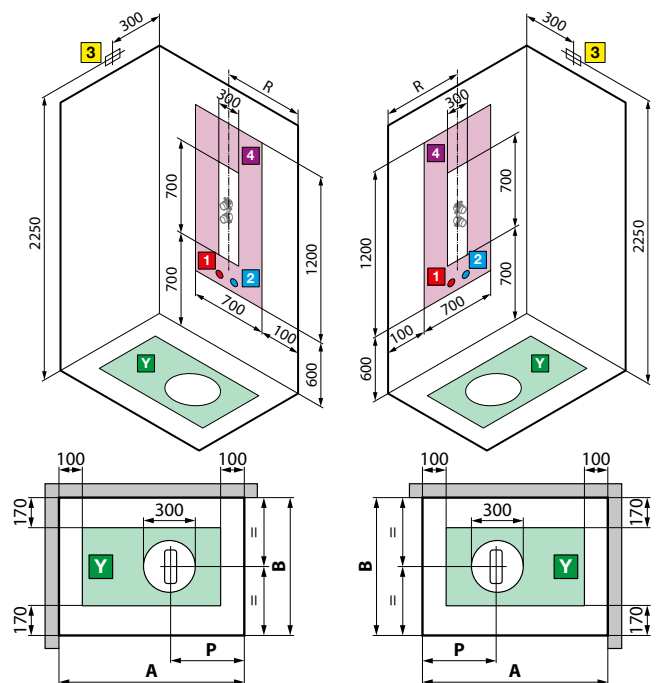

modello	A ± 2	B ± 2	P	R
<b>A100x80</b>	1000	800	400	450
<b>A120x80</b>	1200	800	500	550
<b>A120x90</b>	1200	900	500	550
<b>A120x100</b>	1200	1000	500	550
<b>2P140x80</b>	1400	800	600	650

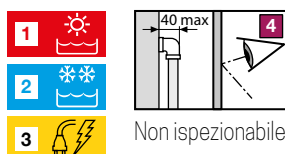

**EN55014-1**  
**EN55014-2**  
Il prodotto è certificato in accordo alle normative di compatibilità elettromagnetica

**ATTENZIONE!**  
Può essere dannoso ai portatori di pacemakers

### CARATTERISTICHE IDRAULICHE:

Pressione dinamica ottimale 2÷5 bar  
Acqua calda 1/2"  
Acqua fredda 1/2"  
Allaccio sifone con raccordo ø 40 mm

### CARATTERISTICHE ELETTRICHE:

Tensione 220 - 230 V  
Frequenza 50/60 Hz  
Potenza massima assorbita: 2600 W  
Potenza nominale: 2500 W

**ATTENZIONE!** Installare a monte dell'apparecchio un interruttore differenziale da 30mA provvisto di interruttore onnipolare con apertura minima dei contatti ≥ 3 mm.



DISEGNI TECNICI

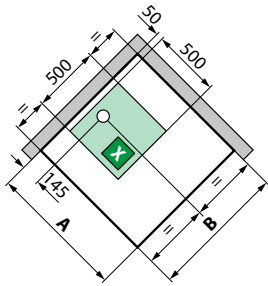
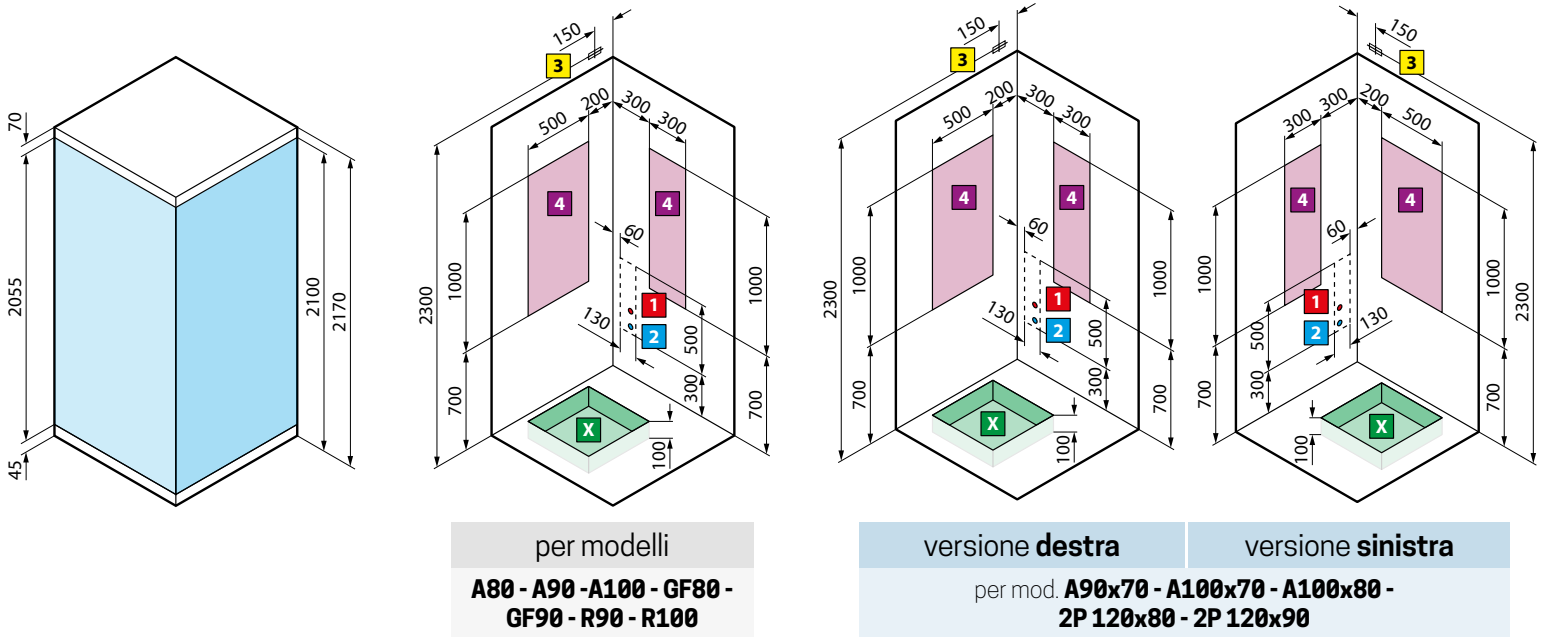

modello	A ± 3	B ± 3
<b>A80</b>	796	796
<b>A90</b>	896	896
<b>A 100</b>	996	996
<b>GF80</b>	796	796
<b>GF90</b>	896	896

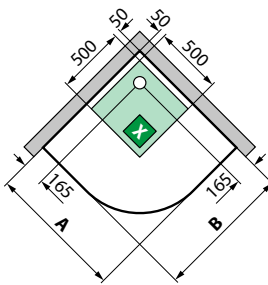

modello	A ± 3	B ± 3
<b>R90</b>	896	896
<b>R100</b>	996	996

### S INSTALLAZIONE A SINISTRA

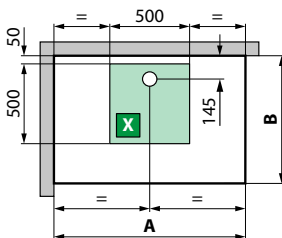

### D INSTALLAZIONE A DESTRA

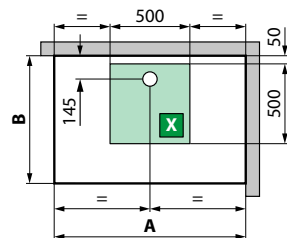

modello	A ± 3	B ± 3
<b>A90x70</b>	896	696
<b>A100x70</b>	996	696
<b>A100x80</b>	996	796
<b>2P120x80</b>	1196	796
<b>2P120x90</b>	1196	896

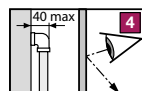
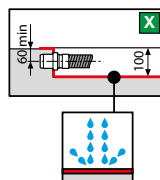
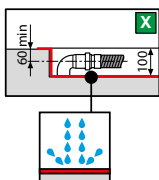

Non ispezionabile



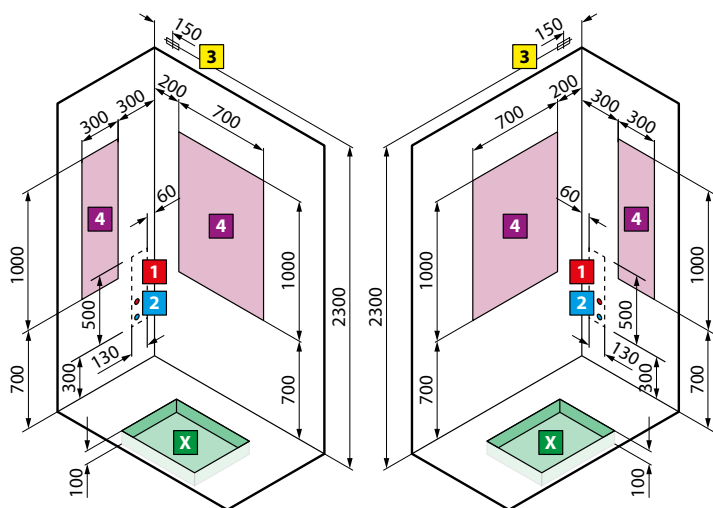

versione **sinistra**

versione **destra**

per mod. **2P140x80 - 2P140x90**

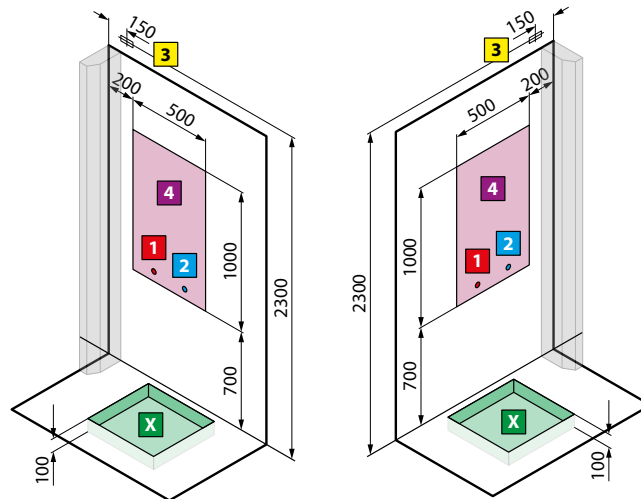

versione **sinistra**

versione **destra**

per mod. **A100x80**

per mod. **A100x80 - 2P120x80**

### S INSTALLAZIONE A SINISTRA

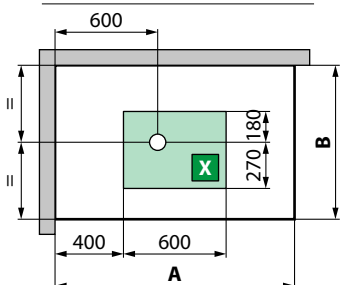

### D INSTALLAZIONE A DESTRA

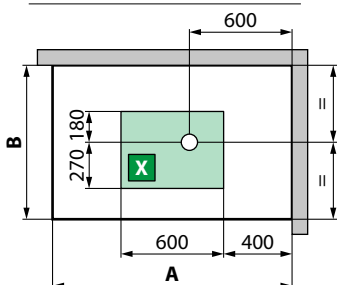

modello	A ± 3	B ± 3
<b>2P140x80</b>	1394	794
<b>2P140x90</b>	1394	894

### S INSTALLAZIONE A SINISTRA

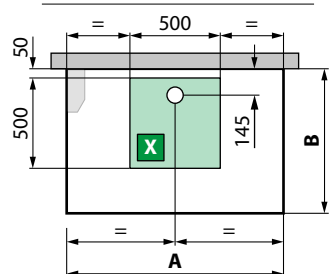

### D INSTALLAZIONE A DESTRA

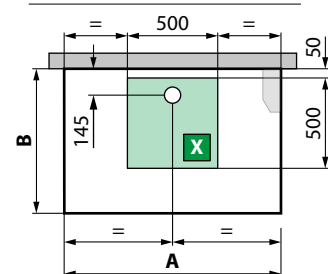

modello	A ± 3	B ± 3
<b>A+F100x80</b>	996	796
<b>2P+2F120x80</b>	1196	796

#### CARATTERISTICHE IDRAULICHE:

Pressione dinamica ottimale 2÷5 bar  
Acqua calda 1/2"  
Acqua fredda 1/2"  
Allaccio sifone con raccordo ø 40 mm

#### CARATTERISTICHE ELETTRICHE:

Tensione 220 - 230 V  
Frequenza 50/60 Hz  
Potenza massima assorbita: 2600 W  
Potenza nominale: 2500 W

**ATTENZIONE!** Installare a monte dell'apparecchio un interruttore differenziale da 30mA provvisto di interruttore onnipolare con apertura minima dei contatti ≥ 3 mm.

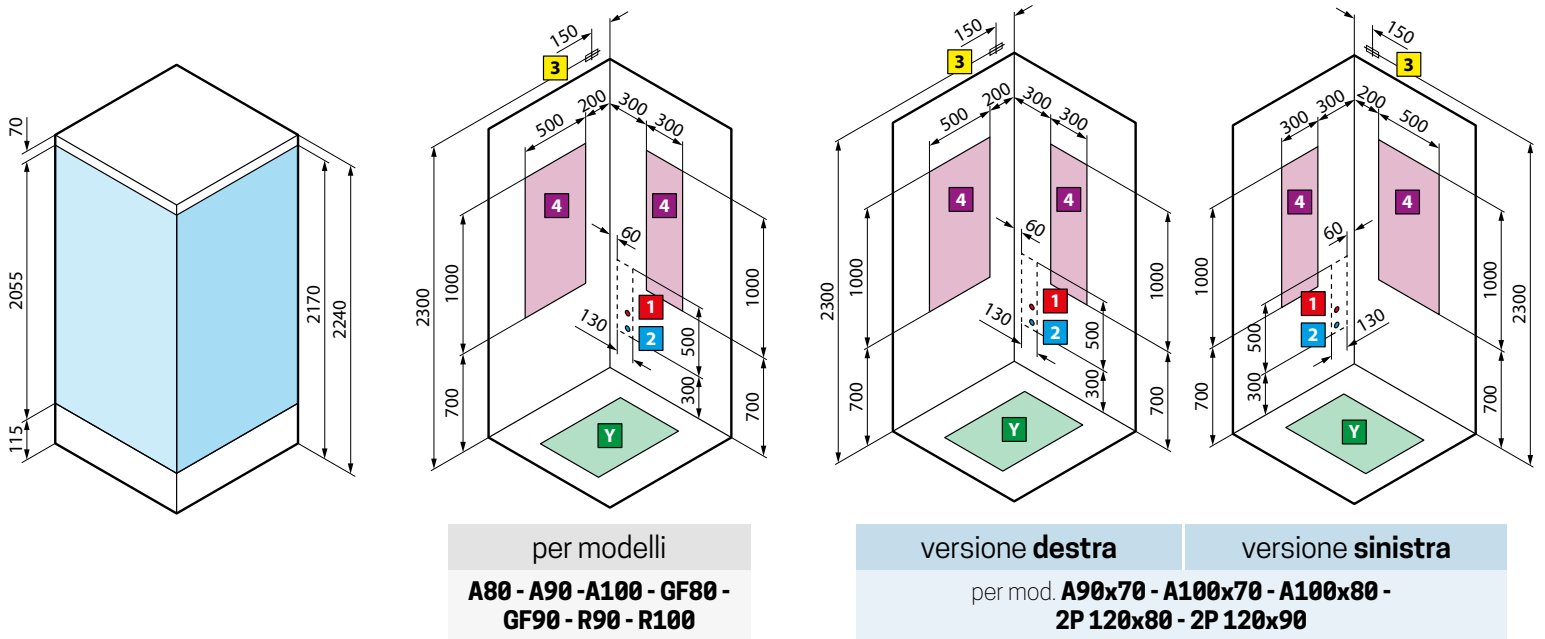

per modelli  
**A80 - A90 - A100 - GF80 - GF90 - R90 - R100**

versione **destra**      versione **sinistra**  
per mod. **A90x70 - A100x70 - A100x80 - 2P120x80 - 2P120x90**

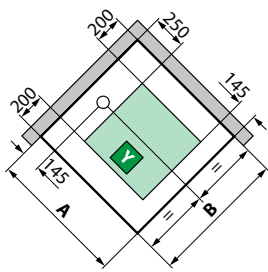

modello	A ± 4	B ± 4
<b>A80</b>	798	798
<b>A90</b>	898	898
<b>A100</b>	998	998
<b>GF80</b>	798	798
<b>GF90</b>	898	898

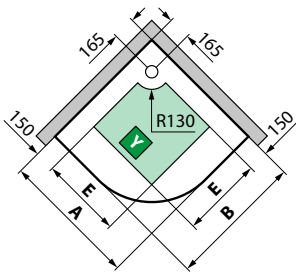

modello	A ± 4	B ± 4	E
<b>R90</b>	898	898	500
<b>R100</b>	998	998	600

### S INSTALLAZIONE A SINISTRA

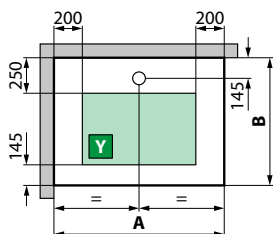

### D INSTALLAZIONE A DESTRA

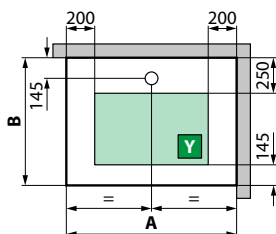

modello	A ± 4	B ± 4
<b>A90x70</b>	898	698
<b>A100x70</b>	998	698
<b>A100x80</b>	998	798
<b>2P120x80</b>	1198	798
<b>2P120x90</b>	1198	898

**ATTENZIONE!**  
Può essere dannoso ai portatori di pacemakers

Non ispezionabile



# GLAX PIATTO 125

# DISEGNI TECNICI

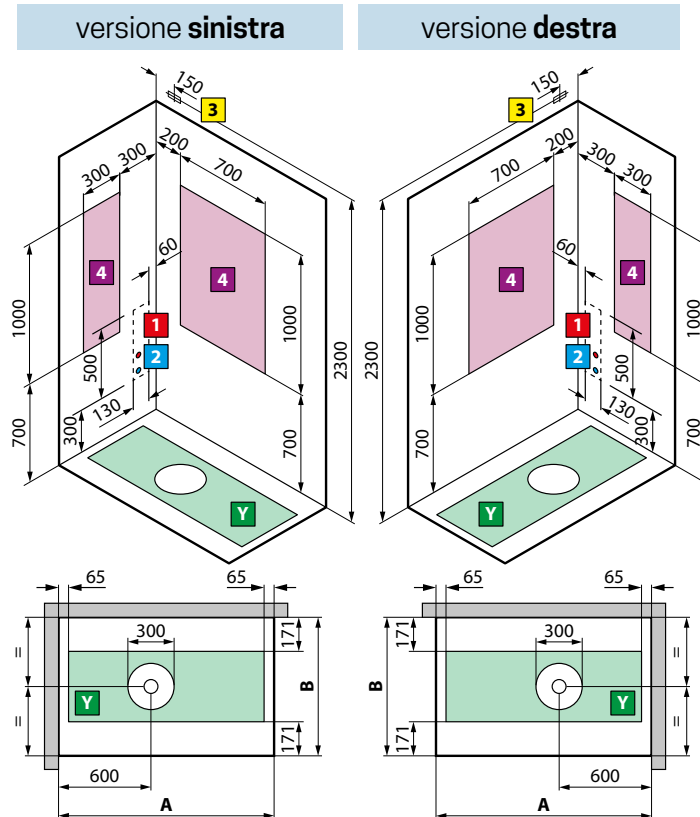
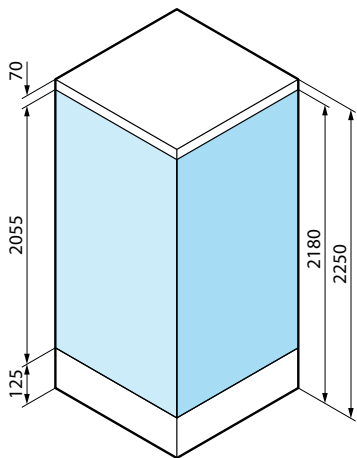

modello	A ± 3	B ± 3
<b>2P140x80</b>	1398	798
<b>2P140x90</b>	1398	898

# GLAX PIATTO 115

# DISEGNI TECNICI

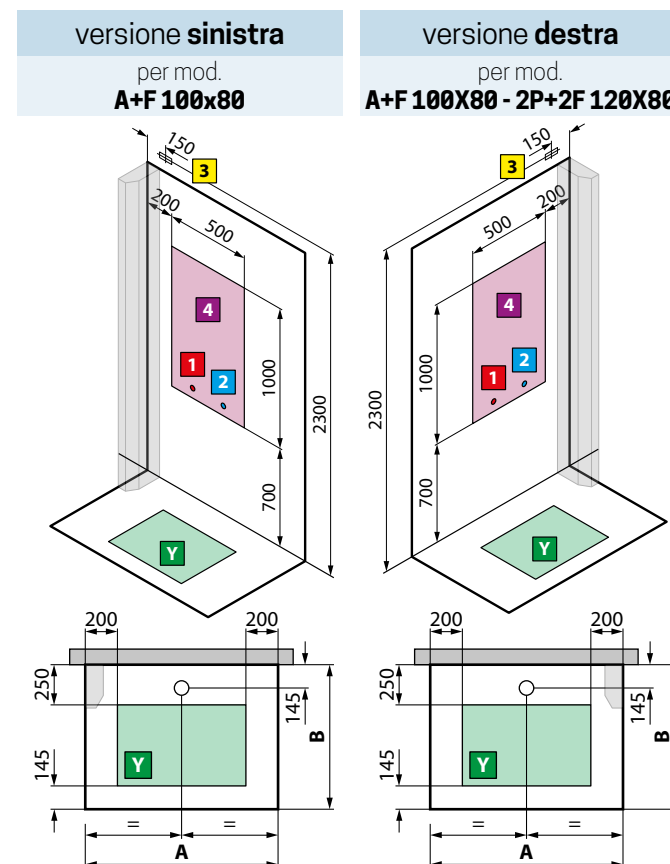
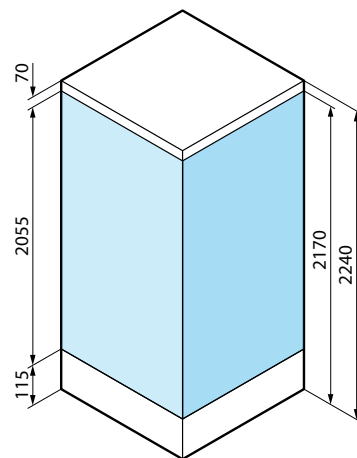

modello	A ± 4	B ± 4
<b>A+F100x80</b>	998	798
<b>2P+2F120x80 *</b>	1198	798

\* disponibile solo per versione destra

**CARATTERISTICHE IDRAULICHE:**  
 Pressione dinamica ottimale 2÷5 bar  
 Acqua calda 1/2"  
 Acqua fredda 1/2"  
 Allaccio sifone con raccordo ø 40 mm

**CARATTERISTICHE ELETTRICHE:**  
 Tensione 220 - 230 V  
 Frequenza 50/60 Hz  
 Potenza massima assorbita: 2600 W  
 Potenza nominale: 2500 W

**ATTENZIONE!** Installare a monte dell'apparecchio un interruttore differenziale da 30mA provvisto di interruttore onnipolare con apertura minima dei contatti ≥ 3 mm.

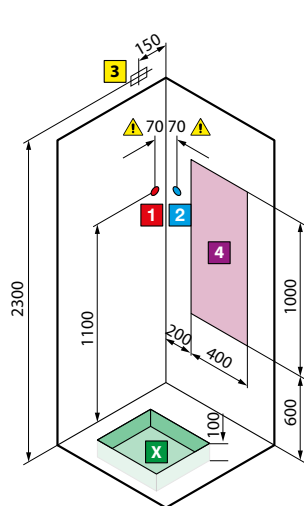
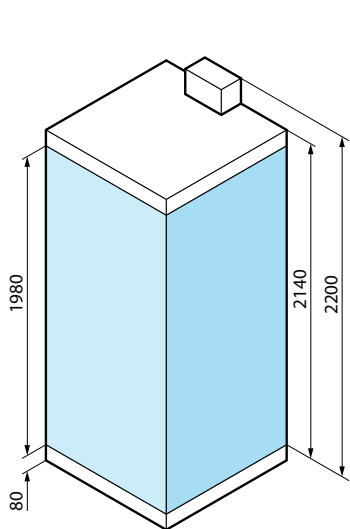

versione **ad angolo**

mod. **A80 - A90 - G90 - R90**

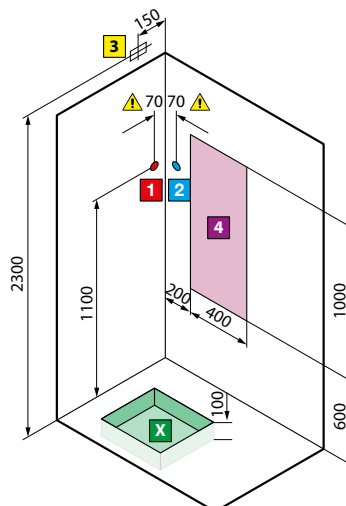

versione **sinistra**

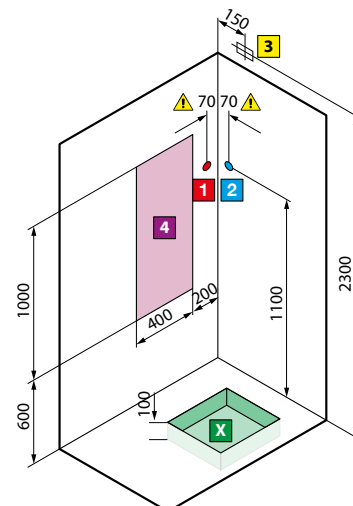

versione **destra**

mod. **A90x70 - A100x70 - A100x80 - 2P120x80**

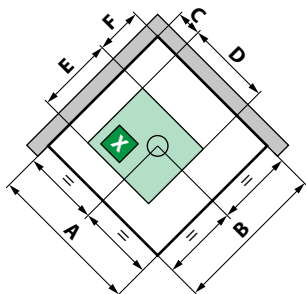

modello	A ± 2	B ± 2	C	D	E	F
<b>A80</b>	800	800	100	500	450	225
<b>A90</b>	900	900	150	500	450	275
<b>G90</b>	900	900	150	500	450	275

### S INSTALLAZIONE A SINISTRA

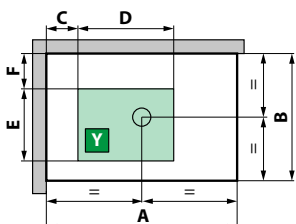

### D INSTALLAZIONE A DESTRA

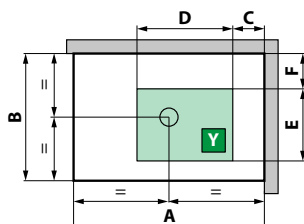

modello	A ± 2	B ± 2	C	D	E	F
<b>A90x70</b>	900	700	150	500	400	200
<b>A100x70</b>	1000	700	200	500	400	200
<b>A100x80</b>	1000	800	200	500	450	220
<b>2P120x80</b>	1200	800	200	600	450	220

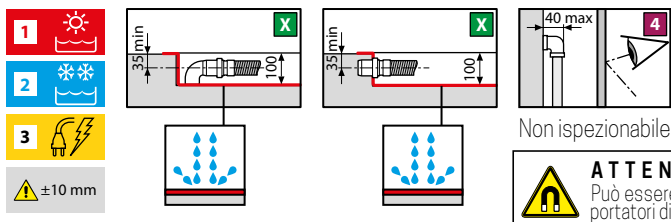

**CARATTERISTICHE IDRAULICHE:**  
 Pressione dinamica ottimale 2÷5 bar  
 Acqua calda 1/2"  
 Acqua fredda 1/2"  
 Allaccio sifone con raccordo ø 40 mm

**CARATTERISTICHE ELETTRICHE:**  
 Tensione 220 - 230 V  
 Frequenza 50/60 Hz  
 Potenza massima assorbita: 2600 W  
 Potenza nominale: 2500 W

**ATTENZIONE!** Installare a monte dell'apparecchio un interruttore differenziale da 30mA provvisto di interruttore onnipolare con apertura minima dei contatti ≥ 3 mm.

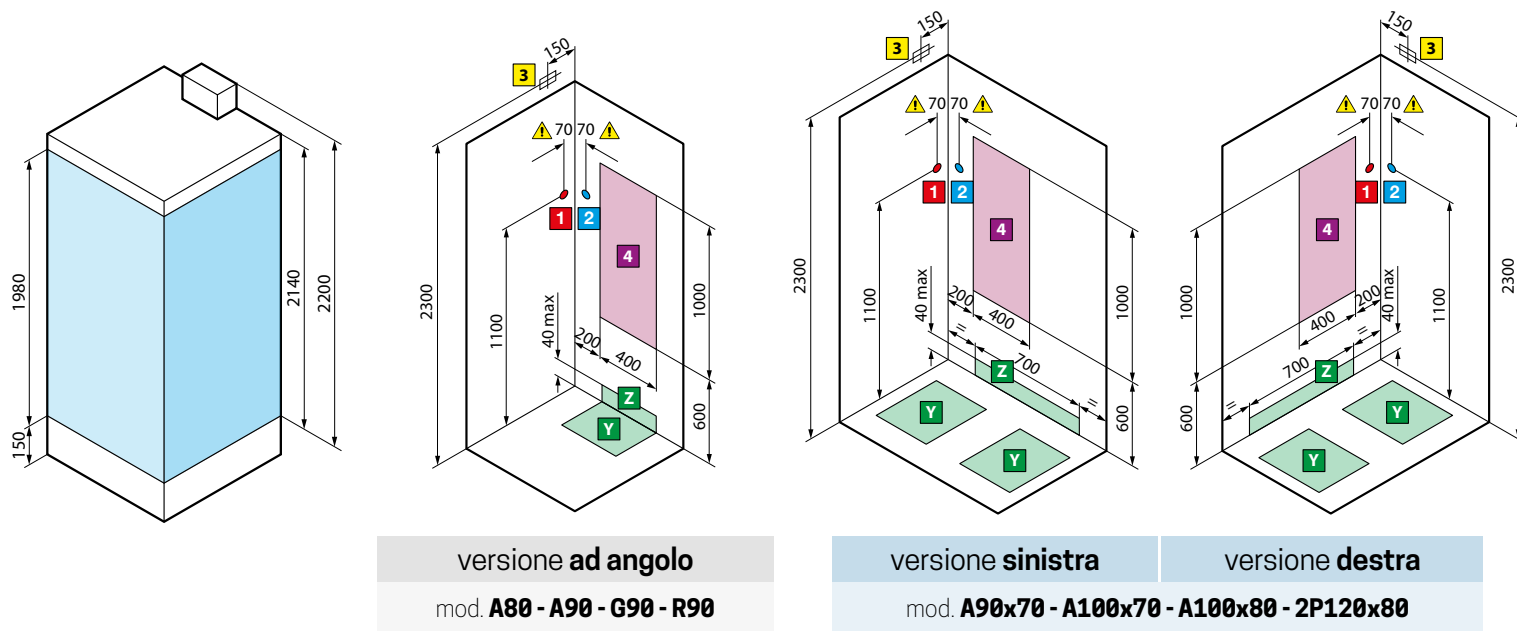

versione **ad angolo**  
mod. **A80 - A90 - G90 - R90**

versione **sinistra**      versione **destra**  
mod. **A90x70 - A100x70 - A100x80 - 2P120x80**

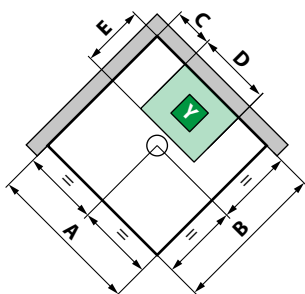

modello	A ± 4	B ± 4	C	D	E
<b>A80</b>	800	800	200	400	300
<b>A90</b>	900	900	200	500	300
<b>G90</b>	900	900	200	500	300

DISEGNI TECNICI

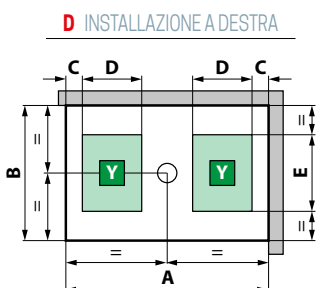
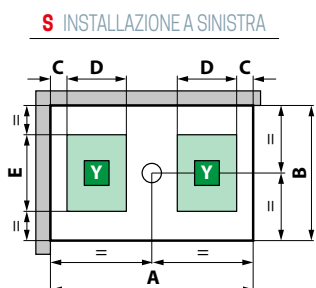

modello	A ± 4	B ± 4	C	D	E
<b>A90x70</b>	900	700	50	250	350
<b>A100x70</b>	1000	700	100	250	350
<b>A100x80</b>	1000	800	100	250	450
<b>2P120x80</b>	1200	800	100	350	450

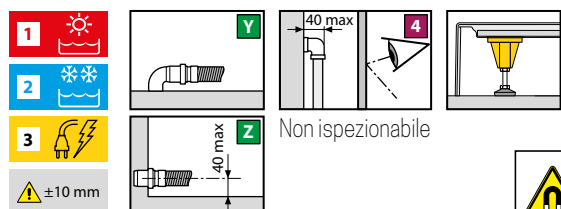

Non ispezionabile

**ATTENZIONE!**  
Può essere dannoso ai portatori di pacemakers

**CARATTERISTICHE IDRAULICHE:**  
Pressione dinamica ottimale 2÷5 bar  
Acqua calda 1/2"  
Acqua fredda 1/2"  
Allaccio sifone con raccordo ø 40 mm

**CARATTERISTICHE ELETTRICHE:**  
Tensione 220 - 230 V  
Frequenza 50/60 Hz  
Potenza massima assorbita: 2600 W  
Potenza nominale: 2500 W

**ATTENZIONE!** Installare a monte dell'apparecchio un interruttore differenziale da 30mA provvisto di interruttore onnipolare con apertura minima dei contatti ≥ 3 mm.

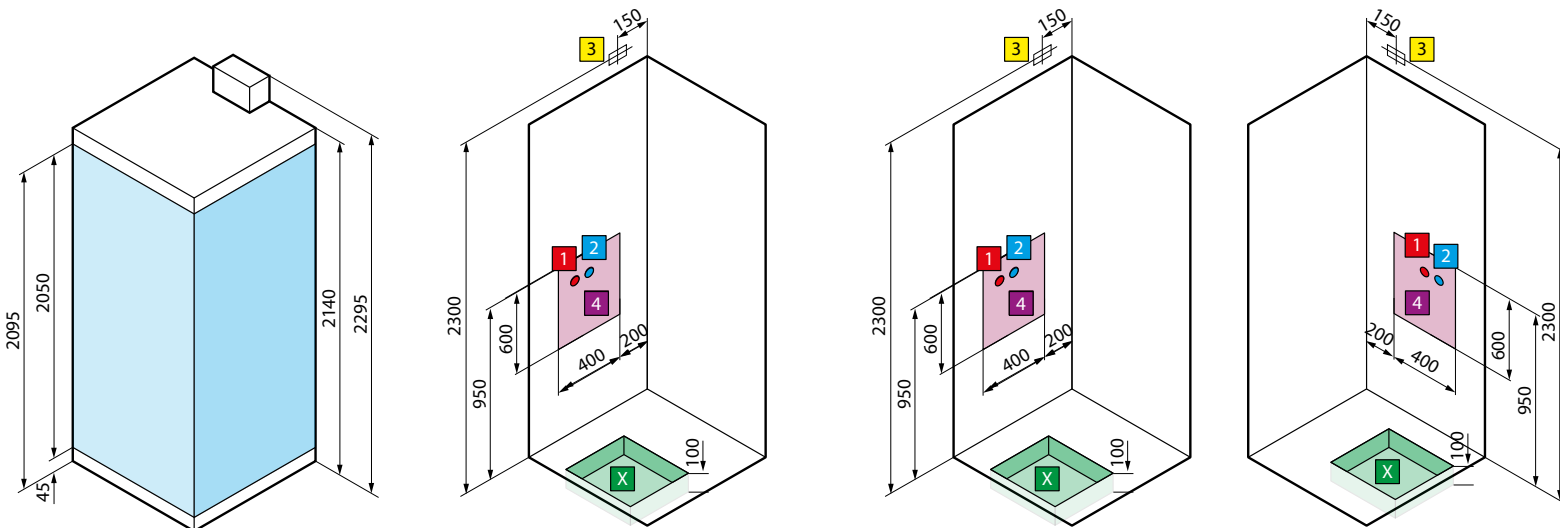

per modelli  
**GF/A80 - GF/A90 - G90 - R90 - 2P120**

versione **sinistra**      versione **destra**  
per modelli **A100x80 - 2P120x80 - 2P120x90**

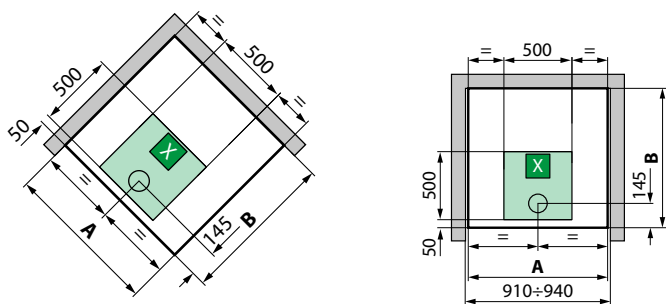

modello	A ± 4	B ± 4
<b>GF/A80</b>	802	802
<b>GF/A90</b>	902	902
<b>G90</b>	902	902

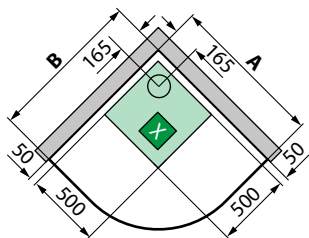

modello	A ± 4	B ± 4
<b>R90</b>	902	902

## S INSTALLAZIONE A SINISTRA

## D INSTALLAZIONE A DESTRA

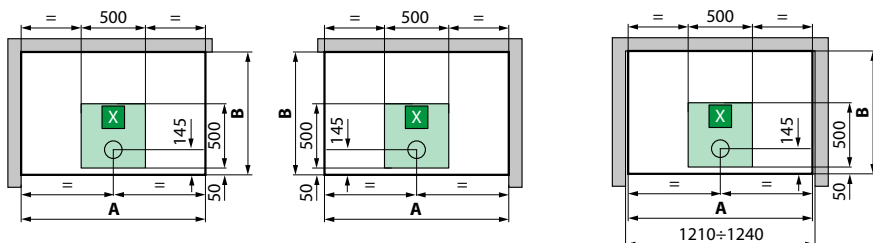

modello	A ± 4	B ± 4
<b>A100x80</b>	1002	802
<b>2P120x80</b>	1202	802
<b>2P120x90</b>	1202	902

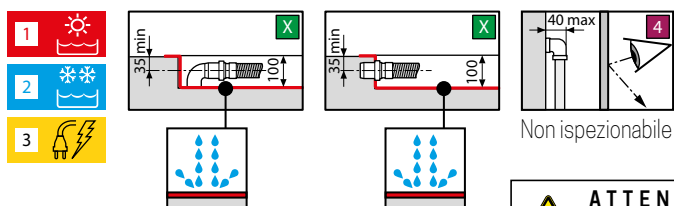

**ATTENZIONE!**  
Può essere dannoso ai portatori di pacemakers

**CARATTERISTICHE IDRAULICHE:**  
Pressione dinamica ottimale 2÷5 bar  
Acqua calda 1/2"  
Acqua fredda 1/2"  
Allaccio sifone con raccordo ø 40 mm

**CARATTERISTICHE ELETTRICHE:**  
Tensione 220 - 230 V  
Frequenza 50/60 Hz  
Potenza nominale: 2500 W  
Potenza massima HAMMAM: 2600 W  
Potenza massima BASE e IDRO: 50 W

**ATTENZIONE!** Installare a monte dell'apparecchio un interruttore differenziale da 30mA provvisto di interruttore onnipolare con apertura minima dei contatti ≥ 3 mm.

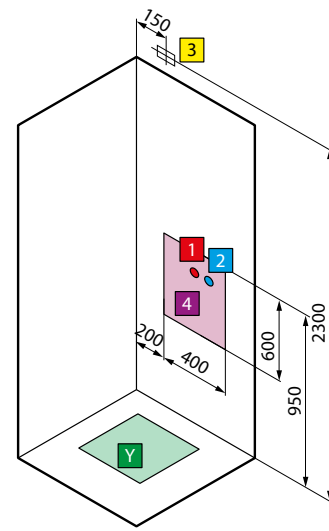
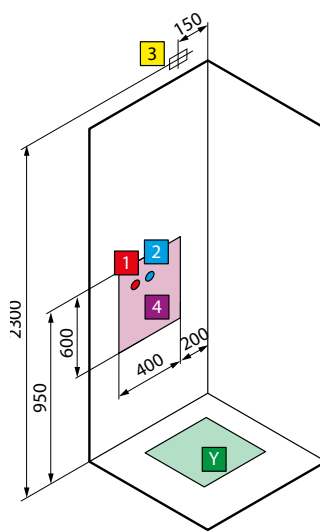
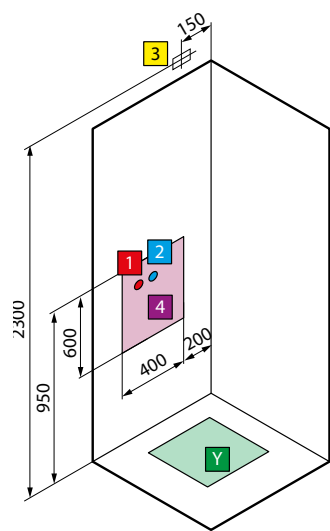
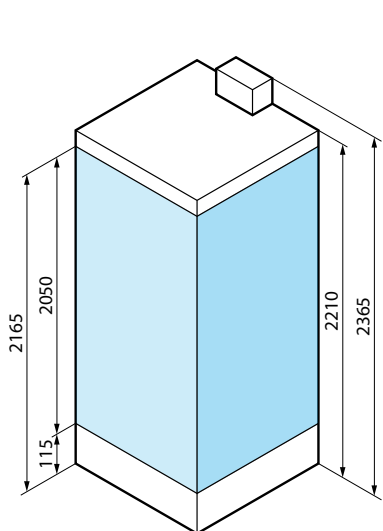

per modelli  
**GF/A80 - GF/A90 - G90 - R90 - 2P120**

versione **sinistra** | versione **destra**  
per modelli **A100x80 - 2P120x80 - 2P120x90**

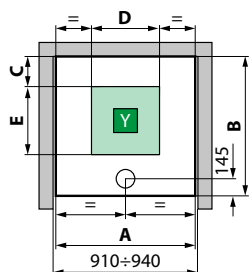
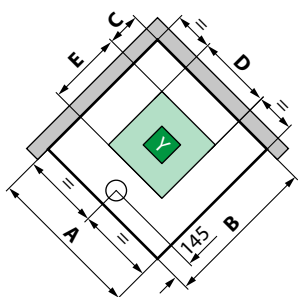

modello	A ± 4	B ± 4	C	D	E
<b>GF/A80</b>	802	802	150	400	400
<b>GF/A90</b>	902	902	150	500	500
<b>G90</b>	902	902	150	500	500

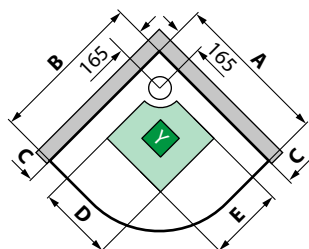

modello	A ± 4	B ± 4	C	D	E
<b>R90</b>	902 ± 4	902	156	500	500

### S INSTALLAZIONE A SINISTRA

### D INSTALLAZIONE A DESTRA

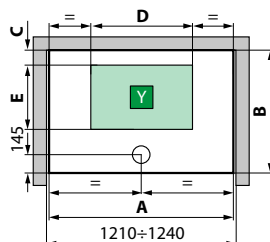
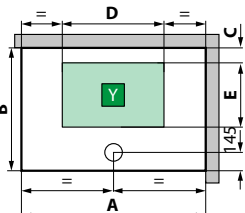
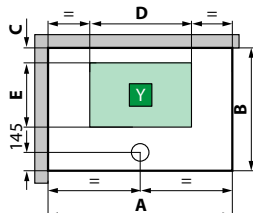

modello	A ± 4	B ± 4	C	D	E
<b>A100x80</b>	1002	802	150	600	400
<b>2P120x80</b>	1202	802	150	800	400
<b>2P120x90</b>	1202	902	150	800	500

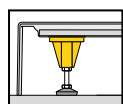
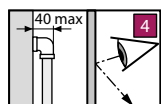
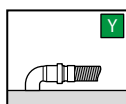
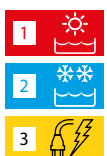

Non ispezionabile



### CARATTERISTICHE IDRAULICHE:

Pressione dinamica ottimale 2-5 bar  
Acqua calda 1/2"  
Acqua fredda 1/2"  
Allaccio sifone con raccordo ø 40 mm

### CARATTERISTICHE ELETTRICHE:

Tensione 220 - 230 V  
Frequenza 50/60 Hz  
Potenza nominale: 2500 W  
Potenza massima HAMMAM: 2600 W  
Potenza massima BASE e IDRO: 50 W

**ATTENZIONE!** Installare a monte dell'apparecchio un interruttore differenziale da 30mA provvisto di interruttore onnipolare con apertura minima dei contatti ≥ 3 mm.

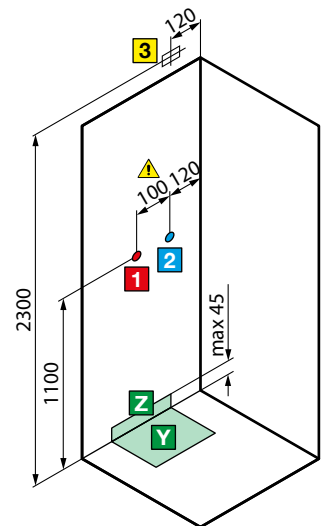
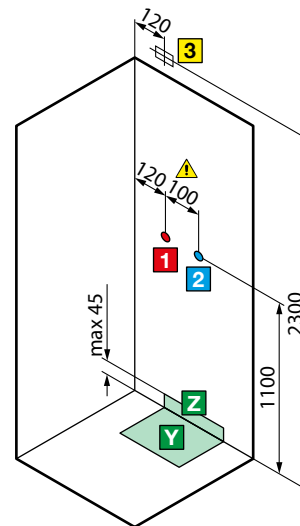
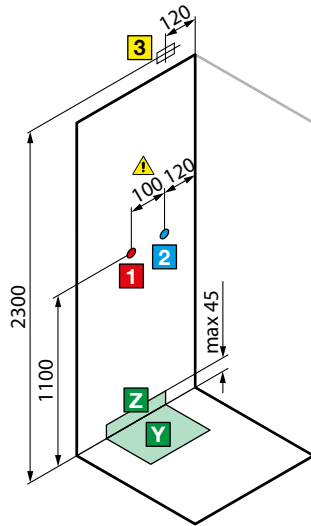
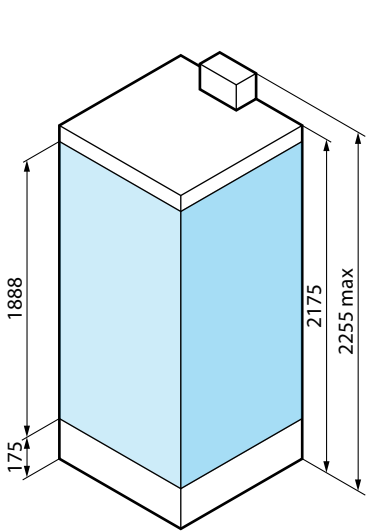

per i modelli  
**A90 - GF90 - S2F**

versione **sinistra**      versione **destra**  
per modelli **A80 - GF80 - 2P100x70 - 2P120x80 - SF100x80**

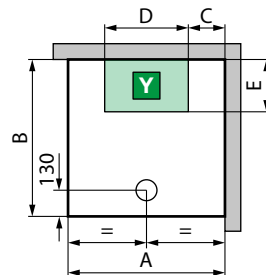
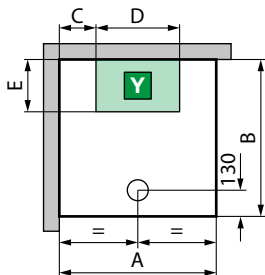

Solo per modello  
**S2F100**

modello	A ± 5	B ± 5	C	D	E
<b>A80</b>	804	804	200	404	300
<b>A90</b>	904	904	200	504	300
<b>GF80</b>	804	804	200	404	300
<b>GF90</b>	904	904	200	504	300

**S** INSTALLAZIONE A SINISTRA

**D** INSTALLAZIONE A DESTRA

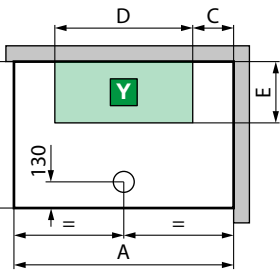
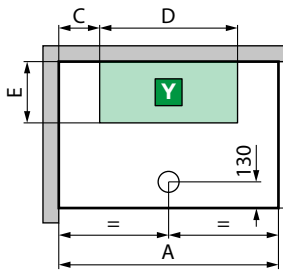

modello	A ± 5	B ± 5	C	D	E
<b>2P100x70</b>	1004	704	200	604	300
<b>2P120x80</b>	1204	804	200	804	300
<b>SF100x80</b>	1004	804	200	604	300

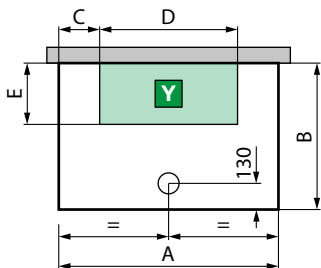

modello	A ± 5	B ± 5	C	D	E
<b>S2F</b>	1004	804	200	604	300

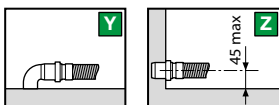

**ATTENZIONE!**  
Può essere dannoso ai portatori di pacemakers

**CARATTERISTICHE IDRAULICHE:**  
Pressione dinamica ottimale 2÷5 bar  
Acqua calda 1/2"  
Acqua fredda 1/2"  
Allaccio sifone con raccordo ø 40 mm

**CARATTERISTICHE ELETTRICHE:**  
Tensione 220 - 230 V  
Frequenza 50/60 Hz  
Potenza massima assorbita: 2600 W  
Potenza nominale: 2500 W

**ATTENZIONE!** Installare a monte dell'apparecchio un interruttore differenziale da 30mA provvisto di interruttore onnipolare con apertura minima dei contatti ≥ 3 mm.

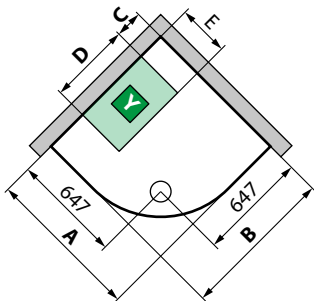
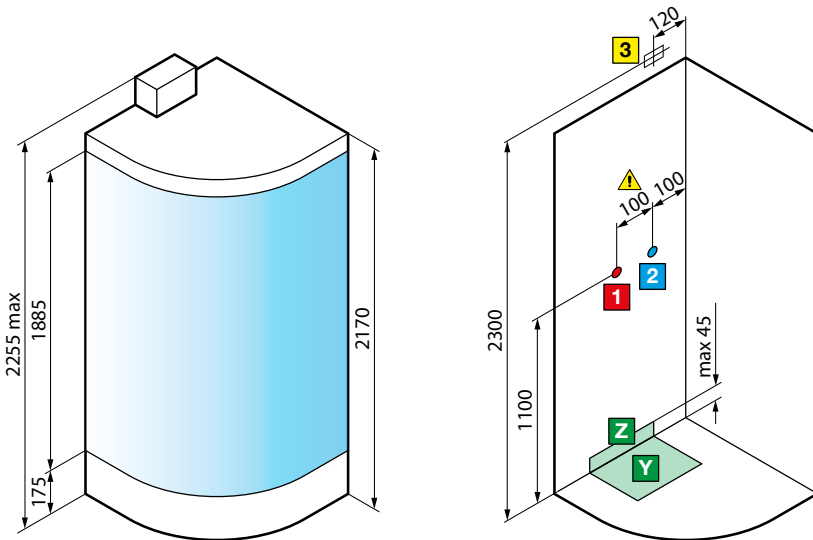

MOD. R90

mod.	A ±5	B ±5	C	D	E
R90	904	904	200	504	300

DISEGNI TECNICI

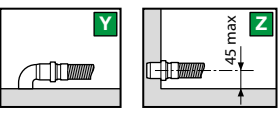

**ATTENZIONE!**  
Può essere dannoso ai portatori di pacemakers

**CARATTERISTICHE IDRAULICHE:**  
Pressione dinamica ottimale 2-5 bar  
Acqua calda 1/2"  
Acqua fredda 1/2"  
Allaccio sifone con raccordo ø 40 mm

**CARATTERISTICHE ELETTRICHE:**  
Tensione 220 - 230 V  
Frequenza 50/60 Hz  
Potenza massima assorbita: 2600 W  
Potenza nominale: 2500 W

**ATTENZIONE!** Installare a monte dell'apparecchio un interruttore differenziale da 30mA provvisto di interruttore onnipolare con apertura minima dei contatti ≥ 3 mm.

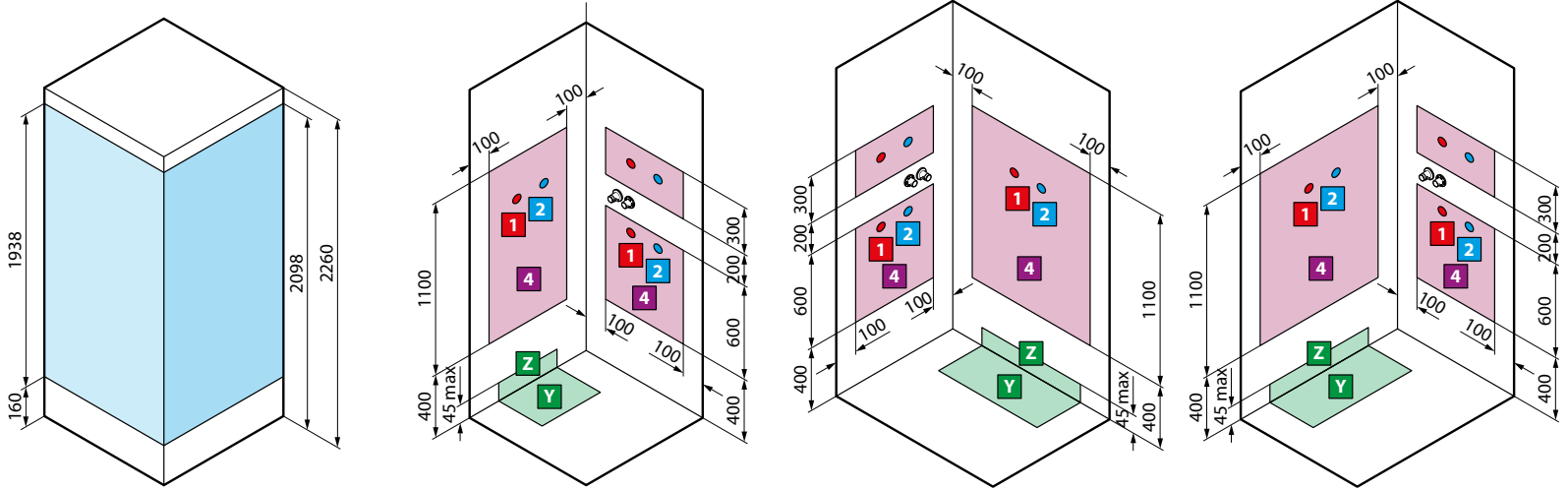

per modelli  
**A80 - A90 - R90 - GF80 - GF90**

versione **sinistra**      versione **destra**  
per modelli **A 90x70 - A 100x70 - A 100x80 - 2P 120x80**

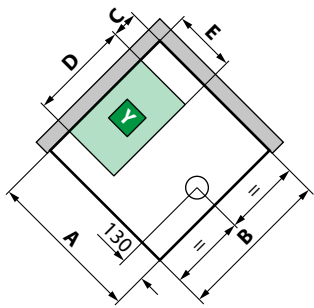

modello	A ± 5	B ± 5	C	D	E
<b>A80</b>	804	804	200	404	300
<b>A90</b>	904	904	200	504	300
<b>GF80</b>	804	804	200	404	300
<b>GF90</b>	904	904	200	504	300

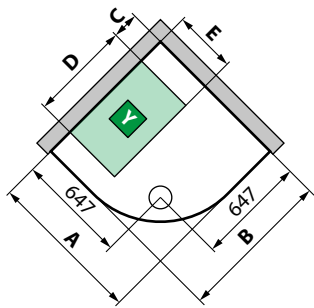

modello	A ± 5	B ± 5	C	D	E
<b>R90</b>	904	904	200	504	300

**S** INSTALLAZIONE A SINISTRA

**D** INSTALLAZIONE A DESTRA

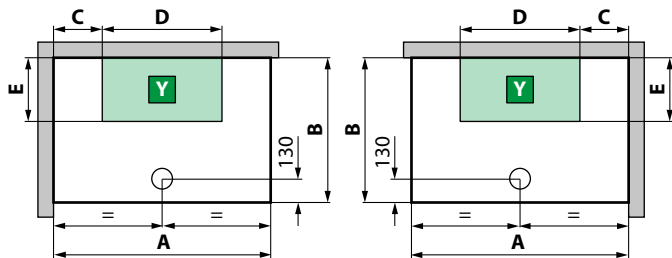

modello	A ± 5	B ± 5	C	D	E
<b>A90x70</b>	904	704	200	504	300
<b>A100x70</b>	1004	704	200	604	300
<b>A100x80</b>	1004	804	200	604	300
<b>2P120x80</b>	1204	804	200	804	300

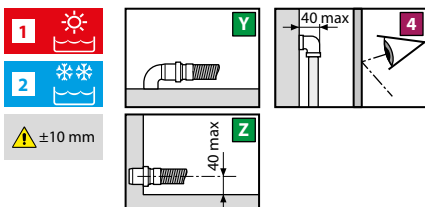

**CARATTERISTICHE IDRAULICHE:**

Pressione dinamica ottimale 2÷5 bar  
Acqua calda 1/2"  
Acqua fredda 1/2"  
Allaccio sifone con raccordo ø 40 mm



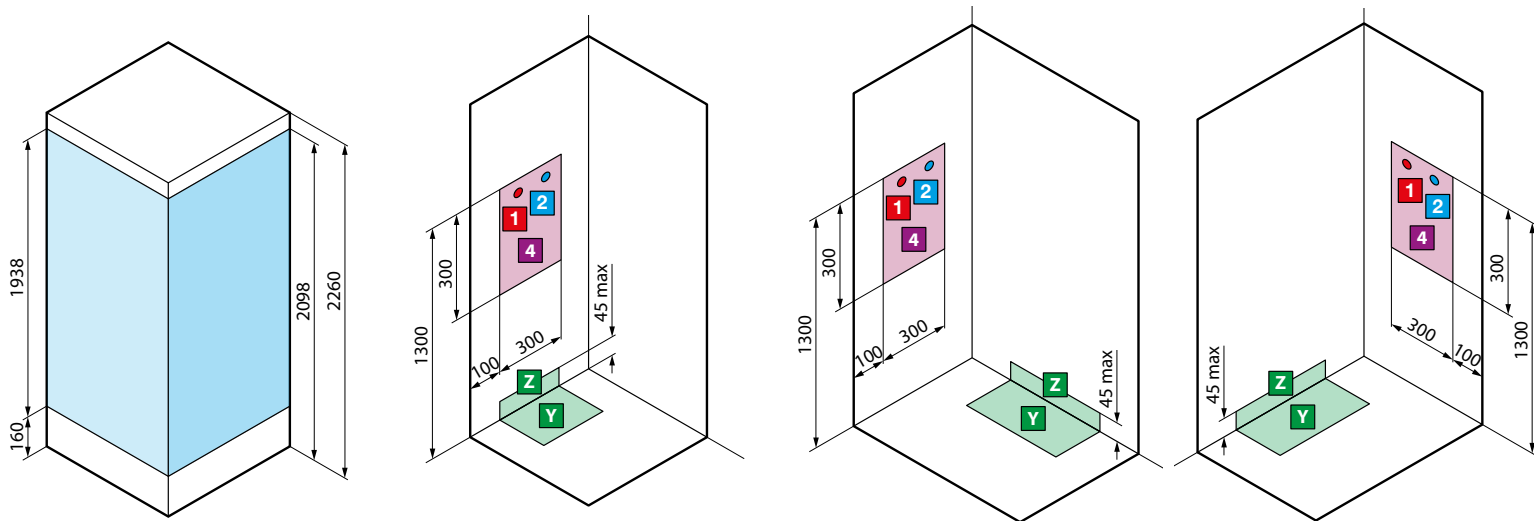

per modelli  
**A80 - A90 - R90 - GF80 - GF90**

versione **sinistra**      versione **destra**  
per modelli **A 90x70 - A 100x70 - A 100x80 - 2P 120x80**

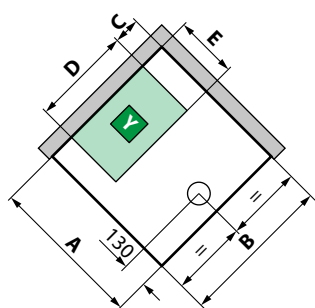

modello	A ± 5	B ± 5	C	D	E
<b>A80</b>	804	804	200	404	300
<b>A90</b>	904	904	200	504	300
<b>GF80</b>	804	804	200	404	300
<b>GF90</b>	904	904	200	504	300

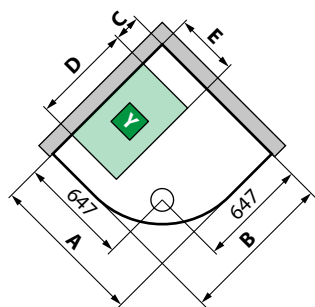

modello	A ± 5	B ± 5	C	D	E
<b>R90</b>	904	904	200	504	300

**S** INSTALLAZIONE A SINISTRA

**D** INSTALLAZIONE A DESTRA

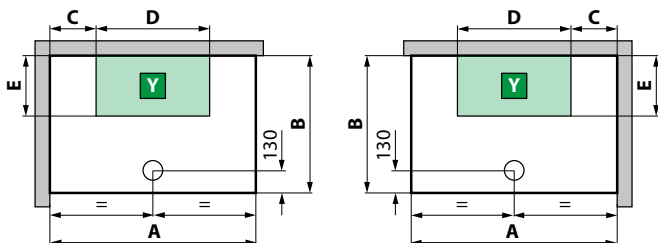

modello	A ± 5	B ± 5	C	D	E
<b>A90x70</b>	904	704	200	504	300
<b>A100x70</b>	1004	704	200	604	300
<b>A100x80</b>	1004	804	200	604	300
<b>2P120x80</b>	1204	804	200	804	300

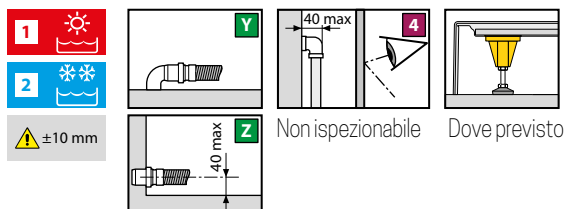

**CARATTERISTICHE IDRAULICHE:**  
 Pressione dinamica ottimale 2÷5 bar  
 Acqua calda 1/2"  
 Acqua fredda 1/2"  
 Allaccio sifone con raccordo ø 40 mm

# REVOLUTION

**HAI BISOGNO DI RIORGANIZZARE IL TUO BAGNO O SEMPLICEMENTE RINNOVARLO?**

*REVOLUTION È LA SOLUZIONE PIÙ ADATTA ALLE TUE ESIGENZE. GRAZIE ALLE MOLTEPLICI MISURE E SOLUZIONI, È LA CABINA DOCCIA IDEALE PER LE RISTRUTTURAZIONI E PERFETTA PER LA SOSTITUZIONE DELLA VASCA.*

## Pratica

Facile e veloce da installare, anche senza lavori di muratura. La migliore soluzione per la sostituzione di una vecchia vasca o cabina doccia.

## Sicurezza e solidità

La garanzia tecnica di un progetto sviluppato dall'ufficio sviluppo di una grande azienda.

## Diverse proposte di configurazione

Massima funzionalità per il tuo bagno.  
Massima opportunità di configurazione per un bagno elegante e coordinato.

### TRATTAMENTI



Una **cabina con box doccia**



Una **cabina con spazio doccia**



Una **cabina doccia con colonna multifunzione**



Una **cabina doccia con colonna porta-lavatrice e porta-biancheria**



REVOLUTION

Una **cabina doccia** con **colonna porta-lavatrice e asciugatrice**

# REVOLUTION

# COME PERSONALIZZARE LA TUA REVOLUTION IN 4 MOSSE



<b>1</b> PIATTO DOCCIA p. 459		COD.
	ZEPHYROS 2P	COD.
<b>2</b> BOX DOCCIA p. 460	ZEPHYROS 2A	COD.
	ZEPHYROS F	COD.
	GIADA H1	COD.
<b>2</b> SPAZIO DOCCIA p. 462	GIADA H2	COD.
	GIADA HA	COD.
		COD.
<b>3</b> PANNELLI A MURO p. 463	COLONNA	COD.
	SEDILE	COD.
	SPECCHIO	COD.
	POGGIAPIEDI	COD.
	MANIGLIONE	COD.
	SCATOLA PER ALLACCI IDRAULICI	COD.
<b>4</b> ACCESSORI p. 464		

## 1 PIATTO DOCCIA - OLYMPIC PLUS

**SPESSORE 4,5 CM**

con antiscivolo (PN24)

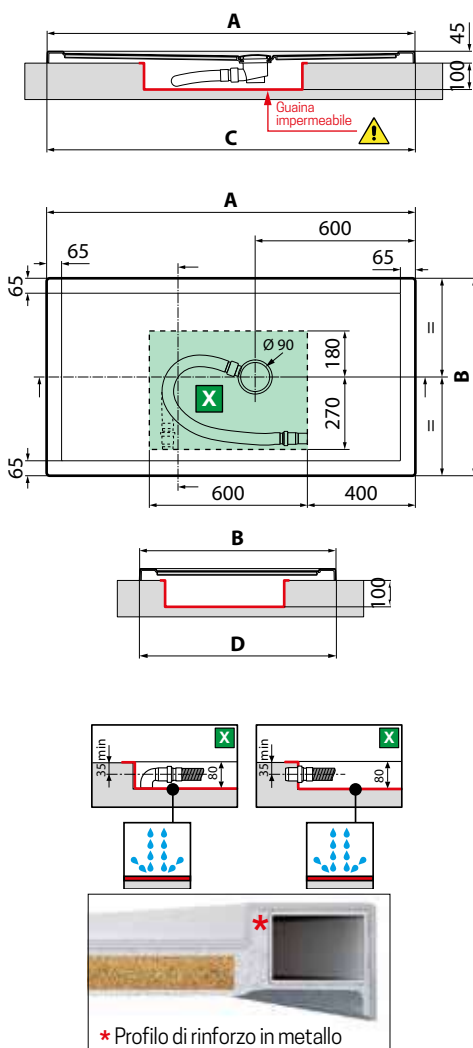

Misure	Codice	Scelta finitura / Prezzo						Codice	Prezzo	
		30	79	11	27	29	28			
		Bianco	Bianco morbido	Beige	Corda	Grigio	Nero		Bianco	
<b>AxB * ± 2 mm</b>	<b>CxD ** ± 3 mm</b>									
120 x 70	1194 x 692	1196 x 694	<b>OL120704-</b>	277 €	442 €	468 €	468 €	468 €	<b>OL120704A-</b>	409 €
120 x 80	1194 x 792	1196 x 794	<b>OL801204-</b>	283 €	448 €	477 €	477 €	477 €	<b>OL801204A-</b>	415 €
120 x 90	1194 x 892	1196 x 894	<b>OL120904-</b>	305 €	470 €	500 €	500 €	500 €	<b>OL120904A-</b>	438 €
120 x 100	1194 x 992	1196 x 994	<b>OL120104-</b>	324 €	489 €	519 €	519 €	519 €	<b>OL120104A-</b>	457 €
140 x 70	1392 x 692	1394 x 694	<b>OL140704-</b>	297 €	463 €	490 €	490 €	490 €	<b>OL140704A-</b>	429 €
140 x 75	1392 x 742	1394 x 744	<b>OL140754-</b>	297 €	463 €	490 €	490 €	490 €	<b>OL140754A-</b>	429 €
140 x 80	1392 x 792	1394 x 794	<b>OL140804-</b>	322 €	487 €	515 €	515 €	515 €	<b>OL140804A-</b>	454 €
140 x 90	1392 x 892	1394 x 894	<b>OL140904-</b>	353 €	518 €	549 €	549 €	549 €	<b>OL140904A-</b>	485 €
140 x 100	1392 x 992	1394 x 994	<b>OL140104-</b>	368 €	533 €	565 €	565 €	565 €	<b>OL140104A-</b>	500 €
160 x 70	1592 x 692	1594 x 694	<b>OL160704-</b>	327 €	492 €	523 €	523 €	523 €	<b>OL160704A-</b>	459 €
160 x 75	1592 x 742	1594 x 744	<b>OL160754-</b>	334 €	500 €	530 €	530 €	530 €	<b>OL160754A-</b>	467 €
160 x 80	1592 x 792	1594 x 794	<b>OL160804-</b>	369 €	534 €	567 €	567 €	567 €	<b>OL160804A-</b>	502 €
160 x 90	1592 x 892	1594 x 894	<b>OL160904-</b>	377 €	543 €	577 €	577 €	577 €	<b>OL160904A-</b>	509 €
170 x 70	1692 x 692	1694 x 694	<b>OL170704-</b>	338 €	504 €	534 €	534 €	534 €	<b>OL170704A-</b>	470 €
170 x 75	1692 x 742	1694 x 744	<b>OL170754-</b>	364 €	529 €	562 €	562 €	562 €	<b>OL170754A-</b>	497 €
170 x 80	1692 x 792	1694 x 794	<b>OL170804-</b>	374 €	540 €	574 €	574 €	574 €	<b>OL170804A-</b>	507 €
170 x 90	1692 x 892	1694 x 894	<b>OL170904-</b>	398 €	563 €	597 €	597 €	597 €	<b>OL170904A-</b>	530 €
180 x 75	1792 x 742	1794 x 744	<b>OL180754-</b>	379 €	545 €	579 €	579 €	579 €	<b>OL180754A-</b>	512 €
180 x 80	1792 x 792	1794 x 794	<b>OL180804-</b>	400 €	565 €	599 €	599 €	599 €	<b>OL180804A-</b>	533 €
180 x 90	1792 x 892	1794 x 894	<b>OL180904-</b>	423 €	588 €	624 €	624 €	624 €		

**SPESSORE 12,5 CM**

con antiscivolo (PN24)

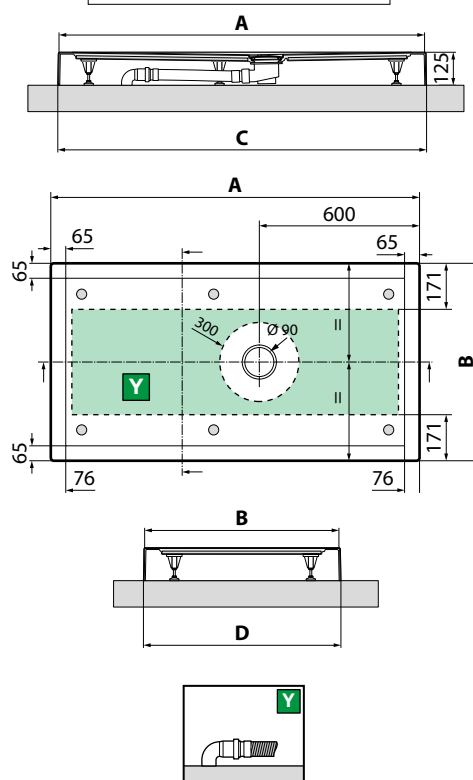

Misure	Codice	Scelta finitura / Prezzo						Codice	Prezzo	
		30	79	11	27	29	28			
		Bianco	Bianco morbido	Beige	Corda	Grigio	Nero		Bianco	
<b>AxB * ± 2 mm</b>	<b>CxD ** ± 3 mm</b>									
120 x 70	1194 x 692	1200 x 698	<b>OL1207011-</b>	277 €	442 €	468 €	468 €	468 €	<b>OL1207011A-</b>	409 €
120 x 80	1194 x 792	1200 x 798	<b>OL8012011-</b>	283 €	448 €	477 €	477 €	477 €	<b>OL8012011A-</b>	415 €
120 x 90	1194 x 892	1200 x 898	<b>OL1209011-</b>	305 €	470 €	500 €	500 €	500 €	<b>OL1209011A-</b>	438 €
120 x 100	1194 x 992	1200 x 998	<b>OL1201011-</b>	324 €	489 €	519 €	519 €	519 €	<b>OL1201011A-</b>	457 €
140 x 70	1392 x 692	1398 x 698	<b>OL1407011-</b>	297 €	463 €	490 €	490 €	490 €	<b>OL1407011A-</b>	429 €
140 x 75	1392 x 742	1398 x 748	<b>OL1407511-</b>	297 €	463 €	490 €	490 €	490 €	<b>OL1407511A-</b>	429 €
140 x 80	1392 x 792	1398 x 798	<b>OL1408011-</b>	322 €	487 €	515 €	515 €	515 €	<b>OL1408011A-</b>	454 €
140 x 90	1392 x 892	1398 x 898	<b>OL1409011-</b>	353 €	518 €	549 €	549 €	549 €	<b>OL1409011A-</b>	485 €
140 x 100	1392 x 992	1398 x 998	<b>OL1401011-</b>	368 €	533 €	565 €	565 €	565 €	<b>OL1401011A-</b>	500 €
160 x 70	1592 x 692	1598 x 698	<b>OL1607011-</b>	327 €	492 €	523 €	523 €	523 €	<b>OL1607011A-</b>	459 €
160 x 75	1592 x 742	1598 x 748	<b>OL1607511-</b>	334 €	500 €	530 €	530 €	530 €	<b>OL1607511A-</b>	467 €
160 x 80	1592 x 792	1598 x 798	<b>OL1608011-</b>	369 €	534 €	567 €	567 €	567 €	<b>OL1608011A-</b>	502 €
160 x 90	1592 x 892	1598 x 898	<b>OL1609011-</b>	377 €	543 €	577 €	577 €	577 €	<b>OL1609011A-</b>	509 €
170 x 70	1692 x 692	1698 x 698	<b>OL1707011-</b>	338 €	504 €	534 €	534 €	534 €	<b>OL1707011A-</b>	470 €
170 x 75	1692 x 742	1698 x 748	<b>OL1707511-</b>	364 €	529 €	562 €	562 €	562 €	<b>OL1707511A-</b>	497 €
170 x 80	1692 x 792	1698 x 798	<b>OL1708011-</b>	374 €	540 €	574 €	574 €	574 €	<b>OL1708011A-</b>	507 €
170 x 90	1692 x 892	1698 x 898	<b>OL1709011-</b>	398 €	563 €	597 €	597 €	597 €	<b>OL1709011A-</b>	530 €
180 x 75	1792 x 742	1798 x 748	<b>OL1807511-</b>	379 €	545 €	579 €	579 €	579 €	<b>OL1807511A-</b>	512 €
180 x 80	1792 x 792	1798 x 798	<b>OL1808011-</b>	400 €	565 €	599 €	599 €	599 €	<b>OL1808011A-</b>	533 €
180 x 90	1792 x 892	1798 x 898	<b>OL1809011-</b>	423 €	588 €	624 €	624 €	624 €		

**X** Zona incassata a pavimento per lo scarico H 100

**Y** Zona disponibile per lo scarico sopra pavimento

## 2 BOX DOCCIA



### PORTE

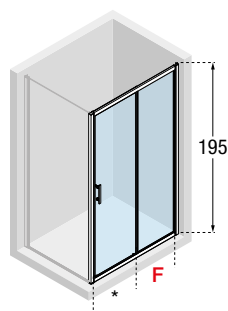

Reversibile

**ZEPHYROS 2P** Installabile in nicchia, con fisso laterale o centro parete

Misure				Codice	Scelta vetro				Scelta Profilo /Prezzo			
Larghezza piatto	Estensibilità	Fisso	Entrata (cm)		1	68	11	54	A	B	K	H
		<b>F</b>	<b>*</b>		Trasparente	Serigrafia Zephyros 1	Niva	Fumè	Bianco	Silver	Cromo	Nero opaco
120	116↔122	55	47	<b>ZEPHYR2P116-</b>					785 €	873 €	960 €	960 €
140	136↔142	65	57	<b>ZEPHYR2P136-</b>					858 €	945 €	1.033 €	1.033 €
160	156↔162	75	67	<b>ZEPHYR2P156-</b>		+ 38 €	+ 38 €	+ 100 €	927 €	1.014 €	1.102 €	1.102 €
170	166↔172	79	72	<b>ZEPHYR2P166-</b>					943 €	1.030 €	1.119 €	1.119 €

**ZEPHYROS 2A** Installabile in nicchia, con fisso laterale o centro parete

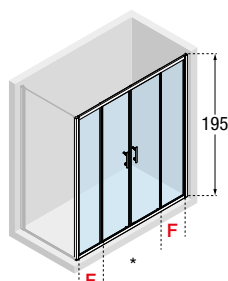

Reversibile

Misure				Codice	Scelta vetro				Scelta Profilo /Prezzo			
Larghezza piatto	Estensibilità	Fisso	Entrata (cm)		1	68	11	54	A	B	K	H
		<b>F</b>	<b>*</b>		Trasparente	Serigrafia Zephyros 1	Niva	Fumè	Bianco	Silver	Cromo	Nero opaco
160	156↔162	37	59	<b>ZEPHYR2A156-</b>					1.053 €	1.159 €	1.267 €	1.267 €
170	166↔172	40	64	<b>ZEPHYR2A166-</b>		+ 38 €	+ 38 €	+ 100 €	1.069 €	1.175 €	1.282 €	1.282 €
180	176↔182	42	69	<b>ZEPHYR2A176-</b>					1.084 €	1.190 €	1.298 €	1.298 €

## PER INSTALLAZIONE IN NICCHIA

Disegni tecnici per l'installazione vedi pag. 474

Quando la misura della nicchia è maggiore della estensibilità STANDARD ordinare i PROFILI DI COMPENSAZIONE (vedi paragrafo in fondo alla pagina)

## PER INSTALLAZIONE AD ANGOLO

Disegni tecnici per l'installazione vedi pag. 474

### ORDINARE 1 PANNELLO FISSO LATERALE

#### ZEPHYROS F

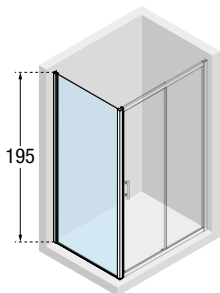

Reversibile

Misure		Codice	Scelta vetro				Scelta Profilo /Prezzo			
Larghezza piatto	Estensibilità		1	68	11	54	A	B	K	H
			Trasparente	Serigrafia Zephyros 1	Niva	Fumè	Bianco	Silver	Cromo	Nero opaco
70	68↔71	<b>ZEPHYRF68-</b>					324 €	352 €	379 €	379 €
75	73↔76	<b>ZEPHYRF73-</b>	+ 38 €				324 €	352 €	379 €	379 €
80	78↔81	<b>ZEPHYRF78-</b>		+ 38 €		+ 100 €	338 €	364 €	392 €	392 €
90	88↔91	<b>ZEPHYRF88-</b>					352 €	379 €	405 €	405 €

## PER INSTALLAZIONE A CENTRO PARETE

Disegni tecnici per l'installazione vedi pag. 474

### ORDINARE 2 PANNELLI FISSI LATERALI

#### ZEPHYROS F

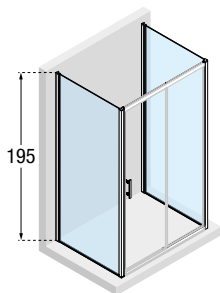

Reversibile

Misure		Codice	Scelta vetro				Scelta Profilo /Prezzo			
Profondità piatto	Estensibilità		1	68	11	54	A	B	K	H
			Trasparente	Serigrafia Zephyros 1	Niva	Fumè	Bianco	Silver	Cromo	Nero opaco
70	68↔71	<b>ZEPHYRF68-</b>					324 €	352 €	379 €	379 €
75	73↔76	<b>ZEPHYRF73-</b>	+ 38 €				324 €	352 €	379 €	379 €
80	78↔81	<b>ZEPHYRF78-</b>		+ 38 €		+ 100 €	338 €	364 €	392 €	392 €
90	88↔91	<b>ZEPHYRF88-</b>					352 €	379 €	405 €	405 €

### PROFILO DI COMPENSAZIONE

disegni tecnici per l'installazione vedi pag. 474

#### PROFILO DI COMPENSAZIONE + 15 mm

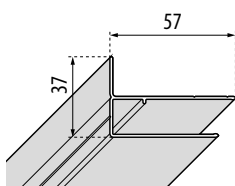

Profilo	Codice	Prezzo
Bianco	<b>P05BHCST-A</b>	77 €
Silver	<b>P05BHCST-B</b>	86 €
Cromo	<b>P05BHCST-K</b>	95 €
Nero opaco	<b>P05BHCST-H</b>	95 €

#### PROFILO DI COMPENSAZIONE A SCATTO + 25 mm

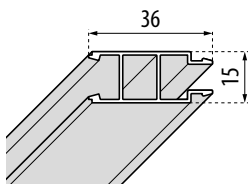

Profilo	Codice	Prezzo
Bianco	<b>P05HAAST3-A</b>	64 €
Silver	<b>P05HAAST3-B</b>	71 €
Cromo	<b>P05HAAST3-K</b>	79 €
Nero opaco	<b>P05HAAST3-H</b>	79 €

#### PROFILO DI COMPENSAZIONE PER GIADA H + 15 mm

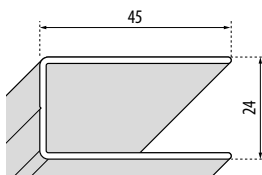

Profilo	Codice	Prezzo
Bianco	<b>P01BLMOST-A</b>	68 €
Silver	<b>P01BLMOST-B</b>	75 €
Cromo	<b>P01BLMOST-K</b>	84 €

### PANNELLO DI TAMPONAMENTO

sagomabile a misura (5-25 cm) H 207,5 cm

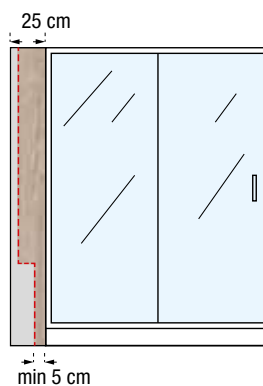

Il pannello di tamponamento è sagomabile e consente l'installazione di Revolution anche in presenza di ostacoli in muratura o di impiantistica sulla parete.

La misura minima dopo la sagomatura è di 50 mm.

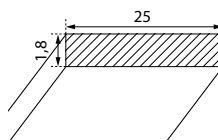

Finitura	Codice	Prezzo
Bianco	<b>REVO07A</b>	274 €
Bianco rigato	<b>REVO07I</b>	274 €
Burlington	<b>REVO07N</b>	274 €
Grain	<b>REVO07M</b>	274 €
Wenge	<b>REVO07V</b>	274 €

## 2 SPAZIO DOCCIA INSTALLABILE SOLO NELLA VERSIONE AD ANGOLO

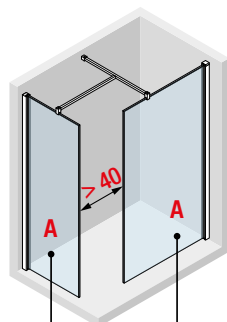

**GIADA H** LATO CORTO **GIADA H** LATO LUNGO

Per realizzare questa composizione ordinare 2 pezzi, uno per lato

Reversibile

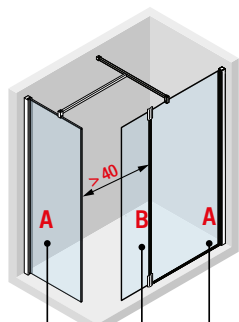

**GIADA H** LATO CORTO **GIADA H** LATO LUNGO

**GIADA HA** ANTINA GIREVOLE

Per realizzare questa composizione ordinare 3 pezzi: uno per lato + antina girevole HA

Reversibile

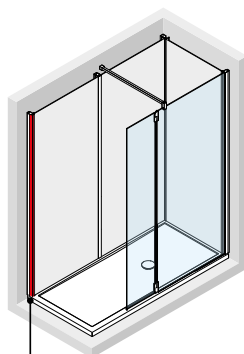

KIT DI FINITURA

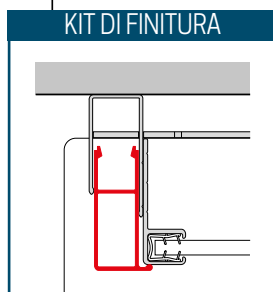

### GIADA H LATO LUNGO

Disegni tecnici per l'installazione vedi pag. 474

Misure		Codice	Scelta vetro		Scelta finitura / Prezzo		
Misura consigliata piatto	Misura filo lastra		1	44	A	B	K
Larghezza	<b>A</b>		Trasparente	Band Satin	Bianco	Silver	Cromo
120	67↔68,5	<b>GIADAH70-</b>			498 €	549 €	607 €
	77↔78,5	<b>GIADAH80-</b>			524 €	574 €	632 €
140	87↔88,5	<b>GIADAH90-</b>			537 €	588 €	645 €
160	107↔108,5	<b>GIADAH110-</b>		+ 38 €	568 €	625 €	689 €
170	117↔118,5	<b>GIADAH120-</b>			582 €	638 €	702 €
180	127↔128,5	<b>GIADAH130-</b>			594 €	652 €	715 €

### GIADA H LATO CORTO

Disegni tecnici per l'installazione vedi pag. 474

Misure		Codice	Scelta vetro		Scelta finitura / Prezzo		
Misura consigliata piatto	Misura filo lastra		1	44	A	B	K
Larghezza	<b>A</b>		Trasparente	Band Satin	Bianco	Silver	Cromo
70	67↔68,5	<b>GIADAH70-</b>			498 €	549 €	607 €
75	72↔73,5	<b>GIADAH75-</b>			510 €	562 €	619 €
80	77↔78,5	<b>GIADAH80-</b>		+ 38 €	524 €	574 €	632 €
90	87↔88,5	<b>GIADAH90-</b>			537 €	588 €	645 €

### GIADA HA ANTINA GIREVOLE

Misure		Codice	Scelta vetro		K
Misura consigliata piatto	Misura effettiva d'ingombro		1		
Larghezza	<b>B</b>		Trasparente		Cromo
70	37	<b>GIADAHA37-</b>			200 €

### Per versione senza GIADA H LATO CORTO ordinare il KIT DI FINITURA

Profilo	Codice	Prezzo
Bianco	<b>P51REGHST-A</b>	158 €
Silver	<b>P51REGHST-B</b>	175 €
Cromo	<b>P51REGHST-K</b>	193 €

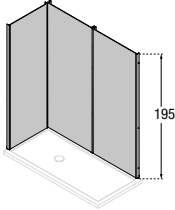
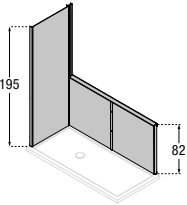
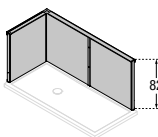
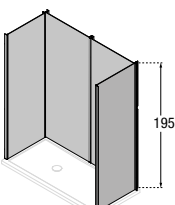
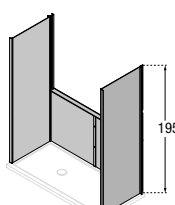
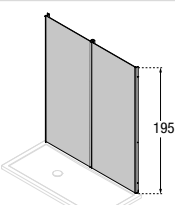
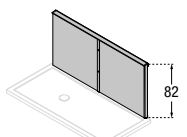

### 3 PANNELLI A MURO

COMBINAZIONI	Profondità	Larghezza / codice					Bianco	Nero	Prezzo
		120 cm	140 cm	160 cm	170 cm	180 cm	-A	-H	
<b>ANGOLO</b>									
	70	REVAA12070	REVAA14070	REVAA16070	REVAA17070	-			1.185 €
	75	-	REVAA14075	REVAA16075	REVAA17075	REVAA18075			1.185 €
	80	REVAA12080	REVAA14080	REVAA16080	REVAA17080	REVAA18080			1.185 €
	90	REVAA12090	REVAA14090	REVAA16090	REVAA17090	-			1.185 €
	70	REVAB12070	REVAB14070	REVAB16070	REVAB17070	-			1.047 €
	75	-	REVAB14075	REVAB16075	REVAB17075	REVAB18075			1.047 €
	80	REVAB12080	REVAB14080	REVAB16080	REVAB17080	REVAB18080			1.047 €
	90	REVAB12090	REVAB14090	REVAB16090	REVAB17090	-			1.047 €
	70	REVAC12070	REVAC14070	REVAC16070	REVAC17070	-			837 €
	75	-	REVAC14075	REVAC16075	REVAC17075	REVAC18075			837 €
	80	REVAC12080	REVAC14080	REVAC16080	REVAC17080	REVAC18080			837 €
	90	REVAC12090	REVAC14090	REVAC16090	REVAC17090	-			837 €
<b>NICCHIA SOLO ZEPHYROS</b>									
	70	REVNA12070	REVNA14070	REVNA16070	REVNA17070	-			1.533 €
	75	-	REVNA14075	REVNA16075	REVNA17075	REVNA18075			1.533 €
	80	REVNA12080	REVNA14080	REVNA16080	REVNA17080	REVNA18080			1.533 €
	90	REVNA12090	REVNA14090	REVNA16090	REVNA17090	-			1.533 €
	70	REVNB12070	REVNB14070	REVNB16070	REVNB17070	-			1.394 €
	75	-	REVNB14075	REVNB16075	REVNB17075	REVNB18075			1.394 €
	80	REVNB12080	REVNB14080	REVNB16080	REVNB17080	REVNB18080			1.394 €
	90	REVNB12090	REVNB14090	REVNB16090	REVNB17090	-			1.394 €
<b>CENTRO PARETE SOLO ZEPHYROS</b>									
	70, 75, 80, 90 cm	REVFA12080	REVFA14080	REVFA16080	REVFA17080	-			977 €
		REVFB12080	REVFB14080	REVFB16080	REVFB17080	-			768 €
	70, 75, 80, 90 cm	REVFB12080	REVFB14080	REVFB16080	REVFB17080	-			768 €

## 4 ACCESSORI



### COLONNA DOCCIA BASE

per disegni e dettagli tecnici vedi pag. 351

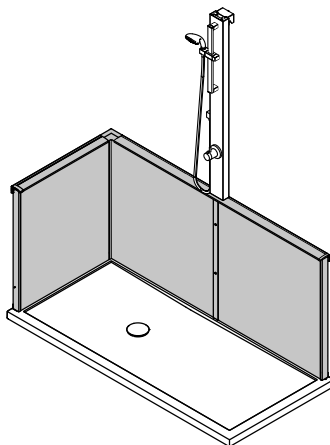

#### ATTACCO A MURO

	Codice	Prezzo
Meccanico	<b>REV2CM-K</b>	600 €
Termostatico	<b>REV2CT-K</b>	684 €

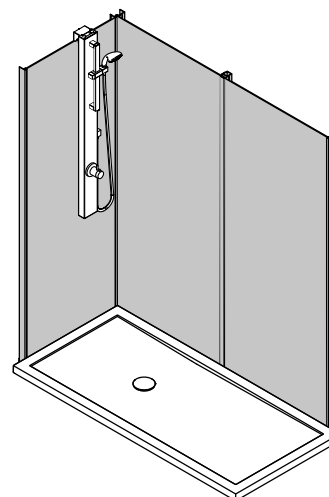

#### ATTACCO SU PANNELLO

	Codice	Prezzo
Meccanico	<b>REV2AM-K</b>	600 €
Termostatico	<b>REV2AT-K</b>	684 €



### COLONNA DOCCIA PLUS CON PORTAOGGETTI

per disegni e dettagli tecnici vedi pag. 351

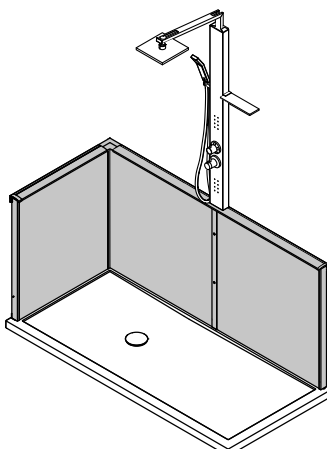

#### ATTACCO A MURO

	Codice	Prezzo
Meccanico	<b>REV2VM-K</b>	950 €
Termostatico	<b>REV2VT-K</b>	1.034 €

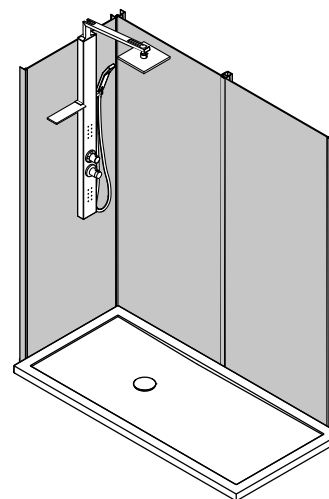

#### ATTACCO SU PANNELLO

	Codice	Prezzo
Meccanico	<b>REV2VM-K</b>	950 €
Termostatico	<b>REV2VT-K</b>	1.034 €

## 4 ACCESSORI



### SPECCHIO CON PORTAOGGETTI

Installabile a muro o su pannelli h 195 cm

Codice	Prezzo
<b>REVO01</b>	350 €

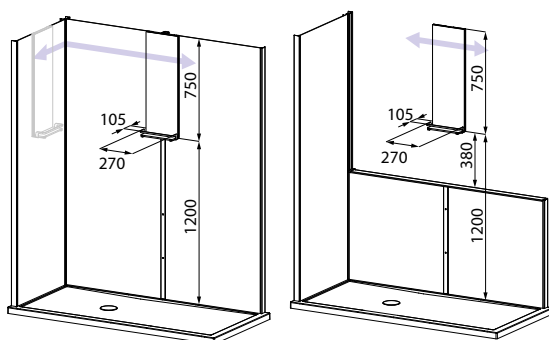

### PANNELLO DI TAMPONAMENTO

Sagomabile su misura (5-25 cm) h 207,5 cm

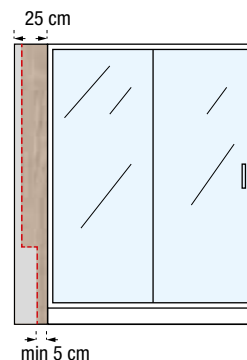

Finitura	Codice	Prezzo
Bianco	<b>REVO07A</b>	274 €
Bianco rigato	<b>REVO07I</b>	274 €
Burlington	<b>REVO07N</b>	274 €
Grain	<b>REVO07M</b>	274 €
Wenge	<b>REVO07V</b>	274 €



### SEDILE RECLINABILE

IN MATERIALE EVA  
impermeabile,  
antibatterico e atossico  
Portata indicativa 150 kg

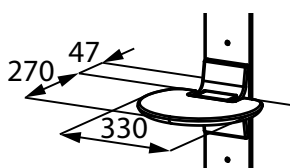

Colore	Codice	Prezzo
Bianco	<b>REVO03-A</b>	545 €
Nero	<b>REVO03-H</b>	545 €



### POGGIAPIEDI

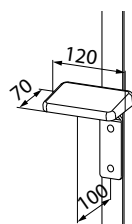

Colore	Codice	Prezzo
Bianco	<b>REVO02-A</b>	127 €
Nero	<b>REVO02-H</b>	127 €



### SCATOLA PER ALLACCI IDRAULICI

Completa di niples  
(flessibili non compresi)

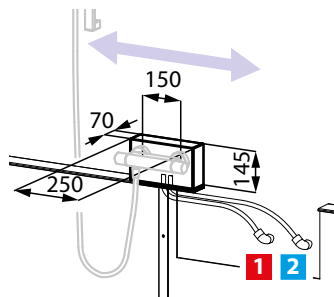

Codice	Prezzo
<b>REVO04-K</b>	247 €

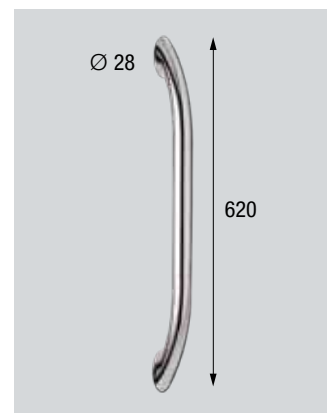

### MANIGLIONE

Codice	Prezzo
<b>R90MANGLO-C-K</b>	247 €

MODULO D'ORDINE

# COME PERSONALIZZARE LA TUA REVOLUTION 2 IN 5 MOSSE



<b>1</b>	<b>COMPLEMENTI D'ARREDO</b> p. 467	COD.
<b>2</b>	<b>PIATTO DOCCIA</b> p. 468	COD.
	<b>ZEPHYROS 2P</b>	COD.
<b>3</b>	<b>BOX DOCCIA</b> p. 468	COD.
	<b>ZEPHYROS S</b>	COD.
	<b>ZEPHYROS F</b>	COD.
<b>4</b>	<b>PANNELLI A MURO</b> p. 469	COD.
	<b>COLONNA</b>	COD.
	<b>SEDILE</b>	COD.
	<b>SPECCHIO</b>	COD.
<b>5</b>	<b>ACCESSORI</b> p. 469	COD.
	<b>POGGIAPIEDI</b>	COD.
	<b>MANIGLIONE</b>	COD.
	<b>SCATOLA PER ALLACCI IDRAULICI</b>	COD.

# REVOLUTION 2 CON COLONNA MULTIFUNZIONE

## 1 COMPLEMENTI D'ARREDO COLONNA MULTIFUNZIONE



### INSTALLAZIONE AD ANGOLO

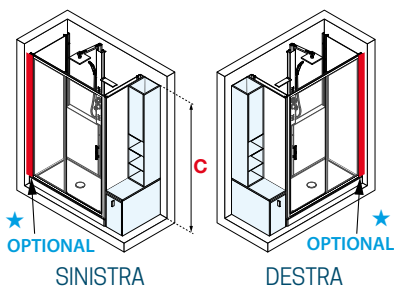

### FINITURA LACCATO



Bianco lucido

### FINITURA LEGNO



Bianco rigato



Burlington



Grain



Wenge

### INSTALLAZIONE A CENTRO PARETE

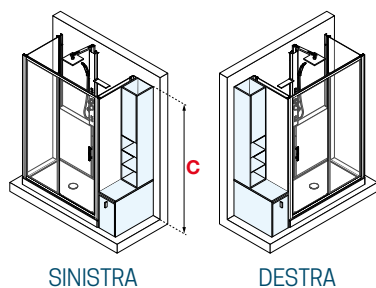

	Misure			Codice	Scelta finitura					Prezzo
	Larghezza	Altezza	Profondità		A	I	N	M	V	
					Bianco lucido	Bianco rigato	Burlington	Grain	Wenge	
		<b>C</b>								
Versione sinistra	32	207,5	70	<b>REVC08</b>						1.255 €
	32	207,5	75	<b>REVC09</b>						1.312 €
	32	207,5	80	<b>REVC10</b>						1.367 €
Versione destra	32	207,5	70	<b>REVC05</b>						1.255 €
	32	207,5	75	<b>REVC06</b>						1.312 €
	32	207,5	80	<b>REVC07</b>						1.367 €

Disegni tecnici per l'installazione vedi pag. 474

★ **OPTIONAL PANNELLO DI TAMPONAMENTO** (5-25 cm) sagomabile (solo per installazione ad angolo)

	A	I	N	M	V	Prezzo
Max 25- h 206,5						<b>REVC06</b> 274 €

- ANTE CON SOFT CLOSING
- RIPIANI INTERNI IN VETRO (5 MM)
- PORTABIANCHERIA INCLUSO

# REVOLUTION 2 CON COLONNA MULTIFUNZIONE

## 2 PIATTO DOCCIA - OLYMPIC PLUS

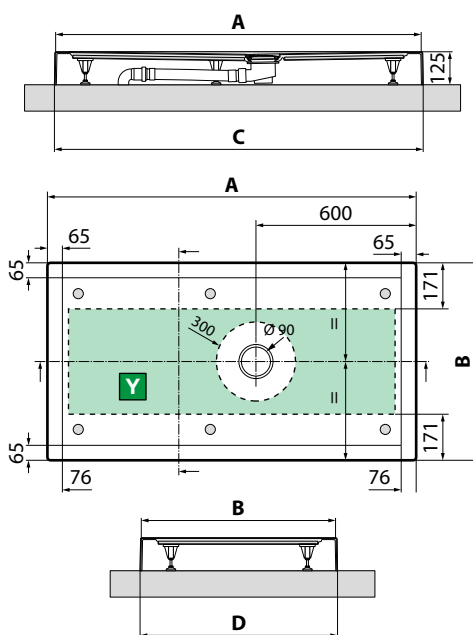

SPESSORE 12,5 CM

con antiscivolo

Misure	Codice	Scelta finitura / Prezzo						Codice	Prezzo
		30	79	11	27	29	28		
		Bianco	Bianco morbido	Beige	Corda	Grigio	Nero	Bianco	30
120 x 70	OL1207011-	277 €	442 €	468 €	468 €	468 €	468 €	OL1207011A-	409 €
120 x 80	OL8012011-	283 €	448 €	477 €	477 €	477 €	477 €	OL8012011A-	415 €
140 x 70	OL1407011-	297 €	463 €	490 €	490 €	490 €	490 €	OL1407011A-	429 €
140 x 75	OL1407511-	297 €	463 €	490 €	490 €	490 €	490 €	OL1407511A-	429 €
140 x 80	OL1408011-	322 €	487 €	515 €	515 €	515 €	515 €	OL1408011A-	454 €

\* Misure della parte superiore del piatto  
\*\* Misure del piatto a pavimento

Y Zona disponibile per lo scarico sopra pavimento

## 3 BOX DOCCIA

Disegni tecnici per l'installazione vedi p. 475

### PORTE

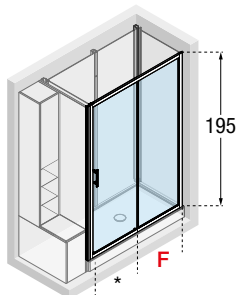

ZEPHYROS 2P Installabile ad angolo o a centro parete con fisso laterale

Misure				Codice	Scelta vetro				Scelta Profilo / Prezzo			
Larghezza piatto	Estensibilità	Fisso	Entrata (cm)		1	68	11	54	A	B	K	H
		F	*		Trasparente	Serigrafia Zephyros 1	Niva	Fumè	Bianco	Silver	Cromo	Nero opaco
120	116↔122	55	47	ZEPHYR2P116-					785 €	873 €	960 €	960 €
140	136↔142	65	57	ZEPHYR2P136-					858 €	945 €	1.033 €	1.033 €

Reversibile

## PER INSTALLAZIONE A CENTRO PARETE

Disegni tecnici per l'installazione vedi pag. 475

### 1 PANNELLO FISSO

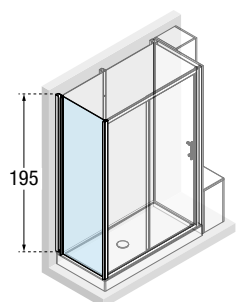

ZEPHYROS F

Misure		Codice	Scelta vetro				Scelta Profilo / Prezzo			
Profondità piatto	Estensibilità		1	68	11	54	A	B	K	H
			Trasparente	Serigrafia Zephyros 1	Niva	Fumè	Bianco	Silver	Cromo	Nero opaco
70	68↔71	ZEPHYRF68-					324 €	352 €	379 €	379 €
75	73↔76	ZEPHYRF73-	+ 38 €	+ 38 €	+ 100 €		324 €	352 €	379 €	379 €
80	78↔81	ZEPHYRF78-					338 €	364 €	392 €	392 €

Reversibile

# REVOLUTION 2 CON COLONNA MULTIFUNZIONE

## 4 PANNELLI A MURO

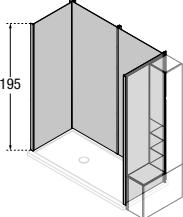
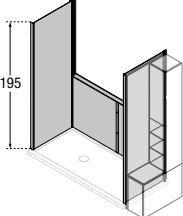
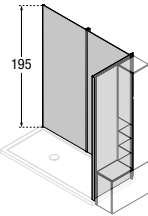
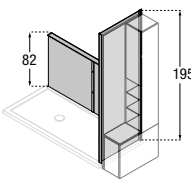
ANGOLO	Profondità	Larghezza / codice		Bianco	Nero	Prezzo
		120 cm	140 cm	-A	-H	
	70	<b>REVNA12070</b>	<b>REVNA14070</b>			1.533 €
	75	-	<b>REVNA14075</b>			1.533 €
	80	<b>REVNA12080</b>	<b>REVNA14080</b>			1.533 €
	70	<b>REVNB12070</b>	<b>REVNB14070</b>			1.394 €
	75	-	<b>REVNB14075</b>			1.394 €
	80	<b>REVNB12080</b>	<b>REVNB14080</b>			1.394 €
<b>CENTRO PARETE SOLO ZEPHYROS</b>		120 cm	140 cm	-A	-H	
	70	<b>REVAA12070</b>	<b>REVAA14070</b>			1.185 €
	75	-	<b>REVAA14075</b>			1.185 €
	80	<b>REVAA12080</b>	<b>REVAA14080</b>			1.185 €
	70	<b>REVAB12070</b>	<b>REVAB14070</b>			1.047 €
	75	-	<b>REVAB14075</b>			1.047 €
	80	<b>REVAB12080</b>	<b>REVAB14080</b>			1.047 €

## 5 ACCESSORI

	<b>COLONNA DOCCIA BASE</b>			<b>COLONNA DOCCIA PLUS CON PORTAOGGETTI</b>			<b>SPECCHIO CON PORTAOGGETTI</b>
	<b>ATTACCO A MURO</b>	<b>ATTACCO SU PANNELLO</b>		<b>ATTACCO A MURO</b>	<b>ATTACCO A PANNELLO</b>		<b>REVO01</b>
	Meccanico <b>REV2CM-K</b> 600 €	Meccanico <b>REV2AM-K</b> 600 €		Meccanico <b>REV2CVM-K</b> 950 €	Meccanico <b>REV2AVM-K</b> 950 €		350 €
	Termostatico <b>REV2CT-K</b> 684 €	Termostatico <b>REV2AT-K</b> 684 €		Termostatico <b>REV2CVT-K</b> 1.034 €	Termostatico <b>REV2AVT-K</b> 1.034 €		
	<b>SEDILE RECLINABILE</b>			<b>SCATOLA PER ALLACCI IDRAULICI</b>			<b>POGGIAPIEDI</b>
	Bianco <b>REVO03-A</b> 545 €	Nero <b>REVO03-H</b> 545 €		<b>REVO04-K</b>	Bianco <b>REVO02-A</b> 127 €		Nero <b>REVO02-H</b> 127 €
			247 €				Cromo <b>R90MANGLOK-K</b> 247 €

# REVOLUTION 2 CON PORTALAVATRICE

## 1 COMPLEMENTI D'ARREDO PORTALAVATRICE CON CASSETTIERE

SINISTRA

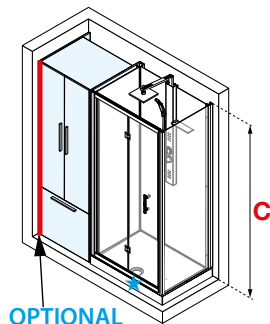

DESTRA

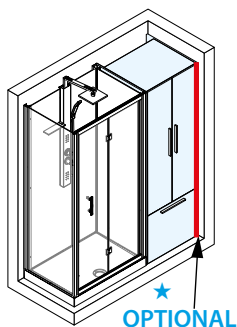

- ANTE CON SOFT CLOSING
- VASCHETTA RACCOGLI ACQUA CON SCARICO ESTERNO



VERSIONE SOLO MOBILE

### FINITURA LACCATO

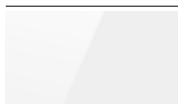

Bianco lucido

### FINITURA LEGNO



Bianco rigato



Burlington



Grain



Wenge

Misure			Codice	Scelta finitura					Prezzo
Larghezza	Altezza	Profondità		A	I	N	M	V	
				Bianco lucido	Bianco rigato	Burlington	Grain	Wenge	

### VERSIONE ABBINATA A BOX DOCCIA

72	206,5	70	<b>REVC01</b>						1.533 €
72	206,5	80	<b>REVC02</b>						1.604 €

### VERSIONE SOLO MOBILE

72	206,5	70	<b>REVCS1</b>						1.993 €
72	206,5	80	<b>REVCS2</b>						2.077 €

Disegni tecnici per l'installazione vedi pag. 475

★ **OPTIONAL** PANNELLO DI TAMPONAMENTO (5-25 cm) sagomabile (solo per installazione ad angolo)

			A	I	N	M	V	
	Max 25- h 206,5	<b>REVO06</b>						274 €

### OPTIONAL

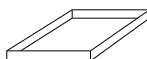

#### VASSOIO PORTA DETERSIVI

200 x 460 x H 30

Codice	Prezzo
<b>REVB11A</b>	134 €

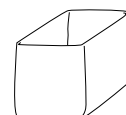

#### PORTA BIANCHERIA

360 x 460 x H 360

Codice	Prezzo
<b>REVB11B</b>	247 €



# REVOLUTION 2 CON PORTALAVATRICE+ASCIUGATRICE

## 1 COMPLEMENTI D'ARREDO PORTALAVATRICE + ASCIUGATRICE

SINISTRA

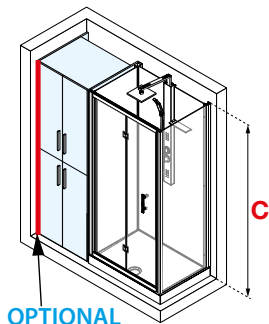

DESTRA

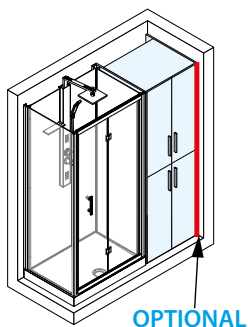

- ANTE CON SOFT CLOSING
- VASCHETTA RACCOGLI ACQUA CON SCARICO ESTERNO



### FINITURA LACCATO



Bianco lucido

### FINITURA LEGNO



Bianco rigato



Burlington



Grain



Wenge

Misure			Codice	Scelta finitura					Prezzo
Larghezza	Altezza	Profondità		A	I	N	M	V	
		<b>C</b>		Bianco lucido	Bianco rigato	Burlington	Grain	Wenge	

### VERSIONE ABBINATA A BOX DOCCIA

72	206,5	70	<b>REVC03</b>					1.394 €
72	206,5	80	<b>REVC04</b>					1.465 €

### VERSIONE SOLO MOBILE

72	206,5	70	<b>REVCS3</b>					1.938 €
72	206,5	80	<b>REVCS4</b>					2.022 €

Disegni tecnici per l'installazione vedi pag. 475

★ **OPTIONAL PANNELLO DI TAMPONAMENTO** (5-25 cm) sagomabile (solo per installazione ad angolo)

			A	I	N	M	V	
	Max 25- h 206,5	<b>REV006</b>						274 €



VERSIONE SOLO MOBILE

# REVOLUTION 2 CON PORTALAVATRICE

## 2 PIATTO DOCCIA - OLYMPIC

SPESORE 11,5 CM

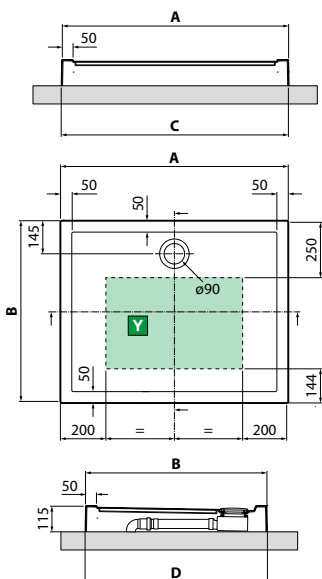

Misure			Codice	Scelta finitura / Prezzo					
				30	79	11	27	29	28
	<b>AxB*</b> ± 2 mm	<b>CxD**</b> ± 3 mm		Bianco	Bianco morbido	Beige	Corda	Grigio	Nero
90 x 70	894 x 694	898 x 698	<b>OLN907011-</b>	225 €	385 €	407 €	407 €	407 €	407 €
100 x 70	994 x 694	998 x 698	<b>OLN1007011-</b>	250 €	412 €	433 €	433 €	433 €	433 €
100 x 80	994 x 794	998 x 798	<b>OLN1008011-</b>	257 €	418 €	439 €	439 €	439 €	439 €
120 x 80	1194 x 794	1198 x 798	<b>OLN1208011-</b>	263 €	423 €	445 €	445 €	445 €	445 €

\* Misure della parte superiore del piatto  
\*\* Misure del piatto a pavimento

**Y** Zona disponibile per lo scarico sopra pavimento

### OPTIONAL

**PILETTA DI SCARICO**  
Ø 90

Codice	Prezzo
<b>PIL90PCAB-CR40</b>	37 €

## 3 BOX DOCCIA

Disegni tecnici per l'installazione vedi p. 475

### PORTE

#### ZEPHYROS S REVERSIBILE

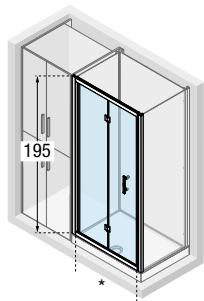

Misure				Codice	Scelta vetro				Scelta Profilo / Prezzo			
Larghezza piatto	Estensibilità	Fisso	Entrata (cm)		1	68	11	54	A	B	K	H
		<b>B</b>	*		Trasparente	Serigrafia Zephyros 1	Niva	Fumè	Bianco	Silver	Cromo	Nero opaco
90	86↔92	41	67	<b>ZEPHYRS86-</b>					752 €	829 €	907 €	907 €
100	96↔102	46	77	<b>ZEPHYRS96-</b>	+ 38 €	+ 38 €	+ 100 €		782 €	858 €	935 €	935 €

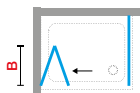

#### ZEPHYROS 2P REVERSIBILE

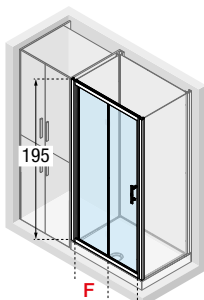

Misure				Codice	Scelta vetro				Scelta Profilo / Prezzo			
Larghezza piatto	Estensibilità	Fisso	Entrata (cm)		1	68	11	54	A	B	K	H
		<b>F</b>	*		Trasparente	Serigrafia Zephyros 1	Niva	Fumè	Bianco	Silver	Cromo	Nero opaco
120	116↔122	55	47	<b>ZEPHYR2P116-</b>	+ 38 €	+ 38 €	+ 100 €		785 €	870 €	958 €	958 €

### 1 PANNELLO FISSO

#### ZEPHYROS F REVERSIBILE

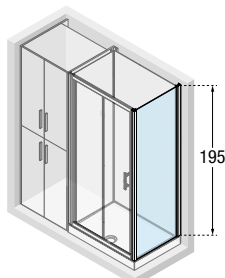

Misure		Codice	Scelta vetro				Scelta Profilo / Prezzo			
Profondità piatto	Estensibilità		1	68	11	54	A	B	K	H
			Trasparente	Serigrafia Zephyros 1	Niva	Fumè	Bianco	Silver	Cromo	Nero opaco
70	68↔71	<b>ZEPHYRF68-</b>					324 €	352 €	379 €	379 €
80	78↔81	<b>ZEPHYRF78-</b>	+ 38 €	+ 38 €	+ 100 €		338 €	364 €	392 €	392 €

# REVOLUTION 2 CON PORTALAVATRICE

## 4 PANNELLI A MURO

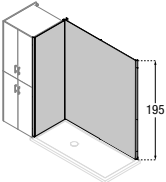
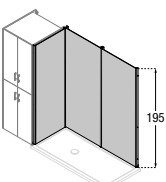
	Profondità	Larghezza / codice			Bianco	Nero	Prezzo
		90 cm	100 cm	120 cm	-A	-H	
<b>ANGOLO</b>							
	70	<b>REVAA9070</b>	<b>REVAA10070</b>	-			1.185 €
	80	-	<b>REVAA10080</b>	-			1.185 €
	80	-	-	<b>REVAA12080</b>			1.185 €

## 5 ACCESSORI

	<b>COLONNA DOCCIA BASE</b>			<b>COLONNA DOCCIA PLUS CON PORTAOGGETTI</b>			<b>SPECCHIO CON PORTAOGGETTI</b>
	<b>ATTACCO A MURO</b>	<b>ATTACCO SU PANNELLO</b>		<b>ATTACCO A MURO</b>	<b>ATTACCO A PANNELLO</b>		<b>REVO01</b>
	Meccanico <b>REV2CM-K</b> 600 €	Meccanico <b>REV2AM-K</b> 600 €		Meccanico <b>REV2AVM-K</b> 950 €	Meccanico <b>REV2CVM-K</b> 950 €		350 €
	Termostatico <b>REV2CT-K</b> 684 €	Termostatico <b>REV2AT-K</b> 684 €		Termostatico <b>REV2AVT-K</b> 1.034 €	Termostatico <b>REV2CVT-K</b> 1.034 €		

### INSTALLABILI SOLO PER LA MISURA 120x80

	<b>SEDILE RECLINABILE</b>		<b>POGGIAPIEDI</b>		Cromo <b>R90MANGLOC-K</b> 247 €
	Bianco <b>REVO03-A</b> 545 €		Bianco <b>REVO02-A</b> 127 €		
	Nero <b>REVO03-H</b> 545 €		Nero <b>REVO02-H</b> 127 €		

### OPTIONAL

#### PANNELLO DI TAMPONAMENTO (5-25 cm) H 206,5 cm (sagomabile su misura)

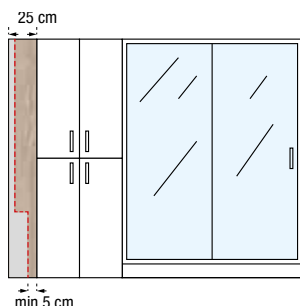

Finitura	Codice	Prezzo
Bianco	<b>REVO06A</b>	274 €
Bianco rigato	<b>REVO06I</b>	274 €
Burlington	<b>REVO06N</b>	274 €
Grain	<b>REVO06M</b>	274 €
Wenge	<b>REVO06V</b>	274 €

Il pannello di tamponamento è sagomabile e consente l'installazione di Revolution anche in presenza di ostacoli in muratura o di impiantistica sulla parete.

La misura minima dopo la sagomatura è di 50 mm.

**INSTALLAZIONE IN NICCHIA SOLO PER ZEPHYROS**

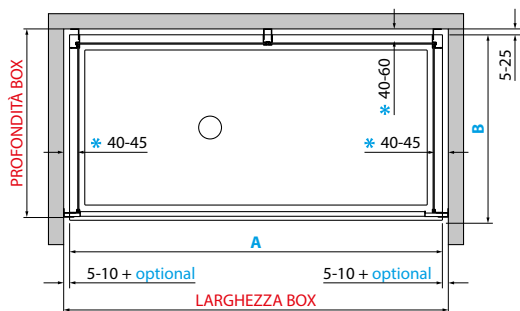

piatto	LARGHEZZA BOX				
A	STANDARD estensibilità	optional			
120	1205-1220	max 1245	max 1260	max 1275	max 1470
140	1405-1420	max 1445	max 1460	max 1475	max 1670
160	1605-1620	max 1645	max 1660	max 1675	max 1870
170	1705-1720	max 1745	max 1760	max 1775	max 1970
180	1805-1820	max 1845	max 1860	max 1875	max 2070

piatto	PROFONDITÀ BOX
B	STANDARD estensibilità
70	685-705
75	735-755
80	785-805
90	885-905

**INSTALLAZIONE CENTRO PARETE SOLO PER ZEPHYROS**

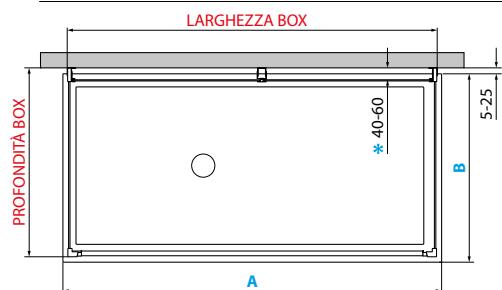

piatto	LARGHEZZA BOX	piatto	PROFONDITÀ BOX
A		B	
120	1175	70	685-705
140	1375	75	735-755
160	1575	80	785-805
170	1675		
180	1775		

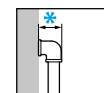

**ATTENZIONE!**  
Spazio disponibile per allacci idraulici

**INSTALLAZIONE AD ANGOLO PER ZEPHYROS E GIADA**

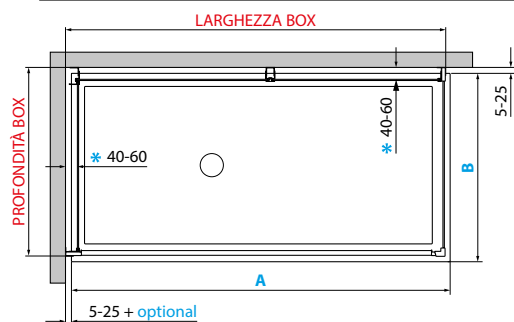

piatto	LARGHEZZA BOX		
A	STANDARD estensibilità	optional	PANNELLO di TAMPONAMENTO sagomabile su misura (50-250)
120	1190-1210	max 1225	max 1460
140	1390-1410	max 1425	max 1660
160	1590-1610	max 1625	max 1860
170	1690-1710	max 1725	max 1960
180	1790-1810	max 1825	max 2060

piatto	PROFONDITÀ BOX
B	STANDARD estensibilità
70	685-705
75	735-755
80	785-805
90	885-905

**INSTALLAZIONE AD ANGOLO PER PORTALAVATRICE / ASCIUGATRICE**

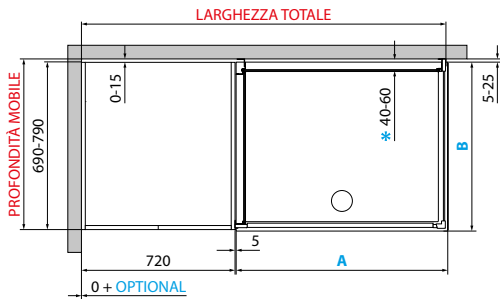

piatto	LARGHEZZA TOTALE	
<b>A</b>	<b>STANDARD</b>	<b>optional (50-250 mm)</b> PANNELLO DI TAMPONAMENTO sagomabile su misura
90	1610	max 1860
100	1710	max 1960
120	1910	max 2160

piatto	PROFONDITÀ MOBILE
<b>B</b>	
70	690-705
80	790-805

**INSTALLAZIONE AD ANGOLO PER COLONNA MULTIFUNZIONE**

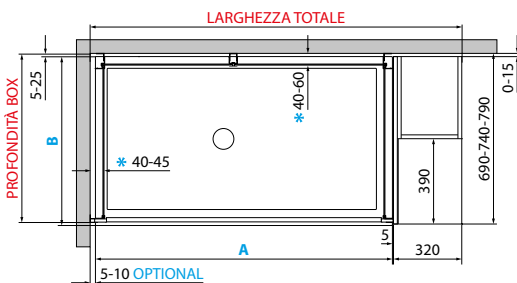

piatto	LARGHEZZA TOTALE	
<b>A</b>	<b>STANDARD</b>	<b>optional (50-250 mm)</b> PANNELLO DI TAMPONAMENTO sagomabile su misura
120	1525-1530	max 1780
140	1725-1730	max 1980

piatto	PROFONDITÀ BOX
<b>B</b>	
70	685-705
75	735-755
80	785-805

**INSTALLAZIONE CENTRO PARETE PER COLONNA MULTIFUNZIONE**

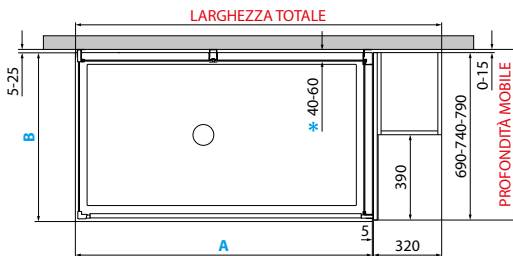

piatto	LARGHEZZA TOTALE	
<b>A</b>		
120	1510	
140	1710	

piatto	PROFONDITÀ MOBILE
<b>B</b>	
70	690-705
75	740-755
80	790-805

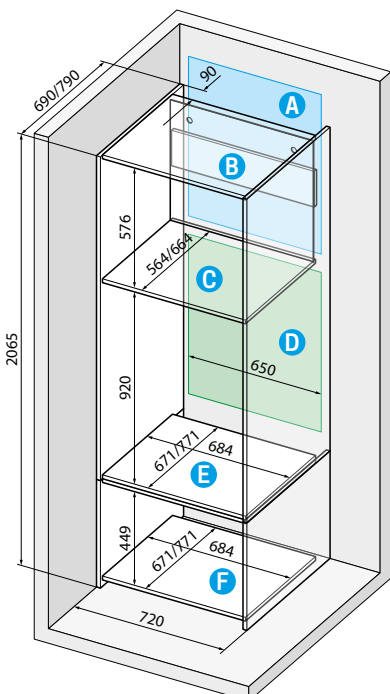

**MOBILE PORTALAVATRICE CON CASSETTIERE**

- A** Area allacci elettrici
- B** Vano con parete smontabile
- C** Piano appoggio biancheria
- D** Vano senza pareti posteriori per lo scarico e allacci idraulici
- E** Piano appoggio lavatrice
- F** Piano cassetto estraibile

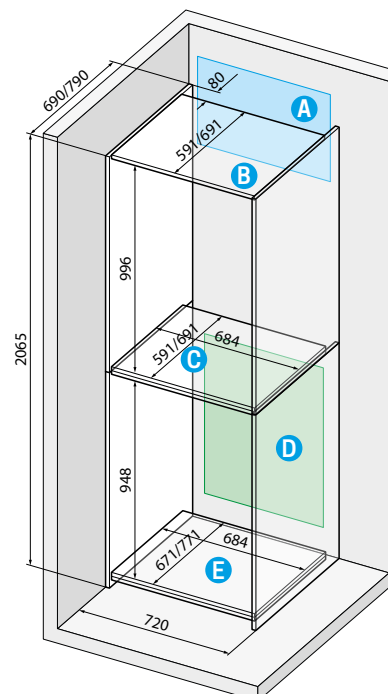

**MOBILE PORTALAVATRICE + ASCIUGATRICE**

- A** Area allacci elettrici
- B** Vano senza pareti posteriori
- C** Piano appoggio asciugatrice
- D** Vano senza pareti posteriori per lo scarico e allacci idraulici
- E** Piano appoggio lavatrice

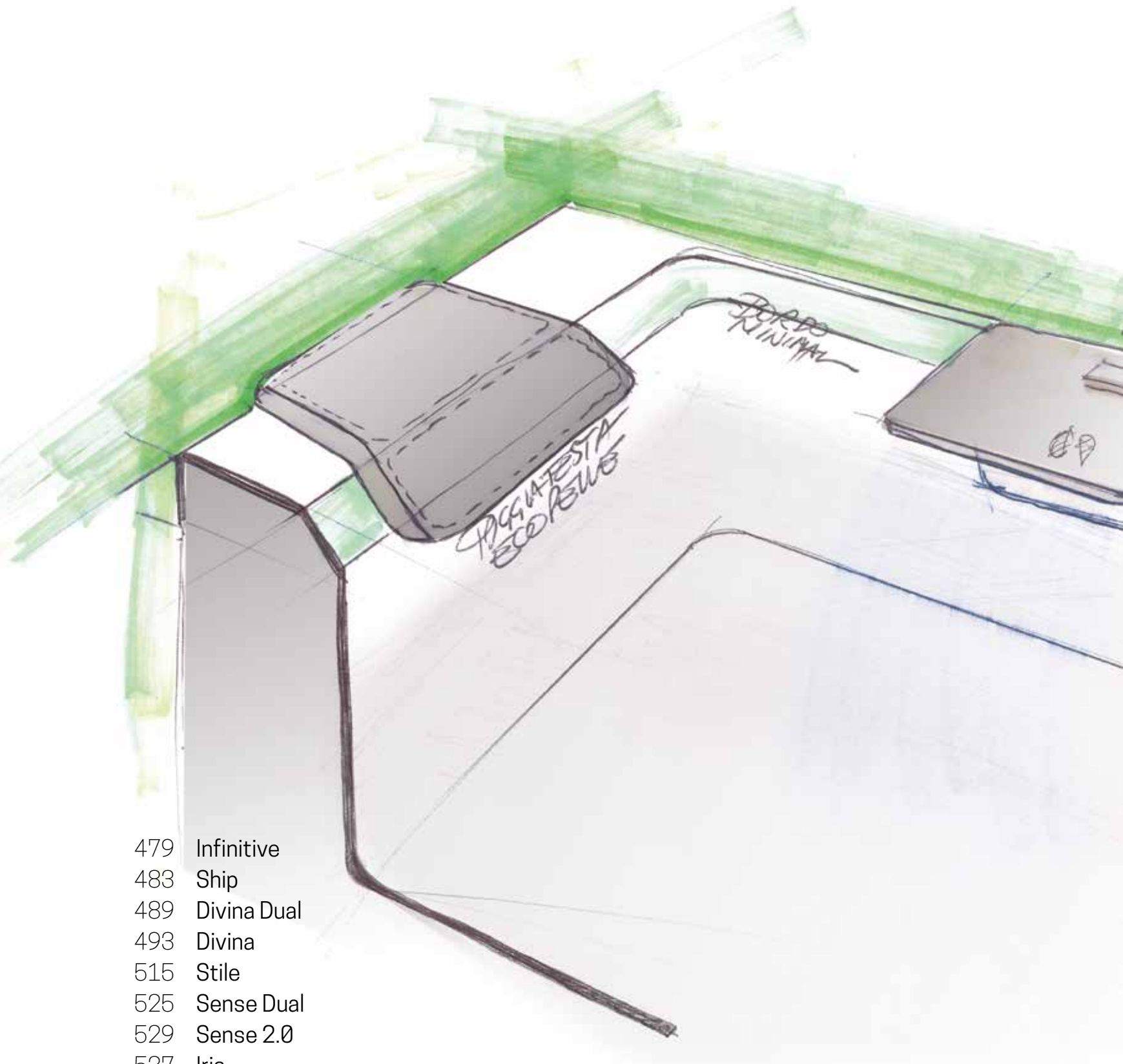

- 479 Infinitive
- 483 Ship
- 489 Divina Dual
- 493 Divina
- 515 Stile
- 525 Sense Dual
- 529 Sense 2.0
- 537 Iris
- 541 Calos
- 545 Calypso
- 547 Una
- 549 Vogue
- 551 Venus
- 552 Baby

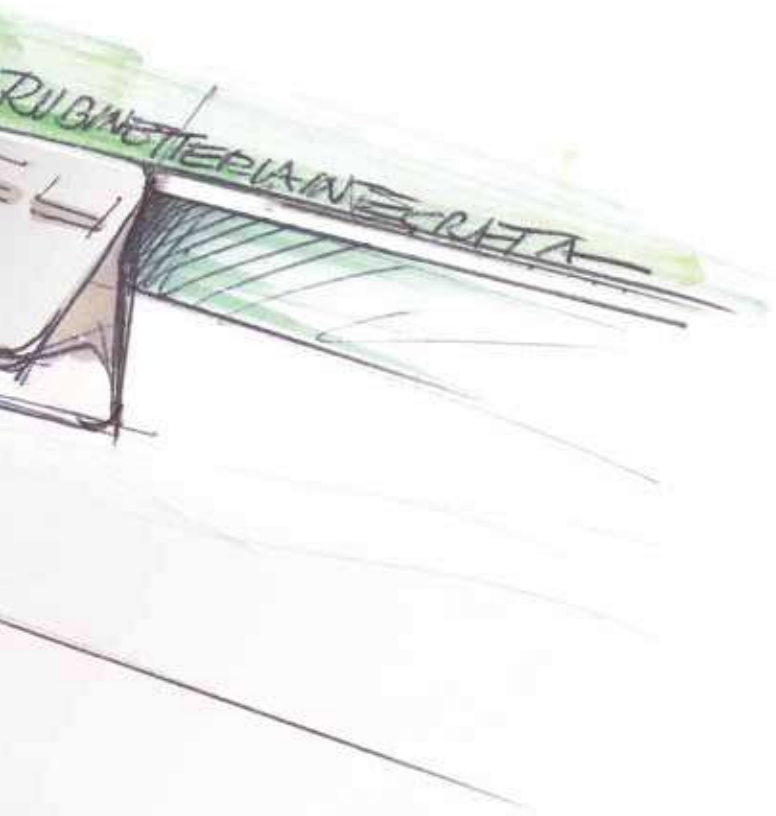

# VASCHE

IL MIGLIOR TEMPO  
DA REGALARE  
A SE STESSI.

Immagina un'esperienza rigenerante a 360°, capace di risvegliare corpo e rivitalizzare lo spirito. Con la vasca da bagno ti regali un momento di puro relax e dai forma al tuo spazio in cui colori, lusso e forme si fondono in un ambiente unico e dal carattere deciso. Regola il flusso d'aria con i programmi specifici e abbandonati ad un momento indimenticabile. L'offerta dei sistemi benessere delle vasche Novellini - funzioni, dotazioni e optional - è davvero ampia e si adatta a qualsiasi necessità.



VASCA SENAPE CON MOBILE CENTRO PARETE E LUCE LED ESTERNA



VASCA RUBINO FREESTANDING CON LUCE LED ESTERNA

## NOVOTECH: AVANGUARDIA, CREATIVITÀ E RESISTENZA

Novotech il solid surface di nuova generazione. Omogeneo in tutto il suo spessore, piacevole al tatto e capace di creare un impatto visivo completamente nuovo, in perfetta armonia con il design essenziale di Novellini. La sintesi di una eccellenza.



## INFINITIVE | FINITURE

Porta il colore nel tuo bagno, personalizza il tuo stile! Novellini ti mette a disposizione una scelta tra 64 colori laccati opachi tra i quali liberare la tua fantasia.

◆ SCELTA COLORE - PER TUTTI I COLORI DISPONIBILI VEDI PAG. 487

## INFINITIVE | FUNZIONI E DOTAZIONI (disponibili a seconda dell'allestimento)

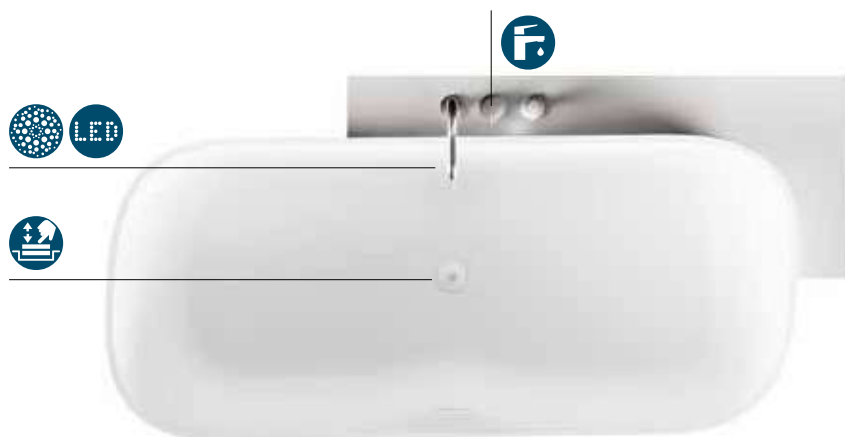

Natural air



Luce led bianca interna



Rubinetteria bordo vasca



Colonna di scarico con piletta  
click-clack.

VASCA DOTATA DI TROPPO PIENO INTEGRATO  
CONFORME ALLA NORMATIVA VIGENTE



Designed by Simone Micheli





VASCA BIANCO MORBIDO CON LUCE LED ESTERNA

INFINITIVE



Mobile per vasca: tecnologia ed estetica



Il tuo bagno, il tuo colore, la tua personalità



Lasciati avvolgere dalle micro bolle che accarezzano silenziosamente il corpo e favoriscono l'ossigenazione della pelle. Il piacere di un massaggio, immersi in un design armonioso.



Luce LED esterna perimetrale



# INFINITIVE

# INFINITIVE

**VASCA IN NOVOTECH - INTERNO BIANCO OPACO, ESTERNO CUSTOMIZZABILE.  
IN ABBINAMENTO MOBILE CON COLORE CUSTOMIZZABILE E PIANO IN NOVOTECH BIANCO OPACO**

Misure Capacità			Scelta installazione mobile	Codice	Scelta finitura Esterno vasca		Scelta Finitura mobile						
Cm	H	Lt.			U	◆	Legni						
					Bianco opaco	Scelta colore	Bianco opaco	Bianco rigato	Grain	Burlington	Wenge	Scelta colore	
<b>STANDARD</b>													
170 x 75	70	360	-	<b>INF1170750-</b>	4.300 €	+ 780 €	U	I	M	N	V	◆	
<b>STANDARD CON MOBILE</b>													
170 x 75	70	360	centro stanza	<b>INF1170750CS-</b>	5.212 €	+ 780 €	U	I	M	N	V	◆	
170 x 75	70	360	centro parete	<b>INF1170750CP-</b>			+ 75 €	+ 75 €	+ 75 €	+ 75 €		+ 170 €	
170 x 75	70	360	angolo destro	<b>INF1170750AD-</b>	5.353 €		+ 138 €	+ 138 €	+ 138 €	+ 138 €			
170 x 75	70	360	angolo sinistro	<b>INF1170750AS-</b>									
<b>STANDARD CON MOBILE E CON RUBINETTERIA BORDO VASCA</b>													
170 x 75	70	360	centro stanza	<b>INF1170752CS-</b>	5.612 €	+ 780 €	U	I	M	N	V	◆	
170 x 75	70	360	centro parete	<b>INF1170752CP-</b>			+ 75 €	+ 75 €	+ 75 €	+ 75 €		+ 170 €	
170 x 75	70	360	angolo destro	<b>INF1170752AD-</b>	5.753 €		+ 138 €	+ 138 €	+ 138 €	+ 138 €			
170 x 75	70	360	angolo sinistro	<b>INF1170752AS-</b>									
<b>NATURAL AIR CON MOBILE</b>													
170 x 75	70	360	centro stanza	<b>INFN1707500CS-</b>	8.648 €	+ 780 €	U	I	M	N	V	◆	
170 x 75	70	360	centro parete	<b>INFN1707500CP-</b>			+ 75 €	+ 75 €	+ 75 €	+ 75 €		+ 170 €	
170 x 75	70	360	angolo destro	<b>INFN1707500AD-</b>	9.233 €		+ 138 €	+ 138 €	+ 138 €	+ 138 €			
170 x 75	70	360	angolo sinistro	<b>INFN1707500AS-</b>									
<b>NATURAL AIR CON MOBILE E CON RUBINETTERIA BORDO VASCA</b>													
170 x 75	70	360	centro stanza	<b>INFN1707502CS-</b>	9.048 €	+ 780 €	U	I	M	N	V	◆	
170 x 75	70	360	centro parete	<b>INFN1707502CP-</b>			+ 75 €	+ 75 €	+ 75 €	+ 75 €		+ 170 €	
170 x 75	70	360	angolo destro	<b>INFN1707502AD-</b>	9.633 €		+ 138 €	+ 138 €	+ 138 €	+ 138 €			
170 x 75	70	360	angolo sinistro	<b>INFN1707502AS-</b>									



◆ SCELTA COLORE - PER TUTTI I COLORI DISPONIBILI VEDI PAG. 487

**OPTIONAL: LUCE LED ESTERNA E PIANTANA, VEDI PAG. 486**



INFINITE

**MOBILE PER VASCA: TECNOLOGIA ED ESTETICA**

Il mobile proposto è il complemento ideale per aggiungere funzionalità alla vasca. Dotato di rubinetteria con un essenziale e funzionale design, ospita al suo interno tutta la parte tecnologica. Si può scegliere in diverse finiture, o variante colore in tinta con la vasca.

**NATURAL AIR: PIACERE, SILENZIO E FELICITÀ**

La tecnologia Natural Air, 100% made in Italy, certificata e garantita da Novellini, trasformerà il momento del bagno in un rifugio silenzioso in grado di avvolgere il corpo donandogli uno stato psico-fisico di assoluto relax.

FREESTANDING



FREESTANDING / CENTRO PARETE CON MOBILE CENTRALE E RUBINETTERIA



AD ANGOLO SINISTRO CON MOBILE E RUBINETTERIA



AD ANGOLO DESTRO CON MOBILE E RUBINETTERIA





VASCA TERRA FREESTANDING CON LUCE LED ESTERNA



VASCA BIANCA FREESTANDING CON LUCE LED ESTERNA

## NOVOTECH: AVANGUARDIA, CREATIVITÀ E RESISTENZA

Novotech il solid surface di nuova generazione. Omogeneo in tutto il suo spessore, piacevole al tatto e capace di creare un impatto visivo completamente nuovo, in perfetta armonia con il design essenziale di Novellini. La sintesi di una eccellenza.

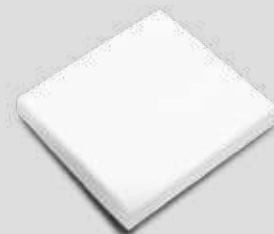

## SHIP | FINITURE

Porta il colore nel tuo bagno, personalizza il tuo stile! Novellini ti mette a disposizione una scelta tra 64 colori laccati opachi tra i quali liberare la tua fantasia.

◆ SCELTA COLORE - PER TUTTI I COLORI DISPONIBILI VEDI PAG. 487

## SHIP | FUNZIONI E DOTAZIONI (disponibili a seconda dell'allestimento)



Natural air



Luce led bianca interna



Rubinetteria bordo vasca



Colonna di scarico con piletta  
click-clack.

VASCA DOTATA DI TROPPO PIENO INTEGRATO  
CONFORME ALLA NORMATIVA VIGENTE



Designed by Simone Micheli



VASCA SENAPE CON LUCE LED ESTERNA

SHIP



Mobile per vasca: tecnologia ed estetica



Il tuo bagno, il tuo colore, la tua personalità



Lasciati avvolgere dalle micro bolle che accarezzano silenziosamente il corpo e favoriscono l'ossigenazione della pelle. Il piacere di un massaggio, immersi in un design armonioso.



Luce LED esterna perimetrale



SHIP

# SHIP

**VASCA IN NOVOTECH - INTERNO BIANCO OPACO, ESTERNO CUSTOMIZZABILE.  
IN ABBINAMENTO MOBILE CON COLORE CUSTOMIZZABILE E PIANO IN NOVOTECH BIANCO OPACO**

Misure		Capacità	Scelta installazione mobile	Codice	Scelta finitura Esterno vasca	Scelta Finitura mobile						
Cm	H	Lt.			Bianco opaco	Legni					Scelta colore	
					Scelta colore	Bianco rigato	Grain	Burlington	Wenge			
<b>STANDARD</b>												
					U	◆	U	I	M	N	V	◆
150 x 70	62	265	-	<b>SHI115070-</b>	3.500 €	+ 780 €						
160 x 70	62	280	-	<b>SHI116070-</b>	3.900 €							
<b>STANDARD CON MOBILE</b>												
					U	◆	U	I	M	N	V	◆
150 x 70	62	265	centro stanza	<b>SHI1150700CS-</b>	4.417 €	+ 780 €		+ 75 €	+ 75 €	+ 75 €	+ 75 €	+ 170 €
150 x 70	62	265	centro parete	<b>SHI1150700CP-</b>								
150 x 70	62	265	angolo destro	<b>SHI1150700AD-</b>	4.558 €			+ 138 €	+ 138 €	+ 138 €	+ 138 €	
150 x 70	62	265	angolo sinistro	<b>SHI1150700AS-</b>								
160 x 70	62	280	centro stanza	<b>SHI1160700CS-</b>	4.811 €			+ 75 €	+ 75 €	+ 75 €	+ 75 €	
160 x 70	62	280	centro parete	<b>SHI1160700CP-</b>								
160 x 70	62	280	angolo destro	<b>SHI1160700AD-</b>	4.952 €			+ 138 €	+ 138 €	+ 138 €	+ 138 €	
160 x 70	62	280	angolo sinistro	<b>SHI1160700AS-</b>								
<b>STANDARD CON MOBILE E CON RUBINETTERIA BORDO VASCA</b>												
					U	◆	U	I	M	N	V	◆
150 x 70	62	265	centro stanza	<b>SHI1150702CS-</b>	4.817 €	+ 780 €		+ 75 €	+ 75 €	+ 75 €	+ 75 €	+ 170 €
150 x 70	62	265	centro parete	<b>SHI1150702CP-</b>								
150 x 70	62	265	angolo destro	<b>SHI1150702AD-</b>	4.958 €			+ 138 €	+ 138 €	+ 138 €	+ 138 €	
150 x 70	62	265	angolo sinistro	<b>SHI1150702AS-</b>								
160 x 70	62	280	centro stanza	<b>SHI1160702CS-</b>	5.211 €			+ 75 €	+ 75 €	+ 75 €	+ 75 €	
160 x 70	62	280	centro parete	<b>SHI1160702CP-</b>								
160 x 70	62	280	angolo destro	<b>SHI1160702AD-</b>	5.352 €			+ 138 €	+ 138 €	+ 138 €	+ 138 €	
160 x 70	62	280	angolo sinistro	<b>SHI1160702AS-</b>								
<b>NATURAL AIR CON MOBILE</b>												
					U	◆	U	I	M	N	V	◆
150 x 70	62	265	centro stanza	<b>SHIN1507000CS-</b>	7.871 €	+ 780 €		+ 75 €	+ 75 €	+ 75 €	+ 75 €	+ 170 €
150 x 70	62	265	centro parete	<b>SHIN1507000CP-</b>								
150 x 70	62	265	angolo destro	<b>SHIN1507000AD-</b>	8.459 €			+ 138 €	+ 138 €	+ 138 €	+ 138 €	
150 x 70	62	265	angolo sinistro	<b>SHIN1507000AS-</b>								
160 x 70	62	280	centro stanza	<b>SHIN1607000CS-</b>	8.245 €			+ 75 €	+ 75 €	+ 75 €	+ 75 €	
160 x 70	62	280	centro parete	<b>SHIN1607000CP-</b>								
160 x 70	62	280	angolo destro	<b>SHIN1607000AD-</b>	8.829 €			+ 138 €	+ 138 €	+ 138 €	+ 138 €	
160 x 70	62	280	angolo sinistro	<b>SHIN1607000AS-</b>								
<b>NATURAL AIR CON MOBILE E CON RUBINETTERIA BORDO VASCA</b>												
					U	◆	U	I	M	N	V	◆
150 x 70	62	265	centro stanza	<b>SHIN1507002CS-</b>	8.271 €	+ 780 €		+ 75 €	+ 75 €	+ 75 €	+ 75 €	+ 170 €
150 x 70	62	265	centro parete	<b>SHIN1507002CP-</b>								
150 x 70	62	265	angolo destro	<b>SHIN1507002AD-</b>	8.859 €			+ 138 €	+ 138 €	+ 138 €	+ 138 €	
150 x 70	62	265	angolo sinistro	<b>SHIN1507002AS-</b>								
160 x 70	62	280	centro stanza	<b>SHIN1607002CS-</b>	8.645 €			+ 75 €	+ 75 €	+ 75 €	+ 75 €	
160 x 70	62	280	centro parete	<b>SHIN1607002CP-</b>								
160 x 70	62	280	angolo destro	<b>SHIN1607002AD-</b>	9.229 €			+ 138 €	+ 138 €	+ 138 €	+ 138 €	
160 x 70	62	280	angolo sinistro	<b>SHIN1607002AS-</b>								

**OPTIONAL: LUCE LED ESTERNA E PIANTANA, VEDI PAG. 486**





◆ SCELTA COLORE - PER TUTTI I COLORI DISPONIBILI VEDI PAG. 487



**MOBILE PER VASCA: TECNOLOGIA ED ESTETICA**

Il mobile proposto è il complemento ideale per aggiungere funzionalità alla vasca. Dotato di rubinetteria con un essenziale e funzionale design, ospita al suo interno tutta la parte tecnologica. Si può scegliere in diverse finiture, o variante colore in tinta con la vasca.

**NATURAL AIR: PIACERE, SILENZIO E FELICITÀ**

La tecnologia Natural Air, 100% made in Italy, certificata e garantita da Novellini, trasformerà il momento del bagno in un rifugio silenzioso in grado di avvolgere il corpo donandogli uno stato psicofisico di assoluto relax.

FREESTANDING



FREESTANDING / CENTRO PARETE CON MOBILE CENTRALE E RUBINETTERIA



AD ANGOLO SINISTRO CON MOBILE E RUBINETTERIA



AD ANGOLO DESTRO CON MOBILE E RUBINETTERIA



SHIP



PIANTANA DA TERRA

Finitura	Codice	Prezzo
Cromo	<b>RUBPVASRSN-K</b>	1.438 €
Nero opaco	<b>RUBPVASRSN-H</b>	1.688 €

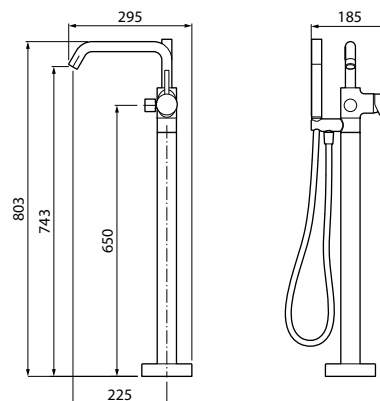

KIT LED PERIMETRALI INFERIORI  
PER VASCA INFINITIVE

Codice	Prezzo
<b>KLINF</b>	350 €

KIT LED PERIMETRALI INFERIORI  
PER VASCA SHIP

Misure (cm)	Codice	Prezzo
150	<b>KLSHI150</b>	350 €
160	<b>KLSHI160</b>	



## COLORI SPECIALI SU RICHIESTA

<b>NERO</b>  cod. <b>19</b>	<b>TORBA</b>  cod. <b>S6</b>	<b>FUCILE</b>  cod. <b>F9</b>	<b>LAPIS</b>  cod. <b>S7</b>	<b>GRES</b>  cod. <b>S8</b>	<b>CRETA</b>  cod. <b>S9</b>	<b>BASALTO</b>  cod. <b>SA</b>	<b>CENERE</b>  cod. <b>7P</b>	<b>GRIGIO 29</b>  cod. <b>FL</b>
<b>OMBRA</b>  cod. <b>RQ</b>	<b>PERLA</b>  cod. <b>FD</b>	<b>TOPO</b>  cod. <b>RR</b>	<b>BISCOTTO</b>  cod. <b>RH</b>	<b>CAFFELATTE</b>  cod. <b>RJ</b>	<b>CARRUBA</b>  cod. <b>S4</b>	<b>AMARANTO</b>  cod. <b>S3</b>	<b>CAFFÈ</b>  cod. <b>S5</b>	<b>CORTECCIA</b>  cod. <b>FA</b>
<b>CASTAGNO</b>  cod. <b>RE</b>	<b>COCCIO</b>  cod. <b>RP</b>	<b>TARTUFO</b>  cod. <b>RN</b>	<b>TERRA</b>  cod. <b>FB</b>	<b>CORDA 27</b>  cod. <b>FK</b>	<b>TORTORA ARGILLA</b>  cod. <b>RM</b>	<b>TORTORA N2</b>  cod. <b>FN</b>	<b>POLVERE</b>  cod. <b>RS</b>	<b>IUTA</b>  cod. <b>FC</b>
<b>ECRU</b>  cod. <b>RL</b>	<b>GRIGIO CHIARO N1</b>  cod. <b>FM</b>	<b>PIETRA</b>  cod. <b>RK</b>	<b>BEIGE 11</b>  cod. <b>FG</b>	<b>SALMONE</b>  cod. <b>RX</b>	<b>PELLE</b>  cod. <b>RY</b>	<b>CONFETTO</b>  cod. <b>RF</b>	<b>AVORIO</b>  cod. <b>RG</b>	<b>CIPRIA</b>  cod. <b>7L</b>
<b>TEGOLA</b>  cod. <b>7M</b>	<b>ARAGOSTA</b>  cod. <b>F1</b>	<b>POMODORO</b>  cod. <b>S1</b>	<b>RUBINO</b>  cod. <b>F2</b>	<b>CARDINALE</b>  cod. <b>S2</b>	<b>CARDO</b>  cod. <b>RD</b>	<b>BLU BRILLANTE N0</b>  cod. <b>X2</b>	<b>MARE</b>  cod. <b>R0</b>	<b>NEMBO</b>  cod. <b>RC</b>
<b>PERSIA</b>  cod. <b>RB</b>	<b>SABBIA</b>  cod. <b>RT</b>	<b>LAGO</b>  cod. <b>RA</b>	<b>CACTUS</b>  cod. <b>R9</b>	<b>SALVIA</b>  cod. <b>R8</b>	<b>PINO</b>  cod. <b>R7</b>	<b>DENIM</b>  cod. <b>R1</b>	<b>FERRO</b>  cod. <b>R3</b>	<b>SKY</b>  cod. <b>R2</b>
<b>ROCCIA</b>  cod. <b>R6</b>	<b>ALGA</b>  cod. <b>7N</b>	<b>CALCE</b>  cod. <b>R4</b>	<b>ARTICO</b>  cod. <b>F8</b>	<b>TURCHINO</b>  cod. <b>F7</b>	<b>LIME</b>  cod. <b>F6</b>	<b>SENAPE</b>  cod. <b>F5</b>	<b>PERGAMENA</b>  cod. <b>RV</b>	<b>CONCHIGLIA</b>  cod. <b>RW</b>

OPTIONAL



VASCA BIANCO MORBIDO CON PANNELLI ARGILLA TORTORA



VASCA BIANCO MORBIDO CON PANNELLI GRAIN + FRAME NERO OPACO

## DIVINA DUAL | FINITURE PANNELLI

### ACRILICO



Bianco  
lucido

Bianco  
morbido

### LEGNO



Bianco  
rigato

Grain

Burlington

Dolomite

### ARGILLA

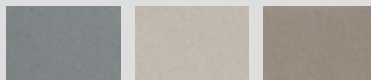

Cenere

Polvere

Tortora

### MDI



Umbra

Sabbia

### FRAME ALLUMINIO NERO OPACO



Bianco  
morbido

### LEGNO



Bianco  
rigato

Grain

Burlington

Dolomite

### ARGILLA

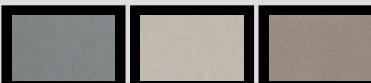

Cenere

Polvere

Tortora

### MDI



Umbra

Sabbia

### FRAME ALLUMINIO BIANCO OPACO

### LEGNO



Bianco  
rigato

Grain

Burlington

Dolomite

### ARGILLA

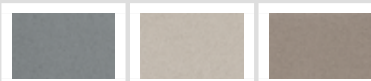

Cenere

Polvere

Tortora

### MDI

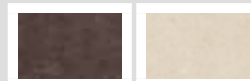

Umbra

Sabbia

## DIVINA DUAL | FUNZIONI E DOTAZIONI (disponibili a seconda dell'allestimento)

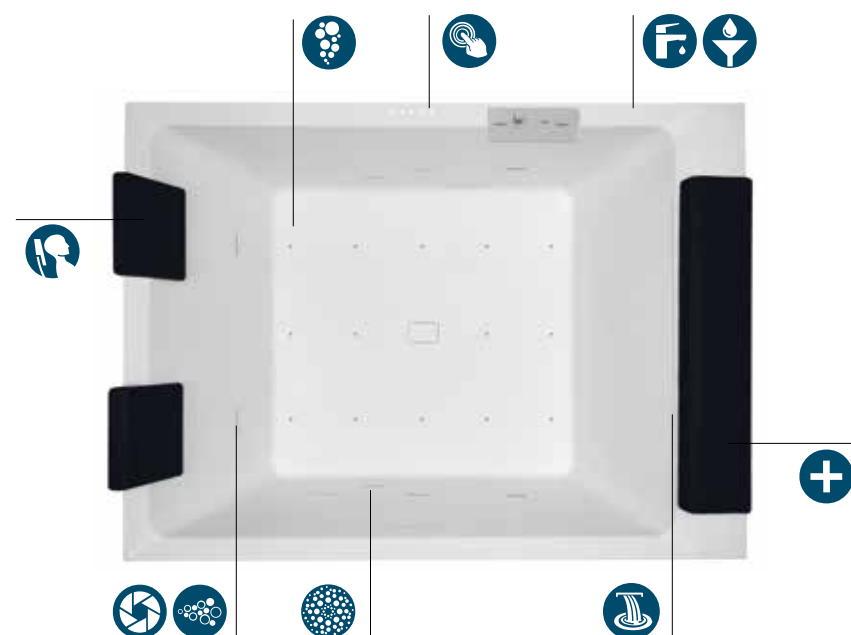

**Massaggio Airpool** a getto d'aria con accensione manuale on/off o programma sequenziale (alternata). Per una **efficace stimolazione cellulare**.



**Massaggio corpo Whirlpool** aria/acqua. Per soddisfare qualsiasi esigenza di benessere.



**Natural air**



**Cromolight** con 8 variazioni cromatiche per attivare la mente ed emozionare lo spirito.



**Accensione soft-touch**



**Poggiatesta** in materiale antibatterico



**Disinfezione**



**Rubinetteria bordo vasca** con tubo di scarico salvagoccia



**Cascata**



VASCA BIANCO MORBIDO CON PANNELLI ARGILLA POLVERE E FRAME NERO OPACO



Boiserie Frame



Cascata



Avvolgere il corpo con una soffice nuvola d'ossigeno grazie al sistema Natural Air



Nuova rubinetteria colore nero (su richiesta)

DIVINA

# DIVINA DUAL



# DIVINA DUAL

VASCA RETTANGOLARE DOPPIA POSTAZIONE

S VERS. SINISTRA

D VERS. DESTRA

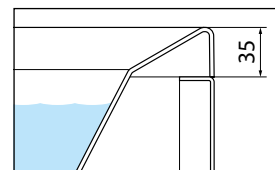
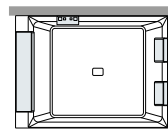
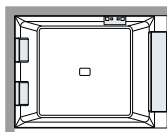

BORDO BASSO - 3,5 CM

Misure	Capacità	Codice	Installazione		Scelta rubinetteria + finitura vasca				Scelta struttura pannelli	
			Destra	Sinistra	Colonna di scarico senza rubinetteria		Colonna di scarico + rubinetteria bordo vasca		Solo struttura	Con pannelli
Cm	H	Lt.								

STANDARD CON TELAIO																			
					D	S	Ø-A	Ø-U	2-A	2-U	ØK	* Vedi tabella SCELTA NUMERO PANNELLI + FINITURA PANNELLI							
	190x140	63	650	<b>DI219014</b>	D	S	4.200 €	4.332 €				5.500 €	5.632 €						
In nicchia con rubinetteria	190x140	63	650	<b>DI219N14</b>	D	S	-	-											
WHIRLPOOL CON TELAIO																			
					D	S	Ø-A	Ø-U	2-A	2-U	ØK	* Vedi tabella SCELTA NUMERO PANNELLI + FINITURA PANNELLI							
	190x140	63	650	<b>DI5190140</b>	D	S	6.300 €	6.432 €				7.600 €	7.732 €						
In nicchia con rubinetteria	190x140	63	650	<b>DI519N140</b>	D	S	-	-											
WHIRLPOOL + AIRPOOL CON TELAIO																			
					D	S	Ø-A	Ø-U	2-A	2-U	ØK	* Vedi tabella SCELTA NUMERO PANNELLI + FINITURA PANNELLI							
	190x140	63	650	<b>DI4190140</b>	D	S	8.400 €	8.532 €				9.700 €	9.832 €						
In nicchia con rubinetteria	190x140	63	650	<b>DI419N140</b>	D	S	-	-											
WHIRLPOOL + CASCATA CON TELAIO																			
					D	S	Ø-A	Ø-U	2-A	2-U	ØK	* Vedi tabella SCELTA NUMERO PANNELLI + FINITURA PANNELLI							
	190x140	63	650	<b>DIW190140</b>	D	S	8.925 €	9.057 €				10.225 €	10.357 €						
In nicchia con rubinetteria	190x140	63	650	<b>DIW19N140</b>	D	S	-	-											
WHIRLPOOL + NATURAL AIR CON TELAIO																			
					D	S	Ø-A	Ø-U	2-A	2-U	ØK	* Vedi tabella SCELTA NUMERO PANNELLI + FINITURA PANNELLI							
	190x140	63	650	<b>DIN190140</b>	D	S	9.713 €	9.844 €				11.013 €	11.144 €						
In nicchia con rubinetteria	190x140	63	650	<b>DIN19N140</b>	D	S	-	-											
WHIRLPOOL + NATURAL AIR + CASCATA CON TELAIO																			
					D	S	Ø-A	Ø-U	2-A	2-U	ØK	* Vedi tabella SCELTA NUMERO PANNELLI + FINITURA PANNELLI							
	190x140	63	650	<b>DIP190140</b>	D	S	11.025 €	11.157 €				12.325 €	12.457 €						
In nicchia con rubinetteria	190x140	63	650	<b>DIP19N140</b>	D	S	-	-											



RUBINETTERIA IN COLORE NERO SU RICHIESTA: + € 219

PER TUTTI GLI OPTIONAL VEDI PAG. 553-554

Scelta numero pannelli				Scelta finitura pannelli /prezzo					
				LAMINATO		LEGNI			
1 frontale	1 frontale + 1 laterale	1 frontale + 2 laterali	2 frontali + 2 laterali	Bianco Lucido	Bianco Opaco	Bianco rigato	Grain	Burlington	Dolomite
<b>1</b>	<b>2</b>	<b>3</b>	<b>4</b>	<b>A</b>	<b>U</b>	<b>I</b>	<b>M</b>	<b>N</b>	<b>X</b>
	-	-	-	+ 525 €	+ 552 €	+ 592 €			
-		-	-	+ 867 €	+ 919 €	+ 985 €			
-	-		-	+ 1.155 €	+ 1.222 €	+ 1.313 €			
-	-	-		+ 1.733 €	+ 1.838 €	+ 1.969 €			

Costruzione codice vasca senza pannelli **Codice** + **Scelta scarico/erogazione + Finitura vasca** + **Scelta struttura senza pannelli** = Codice prodotto finale

Costruzione codice vasca con pannelli **Codice** + **Scelta scarico/erogazione + Finitura vasca** + **Scelta struttura con pannelli (acrilico o legni)** = Codice prodotto finale

**PER LA VERSIONE CON I PANNELLI IN FINITURA ARGILLA/FRAME ORDINARE: 1 CODICE VASCA SOLO STRUTTURA + 1 CODICE PANNELLI ARGILLA/FRAME (QUI SOTTO)**

Installazione vedi pag. 562, 563	Scelta numero pannelli	Scelta finitura pannelli /prezzo					Scelta con FRAME	Scelta finitura pannelli /prezzo										
		ARGILLA			MDI			LEGNI						ARGILLA		MDI		
	1 frontale	Cenere	Polvere	Tortora	Umbra	Sabbia	Nero opaco	Bianco opaco	Bianco Opaco*	Bianco rigato	Grain	Burlington	Dolomite	Cenere	Polvere	Tortora	Umbra	Sabbia
	<b>1</b>	<b>R</b>	<b>O</b>	<b>S</b>	<b>1</b>	<b>2</b>	<b>H</b>	<b>U</b>	<b>U</b>	<b>I</b>	<b>M</b>	<b>N</b>	<b>X</b>	<b>R</b>	<b>O</b>	<b>S</b>	<b>1</b>	<b>2</b>
	<b>PANV1FDI19D-</b>	950 €			1.030 €		709 €						1.353 €		1.353 €			
	1 frontale + 1 laterale	Cenere	Polvere	Tortora	Umbra	Sabbia	Nero opaco	Bianco opaco	Bianco Opaco*	Bianco rigato	Grain	Burlington	Dolomite	Cenere	Polvere	Tortora	Umbra	Sabbia
	<b>2</b>	<b>R</b>	<b>O</b>	<b>S</b>	<b>1</b>	<b>2</b>	<b>H</b>	<b>U</b>	<b>U</b>	<b>I</b>	<b>M</b>	<b>N</b>	<b>X</b>	<b>R</b>	<b>O</b>	<b>S</b>	<b>1</b>	<b>2</b>
	<b>PANV1F1LDI19914-</b>	1.950 €			2.029 €		-						-		-			
	Destra <b>PANV1F1LDI1991D-</b>	-			-		1.610 €						2.673 €		2.673 €			
	Sinistra <b>PANV1F1LDI1991S-</b>	-			-		-						-		-			
	1 frontale + 2 laterali	Cenere	Polvere	Tortora	Umbra	Sabbia	Nero opaco	Bianco opaco	Bianco Opaco*	Bianco rigato	Grain	Burlington	Dolomite	Cenere	Polvere	Tortora	Umbra	Sabbia
	<b>3</b>	<b>R</b>	<b>O</b>	<b>S</b>	<b>1</b>	<b>2</b>	<b>H</b>	<b>U</b>	<b>U</b>	<b>I</b>	<b>M</b>	<b>N</b>	<b>X</b>	<b>R</b>	<b>O</b>	<b>S</b>	<b>1</b>	<b>2</b>
	<b>PANV1F2LDI19914-</b>	2.550 €			2.640 €		-						-		-			
	Destra <b>PANV1F2LDI1991D-</b>	-			2.640 €		2.575 €						2.833 €		2.833 €			
	Sinistra <b>PANV1F2LDI1991S-</b>	-			-		-						-		-			
	2 frontali + 2 laterali	Cenere	Polvere	Tortora	Umbra	Sabbia	Nero opaco	Bianco opaco	Bianco Opaco*	Bianco rigato	Grain	Burlington	Dolomite	Cenere	Polvere	Tortora	Umbra	Sabbia
	<b>4</b>	<b>R</b>	<b>O</b>	<b>S</b>	<b>1</b>	<b>2</b>	<b>H</b>	<b>U</b>	<b>U</b>	<b>I</b>	<b>M</b>	<b>N</b>	<b>X</b>	<b>R</b>	<b>O</b>	<b>S</b>	<b>1</b>	<b>2</b>
	<b>PANV2F2LDI19914-</b>	3.900 €			4.057 €		2.962 €						5.344 €		5.344 €			

\* LA FINITURA DI PANNELLO BIANCO OPACO È DISPONIBILE SOLO CON FRAME NERO OPACO

**COLORI SPECIALI SU RICHIESTA PER PANNELLI ARGILLA**

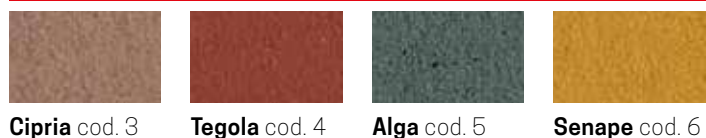

PANNELLI	Prezzo
1-2 pannelli	+190 €
3-4 pannelli	+380 €



## DIVINA F | FINITURE PANNELLI

### PANNELLI



Bianco lucido

Bianco morbido

## DIVINA F | FUNZIONI E DOTAZIONI (disponibili a seconda dell'allestimento)

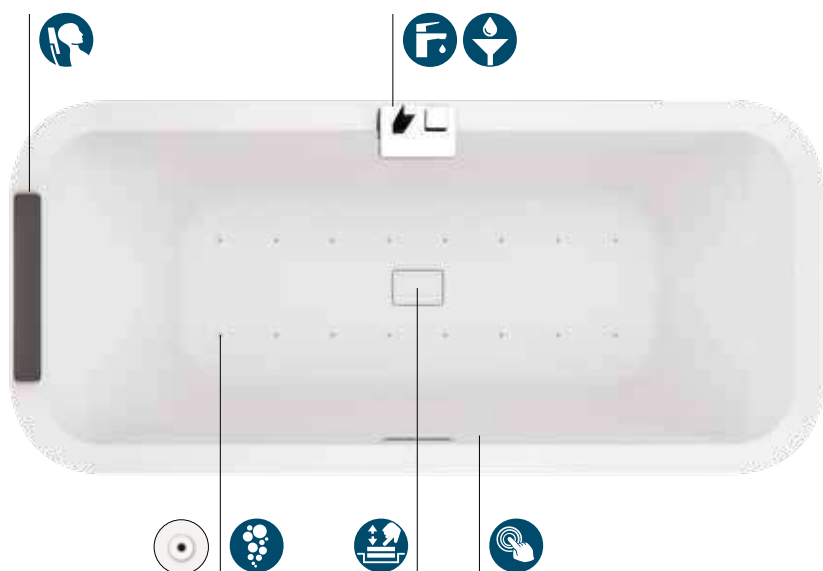

**Massaggio Airpool (16 jets)** a getto d'aria con accensione manuale on/off. Per una **efficace stimolazione cellulare**.



**Accensione soft-touch.**



**Poggiatesta** in materiale antibatterico.



**Rubinetteria bordo vasca** con cascata e tubo di scarico salvagoccia.



**Colonna di scarico con piletta** click-clack.





DIVINA



L' Idromassaggio Airpool ossigena e rigenera le cellule la pelle



Anello con mensola e porta salviette in acciaio inox



Rubinetteria bordo vasca con tubo di scarico salvagoccia



Accensione soft-touch con comando capacitivo sul bordo della vasca

# DIVINA F



# DIVINA F

VASCA CENTRO STANZA

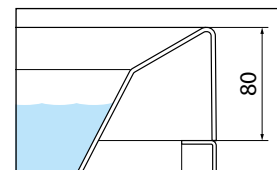

BORDO ALTO - 8 CM



Misure		Capacità	Codice	Scelta rubinetteria + finitura vasca			
Cm	H	Lt.		Colonna di scarico senza rubinetteria		Colonna di scarico + rubinetteria bordo vasca	
				Bianco lucido	Bianco morbido	Bianco lucido	Bianco morbido
<b>STANDARD DA INCASSO</b>							
180 x 80	63	300	<b>DI11808C</b>	<b>-A</b> 1.090 €	<b>-U</b> 1.188 €	<b>2-A0K</b> 1.845 €	<b>2-U0K</b> 1.943 €
<b>STANDARD CON TELAIO</b>							
180 x 80	63	300	<b>DI21808C</b>	<b>-A1A</b> 3.787 €	<b>-U1U</b> 3.884 €	<b>2-A1A</b> 4.528 €	<b>2-U1U</b> 4.625 €
<b>HYDRO AIR</b>							
180 x 80	63	300	<b>DIY1808CO</b>	<b>0-A1A</b> 5.125 €	<b>0-U1U</b> 5.223 €	<b>2-A1A</b> 5.867 €	<b>2-U1U</b> 5.964 €

PER TUTTI GLI OPTIONAL VEDI PAG. 553-554



# DIVINA F B35

VASCA CENTRO STANZA, VERSIONE BORDO 3,5 CM

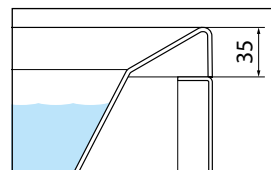

BORDO BASSO - 3,5 CM



Misure		Capacità	Codice	Scelta rubinetteria + finitura vasca			
Cm	H	Lt.		Colonna di scarico senza rubinetteria		Colonna di scarico + rubinetteria bordo vasca	
				Bianco lucido	Bianco morbido	Bianco lucido	Bianco morbido
<b>STANDARD DA INCASSO</b>							
180 x 80	63	300	<b>DI11898C</b>	<b>-A</b>	<b>-U</b>	<b>2-A0K</b>	<b>2-U0K</b>
				1.090 €	1.188 €	1.845 €	1.943 €

DIVINA

PER TUTTI GLI OPTIONAL VEDI PAG. 553-554



VASCA BIANCO MORBIDO CON PANNELLO BURLINGTON



VASCA BIANCO MORBIDO CON PANNELLO BIANCO MORBIDO

## DIVINA C | FINITURE PANNELLI

### ACRILICO



Bianco lucido

Bianco morbido

### ARGILLA

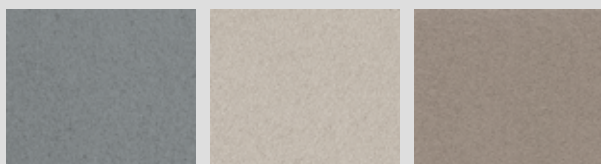

Cenere

Polvere

Tortora

### LEGNO

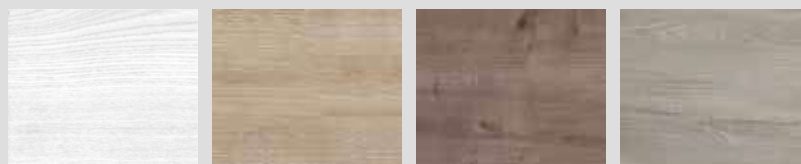

Bianco rigato

Grain

Burlington

Dolomite

## DIVINA C | FUNZIONI E DOTAZIONI (disponibili a seconda dell'allestimento)



**Massaggio Airpool (16 jets)** a getto d'aria con accensione manuale on/off. Per una **efficace stimolazione cellulare**.



**Massaggio corpo Whirlpool (6 jets)** aria/acqua. Per soddisfare qualsiasi esigenza di benessere.



**Natural air**



**Cromolight** con 8 variazioni cromatiche per attivare la mente ed emozionare lo spirito.



**Accensione soft-touch.**



**Poggiatesta** in materiale antibatterico.



**Rubinetteria bordo vasca** con cascata e tubo di scarico salvagoccia.



**Colonna di scarico con piletta** click-clack.



VASCA BIANCO MORBIDO CON PANNELLO ARGILLA CENERE

DIVINA



Rubinetto

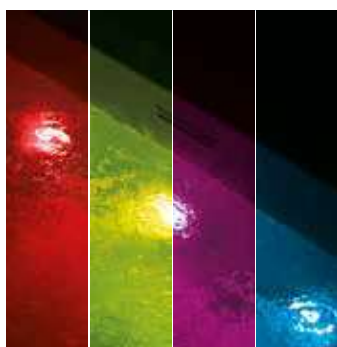

Bocchette Whirlpool con Cromolight integrata per stimolare corpo ed emozioni



Avvolgere il corpo con una soffice nuvola d'ossigeno grazie al sistema Natural Air



Accensione soft-touch con comando capacitivo sul bordo della vasca



# DIVINA C

# DIVINA C

## VASCA ANGOLARE SIMMETRICA SEMICIRCOLARE

Design Massimo Farinatti

Misure		Capacità	Codice	Scelta rubinetteria + finitura vasca						Scelta struttura / Pannello	
Cm	H	Lt.		Colonna di scarico senza rubinetteria		Colonna di scarico con erogazione da troppo pieno		Colonna di scarico + rubinetteria bordo vasca		Senza pannelli	Con pannelli
				Bianco lucido	Bianco morbido	Bianco lucido	Bianco morbido	Bianco lucido	Bianco morbido		
<b>STANDARD DA INCASSO</b>											
				<b>0-A</b>	<b>0-U</b>	<b>1-A</b>	<b>1-U</b>	<b>2-A</b>	<b>2-U</b>		
140 X140	63	400	<b>DI1140149</b>	1.090 €	1.188 €	1.160 €	1.258 €	1.845 €	1.943 €		
<b>STANDARD CON TELAIO</b>											
				<b>0-A</b>	<b>0-U</b>	<b>1-A</b>	<b>1-U</b>	<b>2-A</b>	<b>2-U</b>	<b>0K</b>	* Vedi tabella <b>SCELTA FINITURA PANNELLO</b>
140 X140	63	400	<b>DI2140149</b>	1.454 €	1.552 €	1.523 €	1.620 €	2.195 €	2.293 €		
<b>HYDRO AIR</b>											
				<b>0-A</b>	<b>0-U</b>	<b>1-A</b>	<b>1-U</b>	<b>2-A</b>	<b>2-U</b>	<b>0K</b>	* Vedi tabella <b>SCELTA FINITURA PANNELLO</b>
140 X140	63	400	<b>DIY1401490</b>	2.254 €	2.352 €	2.323 €	2.420 €	2.995 €	3.093 €		
<b>WHIRLPOOL</b>											
				<b>0-A</b>	<b>0-U</b>	<b>1-A</b>	<b>1-U</b>	<b>2-A</b>	<b>2-U</b>	<b>0K</b>	* Vedi tabella <b>SCELTA FINITURA PANNELLO</b>
140 X140	63	400	<b>DI51401490</b>	2.480 €	2.578 €	2.549 €	2.647 €	3.222 €	3.319 €		
<b>HYDRO PLUS</b>											
				<b>0-A</b>	<b>0-U</b>	<b>1-A</b>	<b>1-U</b>	<b>2-A</b>	<b>2-U</b>	<b>0K</b>	* Vedi tabella <b>SCELTA FINITURA PANNELLO</b>
140 X140	63	400	<b>DI41401490</b>	4.347 €	4.444 €	4.415 €	4.513 €	5.088 €	5.185 €		
<b>NATURAL AIR</b>											
				<b>0-A</b>	<b>0-U</b>	<b>1-A</b>	<b>1-U</b>	<b>2-A</b>	<b>2-U</b>	<b>0K</b>	* Vedi tabella <b>SCELTA FINITURA PANNELLO</b>
140 X140	63	400	<b>DIN1401490</b>	3.175 €	3.273 €	3.244 €	3.342 €	3.917 €	4.014 €		
<b>NATURAL AIR + HYDRO</b>											
				<b>0-A</b>	<b>0-U</b>	<b>1-A</b>	<b>1-U</b>	<b>2-A</b>	<b>2-U</b>	<b>0K</b>	* Vedi tabella <b>SCELTA FINITURA PANNELLO</b>
140 X140	63	400	<b>DIP1401490</b>	5.105 €	5.203 €	5.174 €	5.272 €	5.847 €	5.944 €		

**RUBINETTERIA IN COLORE NERO SU RICHIESTA: + € 125**

**PER TUTTI GLI OPTIONAL VEDI PAG. 553-554**



VASCA BIANCO MORBIDO CON PANNELLO ARGILLA POLVERE

	Scelta finitura pannelli /prezzo								
	ACRILICO		LEGNI				ARGILLA		
	1 pannello finitura vasca bianco lucido	1 pannello finitura vasca bianco morbido	Bianco rigato	Grain	Burlington	Dolomite	Cenere	Polvere	Tortora
	<b>1A</b>	<b>1U</b>	<b>1I</b>	<b>1M</b>	<b>1N</b>	<b>1X</b>	<b>1R</b>	<b>10</b>	<b>1S</b>
	+ 452 €		+ 799 €				+ 1.095 €		

DIVINA

**COLORI SPECIALI SU RICHIESTA PER PANNELLI ARGILLA**

				<b>PANNELLI</b>	<b>Prezzo</b>
<b>Cipria</b> cod. 3	<b>Tegola</b> cod. 4	<b>Alga</b> cod. 5	<b>Senape</b> cod. 6	1 pannello	+125 €

Costruzione codice vasca senza pannelli **Codice** + **Scelta scarico/erogazione + Finitura vasca** + **Scelta struttura senza pannelli** = Codice prodotto finale

Costruzione codice vasca con pannelli **Codice** + **Scelta scarico/erogazione + Finitura vasca** + **Scelta struttura con pannelli (acrilico o legni)** = Codice prodotto finale



VASCA BIANCO MORBIDO CON PANNELLO ARGILLA TORTORA



VASCA BIANCO MORBIDO CON PANNELLO BIANCO MORBIDO

## DIVINA O | FINITURE PANNELLI

### ACRILICO



Bianco lucido

Bianco morbido

### ARGILLA

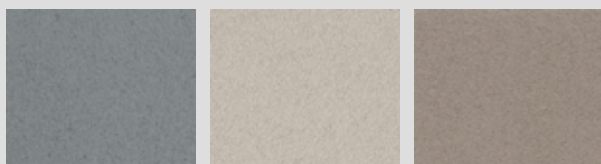

Cenere

Polvere

Tortora

### LEGNO

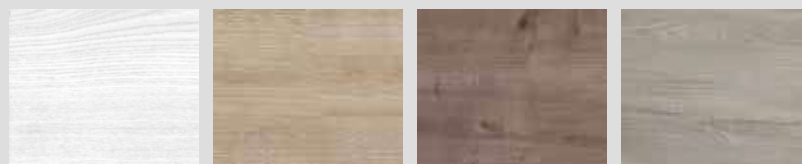

Bianco rigato

Grain

Burlington

Dolomite

## DIVINA O | FUNZIONI E DOTAZIONI (disponibili a seconda dell'allestimento)



**Massaggio Airpool (16 jets)** a getto d'aria con accensione manuale on/off. Per una **efficace stimolazione cellulare**.



**Massaggio corpo Whirlpool (6 jets)** aria/acqua. Per soddisfare qualsiasi esigenza di benessere.



**Natural air**



**Cromolight** con 8 variazioni cromatiche per attivare la mente ed emozionare lo spirito.



**Accensione soft-touch.**



**Poggiatesta** in materiale antibatterico.



**Rubinetteria bordo vasca** con cascata e tubo di scarico salvagoccia.



**Colonna di scarico con piletta** click-clack.



VASCA BIANCO MORBIDO CON PANNELLO BURLINGTON

DIVINA



Rubinetto

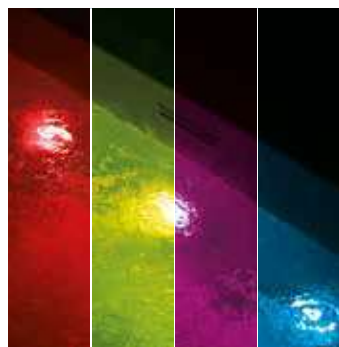

Bocchette Whirlpool con Cromolight integrata per stimolare corpo ed emozioni



Avvolgere il corpo con una soffice nuvola d'ossigeno grazie al sistema Natural Air



Accensione soft-touch con comando capacitivo sul bordo della vasca



# DIVINA 0

# DIVINA 0

**VASCA ANGOLARE ASIMMETRICA**  
Design Massimo Farinatti

**S** VERS. SINISTRA

**D** VERS. DESTRA

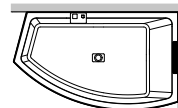
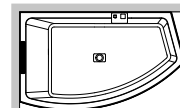

Misure			Capacità	Codice	Installazione		Scelta rubinetteria + finitura vasca						Scelta struttura / Pannello	
Cm	H	Lt.			Destra	Sinistra	Colonna di scarico senza rubinetteria		Colonna di scarico con erogazione da troppo pieno		Colonna di scarico + rubinetteria bordo vasca		Senza pannelli	Con pannelli
					D	S	0-A	0-U	1-A	1-U	2-A	2-U	0K	
<b>STANDARD DA INCASSO</b>														
165 X 98	63	360	<b>DI116599</b>				1.020 €	1.118 €	1.090 €	1.188 €	1.775 €	1.873 €		-
<b>STANDARD CON TELAIO</b>														
165 X 98	63	360	<b>DI216599</b>				1.388 €	1.485 €	1.457 €	1.554 €	2.129 €	2.227 €		* Vedi tabella <b>SCELTA FINITURA PANNELLO</b>
<b>HYDRO AIR</b>														
165 X 98	63	360	<b>DIY165990</b>				2.187 €	2.284 €	2.255 €	2.353 €	2.928 €	3.025 €		* Vedi tabella <b>SCELTA FINITURA PANNELLO</b>
<b>WHIRLPOOL</b>														
165 X 98	63	360	<b>DI5165990</b>				2.414 €	2.512 €	2.483 €	2.580 €	3.155 €	3.253 €		* Vedi tabella <b>SCELTA FINITURA PANNELLO</b>
<b>HYDRO PLUS</b>														
165 X 98	63	360	<b>DI4165990</b>				4.279 €	4.377 €	4.348 €	4.445 €	5.020 €	5.118 €		* Vedi tabella <b>SCELTA FINITURA PANNELLO</b>
<b>NATURAL AIR</b>														
165 X 98	63	360	<b>DIN165990</b>				3.109 €	3.207 €	3.178 €	3.275 €	3.850 €	3.948 €		* Vedi tabella <b>SCELTA FINITURA PANNELLO</b>
<b>NATURAL AIR + HYDRO</b>														
165 X 98	63	360	<b>DIP165990</b>				5.039 €	5.137 €	5.108 €	5.205 €	5.780 €	5.878 €		* Vedi tabella <b>SCELTA FINITURA PANNELLO</b>



**RUBINETTERIA IN COLORE NERO SU RICHIESTA: + € 125**

PER TUTTI GLI OPTIONAL VEDI PAG. 553-554





VASCA BIANCO MORBIDO CON PANNELLO BIANCO RIGATO

	Scelta finitura pannelli /prezzo								
	ACRILICO		LEGNI				ARGILLA		
	1 pannello finitura vasca bianco lucido	1 pannello finitura vasca bianco morbido	Bianco rigato	Grain	Burlington	Dolomite	Cenere	Polvere	Tortora
	<b>1A</b>	<b>1U</b>	<b>1I</b>	<b>1M</b>	<b>1N</b>	<b>1X</b>	<b>1R</b>	<b>1O</b>	<b>1S</b>
	+ 452 €		+ 799 €				+ 1.095 €		

**COLORI SPECIALI SU RICHIESTA PER PANNELLI ARGILLA**

				<b>PANNELLI</b>	<b>Prezzo</b>
<b>Cipria</b> cod. 3	<b>Tegola</b> cod. 4	<b>Alga</b> cod. 5	<b>Senape</b> cod. 6	1 pannello	+125 €

Costruzione codice vasca senza pannelli **Codice** + **Scelta scarico/erogazione + Finitura vasca** + **Scelta struttura senza pannelli** = Codice prodotto finale

Costruzione codice vasca con pannelli **Codice** + **Scelta scarico/erogazione + Finitura vasca** + **Scelta struttura con pannelli (acrilico o legni)** = Codice prodotto finale

DIVINA



VERSIONE CENTRO PARETE - FINITURA PANNELLO BIANCO MORBIDO



VERSIONE AD ANGOLO - FINITURA PANNELLO DOLOMITE

## DIVINA W | FINITURE PANNELLI

### ACRILICO



Bianco lucido

Bianco morbido

### LEGNO

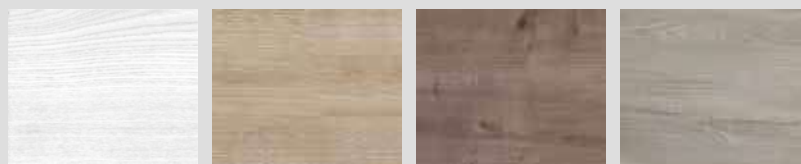

Bianco rigato

Grain

Burlington

Dolomite

### ARGILLA

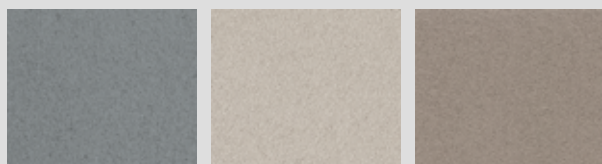

Cenere

Polvere

Tortora

## DIVINA W | FUNZIONI E DOTAZIONI (disponibili a seconda dell'allestimento)



**Massaggio Airpool (16 jets)** a getto d'aria con accensione manuale on/off. Per una **efficace stimolazione cellulare**.



**Massaggio corpo Whirlpool (6 jets)** aria/acqua. Per soddisfare qualsiasi esigenza di benessere.



**Natural air**



**Cromolight** con 8 variazioni cromatiche per attivare la mente ed emozionare lo spirito.



**Accensione soft-touch.**



**Poggiatesta** in materiale antibatterico.



**Rubinetteria bordo vasca** con cascata e tubo di scarico salvagoccia.



**Colonna di scarico con piletta** click-clack.



VERSIONE AD ANGOLO - FINITURA PANNELLO CENERE



Avvolgere il corpo con una soffice nuvola d'ossigeno grazie al sistema Natural Air

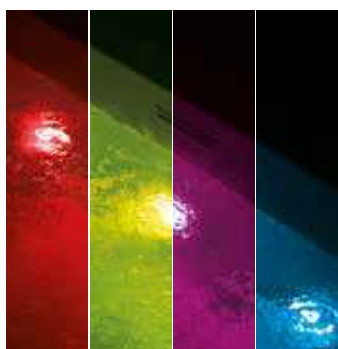

Bocchette Whirlpool con Cromolight integrata per stimolare corpo ed emozioni



Accensione soft-touch con comando capacitivo sul bordo della vasca



Rubinetto







































DIVINA

# DIVINA W

# DIVINA W

## VASCA RETTANGOLARE

Misure			Capacità	Codice	Scelta rubinetteria + finitura vasca						Scelta struttura / Pannello	
Cm	H	Lt.			Colonna di scarico senza rubinetteria		Colonna di scarico con erogazione da troppo pieno		Colonna di scarico + rubinetteria bordo vasca		Senza pannelli	Con pannelli
					Bianco lucido	Bianco morbido	Bianco lucido	Bianco morbido	Bianco lucido	Bianco morbido		

STANDARD DA INCASSO																		
					0-A	0-U	1-A	1-U	2-A	2-U	0K							
180 X 80	63	320	<b>DI11808W</b>		1.079 €	1.177 €	1.149 €	1.247 €	1.820 €	1.918 €								
STANDARD CON TELAIO																		
180 X 80	63	320	<b>DI21808W</b>		1.458 €	1.555 €	1.528 €	1.625 €	2.199 €	2.297 €		* Vedi tabella <b>SCELTA FINITURA PANNELLO</b>						
HYDRO AIR																		
180 X 80	63	320	<b>DIY1808WO</b>		2.743 €	2.840 €	2.813 €	2.910 €	3.484 €	3.582 €		* Vedi tabella <b>SCELTA FINITURA PANNELLO</b>						
WHIRLPOOL																		
180 X 80	63	320	<b>DI51808WO</b>		3.027 €	3.124 €	3.097 €	3.194 €	3.768 €	3.865 €		* Vedi tabella <b>SCELTA FINITURA PANNELLO</b>						
HYDRO PLUS																		
180 X 80	63	320	<b>DI41808WO</b>		5.367 €	5.464 €	5.437 €	5.534 €	6.108 €	6.205 €		* Vedi tabella <b>SCELTA FINITURA PANNELLO</b>						
NATURAL AIR																		
180 X 80	63	320	<b>DIN1808WO</b>		3.899 €	3.997 €	3.969 €	4.067 €	4.640 €	4.738 €		* Vedi tabella <b>SCELTA FINITURA PANNELLO</b>						
NATURAL AIR + WHIRLPOOL																		
180 X 80	63	320	<b>DIP1808WO</b>		6.322 €	6.419 €	6.392 €	6.489 €	7.063 €	7.160 €		* Vedi tabella <b>SCELTA FINITURA PANNELLO</b>						

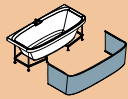
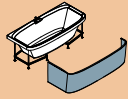
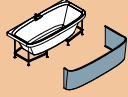

VERSIONE CENTRO PARETE - FINITURA PANNELLO BURLINGTON

Scelta numero pannelli	Scelta finitura pannelli /prezzo								
	ACRILICO		LEGNI				ARGILLA		
	Bianco Lucido	Bianco morbido	Bianco rigato	Grain	Burlington	Dolomite	Cenere	Polvere	Tortora
1 pannello centro parete	<b>CA</b>	<b>CU</b>	<b>CI</b>	<b>CM</b>	<b>CN</b>	<b>CX</b>	<b>CR</b>	<b>CO</b>	<b>CS</b>
	+ 563 €	+ 675 €	+ 912 €				+ 1.208 €		
1 pannello angolo destro	<b>DA</b>	<b>DU</b>	<b>DI</b>	<b>DM</b>	<b>DN</b>	<b>DX</b>	<b>DR</b>	<b>DO</b>	<b>DS</b>
	+ 563 €	+ 675 €	+ 912 €				+ 1.208 €		
1 pannello angolo sinistro	<b>SA</b>	<b>SU</b>	<b>SI</b>	<b>SM</b>	<b>SN</b>	<b>SX</b>	<b>SR</b>	<b>SO</b>	<b>SS</b>
	+ 563 €	+ 675 €	+ 912 €				+ 1.208 €		

Costruzione codice vasca senza pannelli **Codice** + **Scelta scarico/erogazione + Finitura vasca** + **Scelta struttura senza pannelli** = Codice prodotto finale

Costruzione codice vasca con pannelli **Codice** + **Scelta scarico/erogazione + Finitura vasca** + **Scelta struttura con pannelli (laminato o argilla)** = Codice prodotto finale



**RUBINETTERIA IN COLORE NERO SU RICHIESTA: + € 125**

**COLORI SPECIALI SU RICHIESTA PER PANNELLI ARGILLA**



**Cipria** cod. 3



**Tegola** cod. 4



**Alga** cod. 5



**Senape** cod. 6

PANNELLI	Prezzo
1 pannello angolo	+125 €
1 pannello centro parete	+250 €



VASCA BIANCO MORBIDO CON PANNELLI ARGILLA TORTORA



VASCA BIANCO MORBIDO CON PANNELLI BURLINGTON + FRAME BIANCO

## DIVINA | FINITURE PANNELLI

### ACRILICO



Bianco  
lucido

Bianco  
morbido

### LEGNO



Bianco  
rigato

Grain

Burlington

Dolomite

### ARGILLA

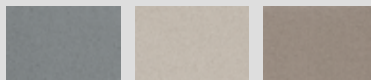

Cenere

Polvere

Tortora

### MDI



Umbra

Sabbia

### FRAME ALLUMINIO NERO OPACO



Bianco  
morbido

### LEGNO



Bianco  
rigato

Grain

Burlington

Dolomite

### ARGILLA

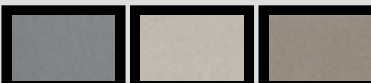

Cenere

Polvere

Tortora

### MDI



Umbra

Sabbia

### FRAME ALLUMINIO BIANCO OPACO

### LEGNO

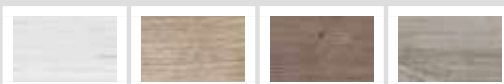

Bianco  
rigato

Grain

Burlington

Dolomite

### ARGILLA

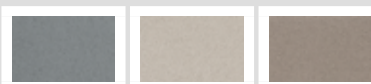

Cenere

Polvere

Tortora

### MDI

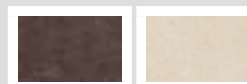

Umbra

Sabbia

## DIVINA | FUNZIONI E DOTAZIONI (disponibili a seconda dell'allestimento)



**Massaggio Airpool (16 jets)** a getto d'aria con accensione manuale on/off. Per una **efficace stimolazione cellulare**.



**Massaggio corpo Whirlpool (6 jets)** aria/acqua. Per soddisfare qualsiasi esigenza di benessere.



**Natural air**



**Cromolight** con 8 variazioni cromatiche per attivare la mente ed emozionare lo spirito.



**Accensione soft-touch.**



**Poggiatesta** in materiale antibatterico.



**Rubinetteria bordo vasca** con cascata e tubo di scarico salvagoccia.



**Colonna di scarico con piletta** click-clack.



VASCA BIANCO MORBIDO CON PANNELLI BIANCO MORBIDO



Avvolgere il corpo con una soffice nuvola d'ossigeno grazie al sistema Natural Air

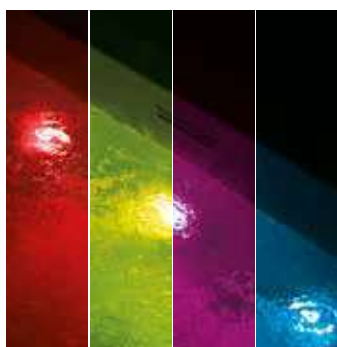

Bocchette Whirlpool con Cromolight integrata per stimolare corpo ed emozioni



Accensione soft-touch con comando capacitivo sul bordo della vasca



**OPTIONAL**  
**SOPRAVASCA DIVINA**  
vedi pag. 586, 588

DIVINA

# DIVINA



# DIVINA

## VASCA RETTANGOLARE - BORDO BASSO - 3,5 CM

Design Massimo Farinatti

Misure			Capacità	Codice	Scelta rubinetteria + finitura vasca						Scelta struttura/pannelli	
Cm	H	Lt.			Colonna di scarico senza rubinetteria		Colonna di scarico con erogazione da troppo pieno		Colonna di scarico + rubinetteria bordo vasca		Solo struttura	Con pannelli
					Bianco lucido	Bianco morbido	Bianco lucido	Bianco morbido	Bianco lucido	Bianco morbido		

STANDARD DA INCASSO											
				-A	-U	1-A0K	1-U0K	2-A0K	2-U0K		
160 x 70	63	250	<b>DI116970</b>	814 €	912 €	884 €	982 €	1.569 €	1.667 €		
170 x 70	63	280	<b>DI117970</b>								
170 x 75	63	300	<b>DI117975</b>								
180 x 80	63	350	<b>DI118980</b>	1.090 €	1.188 €	1.160 €	1.258 €	1.845 €	1.943 €		
180 x 100	63	430	<b>DI118910</b>								
190 x 90	63	420	<b>DI119990</b>								

STANDARD CON TELAIO											
				-A	-U	1-A	1-U	2-A	2-U	0K	* Vedi tabella <b>SCelta            NUMERO            PANNELLI            +FINITURA            PANNELLI</b>
160 x 70	63	250	<b>DI216970</b>	1.039 €	1.137 €	1.108 €	1.205 €	1.780 €	1.878 €		
170 x 70	63	280	<b>DI217970</b>								
170 x 75	63	300	<b>DI217975</b>								
180 x 80	63	350	<b>DI218980</b>	1.302 €	1.399 €	1.370 €	1.468 €	2.043 €	2.140 €		
180 x 100	63	430	<b>DI218910</b>								
190 x 90	63	420	<b>DI219990</b>								

HYDRO AIR											
				0-A	0-U	1-A	1-U	2-A	2-U	0K	* Vedi tabella <b>SCelta            NUMERO            PANNELLI            +FINITURA            PANNELLI</b>
160 x 70	63	250	<b>DIY169700</b>	2.339 €	2.437 €	2.408 €	2.505 €	3.080 €	3.178 €		
170 x 70	63	280	<b>DIY179700</b>								
170 x 75	63	300	<b>DIY179750</b>								
180 x 80	63	350	<b>DIY189800</b>	2.602 €	2.699 €	2.670 €	2.768 €	3.343 €	3.440 €		
180 x 100	63	430	<b>DIY189100</b>								
190 x 90	63	420	<b>DIY199900</b>								

WHIRLPOOL											
				0-A	0-U	1-A	1-U	2-A	2-U	0K	* Vedi tabella <b>SCelta            NUMERO            PANNELLI            +FINITURA            PANNELLI</b>
160 x 70	63	250	<b>DI5169700</b>	2.562 €	2.659 €	2.630 €	2.728 €	3.303 €	3.400 €		
170 x 70	63	280	<b>DI5179700</b>								
170 x 75	63	300	<b>DI5179750</b>								
180 x 80	63	350	<b>DI5189800</b>	2.824 €	2.922 €	2.893 €	2.990 €	3.565 €	3.663 €		
180 x 100	63	430	<b>DI5189100</b>								
190 x 90	63	420	<b>DI5199900</b>								

HYDRO PLUS											
				0-A	0-U	1-A	1-U	2-A	2-U	0K	* Vedi tabella <b>SCelta            NUMERO            PANNELLI            +FINITURA            PANNELLI</b>
160 x 70	63	250	<b>DI4169700</b>	4.400 €	4.498 €	4.469 €	4.567 €	5.142 €	5.239 €		
170 x 70	63	280	<b>DI4179700</b>								
170 x 75	63	300	<b>DI4179750</b>								
180 x 80	63	350	<b>DI4189800</b>	4.663 €	4.760 €	4.732 €	4.829 €	5.404 €	5.502 €		
180 x 100	63	430	<b>DI4189100</b>								
190 x 90	63	420	<b>DI4199900</b>								

**RUBINETTERIA IN COLORE NERO SU RICHIESTA: + € 125**



Misure		Capacità	Codice	Scelta rubinetteria + finitura vasca				Scelta struttura/pannelli			
<b>Cm</b>	<b>H</b>	<b>Lt.</b>									
				Bianco lucido	Bianco morbido	Bianco lucido	Bianco morbido	Bianco lucido	Bianco morbido	Solo struttura	Con pannelli

NATURAL AIR											
				0-A	0-U	1-A	1-U	2-A	2-U	0K	* Vedi tabella <b>SCELTA NUMERO PANNELLI +FINITURA PANNELLI</b>
160 x 70	63	250	<b>DIN169700</b>	3.257 €	3.354 €	3.325 €	3.423 €	3.998 €	4.095 €		
170 x 70	63	280	<b>DIN179700</b>								
170 x 75	63	300	<b>DIN179750</b>								
180 x 80	63	350	<b>DIN189800</b>	3.519 €	3.617 €	3.588 €	3.685 €	4.260 €	4.358 €		
180 x 100	63	430	<b>DIN189100</b>								
190 x 90	63	420	<b>DIN199900</b>								

NATURAL AIR + WHIRLPOOL											
				0-A	0-U	1-A	1-U	2-A	2-U	0K	* Vedi tabella <b>SCELTA NUMERO PANNELLI +FINITURA PANNELLI</b>
160 x 70	63	250	<b>DIP169700</b>	5.160 €	5.258 €	5.229 €	5.327 €	5.902 €	5.999 €		
170 x 70	63	280	<b>DIP179700</b>								
170 x 75	63	300	<b>DIP179750</b>								
180 x 80	63	350	<b>DIP189800</b>	5.423 €	5.520 €	5.492 €	5.589 €	6.164 €	6.262 €		
180 x 100	63	430	<b>DIP189100</b>								
190 x 90	63	420	<b>DIP199900</b>								

Scelta numero pannelli				Scelta finitura pannelli / prezzo						
				LAMINATO		LEGNI				
1 frontale	1 frontale + 1 laterale	1 frontale + 2 laterali	2 frontali + 2 laterali	Bianco Lucido	Bianco Opaco	Bianco rigato	Grain	Burlington	Dolomite	
<b>1</b>	<b>2</b>	<b>3</b>	<b>4</b>	<b>A</b>	<b>U</b>	<b>I</b>	<b>M</b>	<b>N</b>	<b>X</b>	
	-	-	-	+ 310 €	+ 329 €	+ 355 €				
-		-	-	+ 452 €	+ 478 €	+ 515 €				
-	-		-	+ 632 €	+ 664 €	+ 715 €				
-	-	-		+ 902 €	+ 954 €	+ 1.030 €				

### SCEGLI ALTRE FINITURE NELLA PAGINA SEGUENTE

Costruzione codice vasca senza pannelli **Codice** + **Scelta scarico/erogazione + Finitura vasca** + **Scelta struttura senza pannelli** = Codice prodotto finale

Costruzione codice vasca con pannelli **Codice** + **Scelta scarico/erogazione + Finitura vasca** + **Scelta struttura con pannelli (acrilico o legni)** = Codice prodotto finale

### COLORI SPECIALI SU RICHIESTA PER PANNELLI ARGILLA

				<b>PANNELLI</b>	<b>Prezzo</b>
				1-2 pannelli	+125 €
				3-4 pannelli	+250 €

**PER LA VERSIONE CON I PANNELLI IN FINITURA ARGILLA/FRAME ORDINARE: 1 CODICE VASCA SOLO STRUTTURA + 1 CODICE PANNELLI ARGILLA/FRAME (QUI SOTTO)**

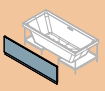
Misure	CODICE	Scelta finitura pannelli				
	Scelta numero pannelli	ARGILLA		MDI		
		Cenere	Polvere	Tortora	Umbr	Sabbia
	1 frontale					
	<b>1</b>	<b>R</b>	<b>O</b>	<b>S</b>	<b>1</b>	<b>2</b>
160 x 70	<b>PANV1FDI169-</b>	877 €			877 €	
170 x 70; 170 x 75	<b>PANV1FDI179-</b>					
180 x 80; 180 x 100	<b>PANV1FDI189-</b>					
190 x 90	<b>PANV1FDI199-</b>					

Finitura FRAME	Scelta finitura pannelli per FRAME											
	FRAME		LEGNI				ARGILLA		MDI			
	Bianco Opaco	Nero Opaco	Bianco Opaco*	Bianco rigato	Grain	Burlington	Dolomite	Cenere	Polvere	Tortora	Umbr	Sabbia
	U	H	U	I	M	N	X	R	O	S	1	2
			677 €				1.038 €		1.038 €			

Misure	CODICE	Scelta numero pannelli	Scelta finitura pannelli				
			ARGILLA		MDI		
			Cenere	Polvere	Tortora	Umbr	Sabbia
		1 frontale + 1 laterale					
		<b>2</b>	<b>R</b>	<b>O</b>	<b>S</b>	<b>1</b>	<b>2</b>
160 x 70	<b>PANV1F1LDI16970-</b>	1.275 €			1.275 €		
170 x 70	<b>PANV1F1LDI17970-</b>						
170 x 75	<b>PANV1F1LDI17975-</b>						
180 x 80	<b>PANV1F1LDI18980-</b>						
180 x 100	<b>PANV1F1LDI18910-</b>						
190 x 90	<b>PANV1F1LDI19990-</b>						

Finitura FRAME	Scelta finitura pannelli per FRAME											
	FRAME		LEGNI				ARGILLA		MDI			
	Bianco Opaco	Nero Opaco	Bianco Opaco*	Bianco rigato	Grain	Burlington	Dolomite	Cenere	Polvere	Tortora	Umbr	Sabbia
	U	H	U	I	M	N	X	R	O	S	1	2
			838 €				1.437 €		1.437 €			

Misure	CODICE	Scelta numero pannelli	Scelta finitura pannelli				
			ARGILLA		MDI		
			Cenere	Polvere	Tortora	Umbr	Sabbia
		1 frontale + 2 laterali					
		<b>3</b>	<b>R</b>	<b>O</b>	<b>S</b>	<b>1</b>	<b>2</b>
160 x 70	<b>PANV1F2LDI16970-</b>	1.713 €			1.713 €		
170 x 70	<b>PANV1F2LDI17970-</b>						
170 x 75	<b>PANV1F2LDI17975-</b>						
180 x 80	<b>PANV1F2LDI18980-</b>						
180 x 100	<b>PANV1F2LDI18910-</b>						
190 x 90	<b>PANV1F2LDI19990-</b>						

Finitura FRAME	Scelta finitura pannelli per FRAME											
	FRAME		LEGNI				ARGILLA		MDI			
	Bianco Opaco	Nero Opaco	Bianco Opaco*	Bianco rigato	Grain	Burlington	Dolomite	Cenere	Polvere	Tortora	Umbr	Sabbia
	U	H	U	I	M	N	X	R	O	S	1	2
			1.038 €				1.874 €		1.874 €			

Misure	CODICE	Scelta numero pannelli	Scelta finitura pannelli				
			ARGILLA		MDI		
			Cenere	Polvere	Tortora	Umbr	Sabbia
		2 frontali + 2 laterali					
		<b>4</b>	<b>R</b>	<b>O</b>	<b>S</b>	<b>1</b>	<b>2</b>
160 x 70	<b>PANV2F2LDI16970-</b>	2.550 €			2.550 €		
170 x 70	<b>PANV2F2LDI17970-</b>						
170 x 75	<b>PANV2F2LDI17975-</b>						
180 x 80	<b>PANV2F2LDI18980-</b>						
180 x 100	<b>PANV2F2LDI18910-</b>						
190 x 90	<b>PANV2F2LDI19990-</b>						

Finitura FRAME	Scelta finitura pannelli per FRAME											
	FRAME		LEGNI				ARGILLA		MDI			
	Bianco Opaco	Nero Opaco	Bianco Opaco*	Bianco rigato	Grain	Burlington	Dolomite	Cenere	Polvere	Tortora	Umbr	Sabbia
	U	H	U	I	M	N	X	R	O	S	1	2
			1.674 €				2.872 €		2.872 €			

**FRAME SOLO SU PANNELLI FRONTALI**

\* LA FINITURA DI PANNELLO BIANCO OPACO È DISPONIBILE SOLO CON FRAME NERO OPACO

Costruzione del codice **Codice** + **Finitura pannelli** = Codice prodotto finale

Costruzione del codice **Codice** + **Finitura Frame** + **Finitura pannelli** = Codice prodotto finale



DIVINA

VASCA BIANCO MORBIDO CON PANNELLI BURLINGTON + FRAME NERO  
E RUBINETTERIA DIVINA NERA (SOLO SU RICHIESTA)



VASCA BIANCO MORBIDO CON PANNELLO BIANCO OPACO



VASCA BIANCO MORBIDO CON PANNELLO ARGILLA CENERE

## STILE C | FINITURE PANNELLI

### PANNELLI



Bianco lucido

Bianco morbido

### PANNELLI ARGILLA

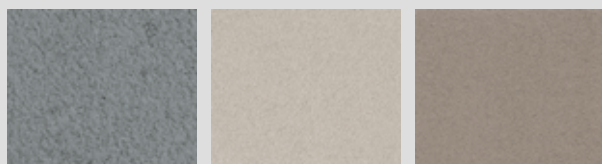

Cenere

Polvere

Tortora

### PANNELLI LEGNO



Bianco rigato

Grain

Burlington

Dolomite

## STILE C | FUNZIONI E DOTAZIONI (disponibili a seconda dell'allestimento)

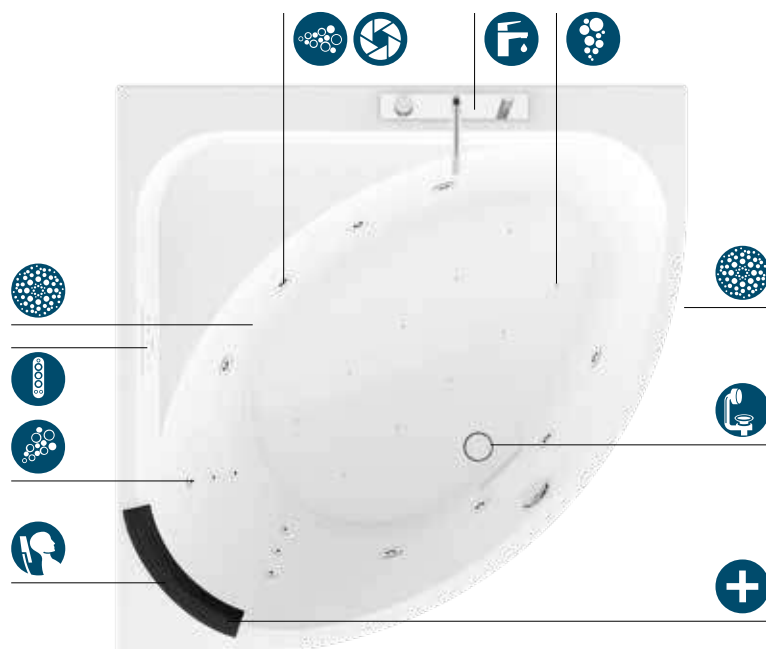

-   **Massaggio Airpool (10 jets)** a getto d'aria con accensione manuale on/off. Per una **efficace stimolazione cellulare**.
-   **Massaggio corpo Whirlpool (6/8 jets)** aria/acqua. Per soddisfare qualsiasi esigenza di benessere. **Cromolight** con 8 variazioni cromatiche per attivare la mente ed emozionare lo spirito.
-  **Massaggio Whirlpool dorsale (6 jets)** aria/acqua.
-  **Natural air**
-  **Pannello di controllo** con funzioni Hydro sequence
-  **Poggiatesta** in materiale antibatterico.
-  **Rubinetteria bordo vasca**
-  **Colonna di scarico**
-  **Disinfezione**

Designed by Marco Pellici



VASCA BIANCO LUCIDO CON PANNELLO DOLOMITE



Pannello di comando capacitivo



Piano di appoggio



Nuova manopola di scarico  
ultra-flat



Nuove bocchette idromassaggio

STILE

# STILE C

# STILE C

## VASCA ANGOLARE SIMMETRICA SEMICIRCOLARE

Misure			Capacità	Codice	Scelta rubinetteria + finitura vasca						Scelta struttura / Pannello	
Cm	H	Lt.			Colonna di scarico senza rubinetteria		Colonna di scarico con erogazione da troppo pieno		Colonna di scarico + rubinetteria bordo vasca		Senza pannelli	Con pannelli
					Bianco lucido	Bianco morbido	Bianco lucido	Bianco morbido	Bianco lucido	Bianco morbido		
<b>STANDARD DA INCASSO</b>												
					<b>0-A</b>	<b>0-U</b>	<b>1-A</b>	<b>1-U</b>	<b>2-A</b>	<b>2-U</b>	<b>0K</b>	
135 X 135	63	310	<b>STI1135135</b>	1.090 €	1.188 €	1.160 €	1.258 €	1.715 €	1.813 €			
<b>STANDARD CON TELAIO</b>												
					<b>0-A</b>	<b>0-U</b>	<b>1-A</b>	<b>1-U</b>	<b>2-A</b>	<b>2-U</b>	<b>0K</b>	
135 X 135	63	310	<b>STI2135135</b>	1.454 €	1.552 €	1.524 €	1.622 €	2.079 €	2.177 €			* Vedi tabella <b>SCELTA FINITURA PANNELLO</b>
<b>HYDRO AIR</b>												
					<b>0-A</b>	<b>0-U</b>	<b>1-A</b>	<b>1-U</b>	<b>2-A</b>	<b>2-U</b>	<b>0K</b>	
135 X 135	63	310	<b>STIY1351350</b>	2.536 €	2.634 €	2.606 €	2.704 €	3.161 €	3.259 €			* Vedi tabella <b>SCELTA FINITURA PANNELLO</b>
<b>WHIRLPOOL</b>												
					<b>0-A</b>	<b>0-U</b>	<b>1-A</b>	<b>1-U</b>	<b>2-A</b>	<b>2-U</b>	<b>0K</b>	
135 X 135	63	310	<b>STI51351350</b>	2.749 €	2.847 €	2.819 €	2.917 €	3.374 €	3.472 €			* Vedi tabella <b>SCELTA FINITURA PANNELLO</b>
<b>WHIRLPOOL+DISINFEZIONE+LIGHT</b>												
					<b>0-A</b>	<b>0-U</b>	<b>1-A</b>	<b>1-U</b>	<b>2-A</b>	<b>2-U</b>	<b>0K</b>	
135 X 135	63	310	<b>STI31351350</b>	3.553 €	3.651 €	3.623 €	3.721 €	4.178 €	4.276 €			* Vedi tabella <b>SCELTA FINITURA PANNELLO</b>
<b>HYDRO PLUS</b>												
					<b>0-A</b>	<b>0-U</b>	<b>1-A</b>	<b>1-U</b>	<b>2-A</b>	<b>2-U</b>	<b>0K</b>	
135 X 135	63	310	<b>STI41351350</b>	4.514 €	4.612 €	4.584 €	4.682 €	5.139 €	5.237 €			* Vedi tabella <b>SCELTA FINITURA PANNELLO</b>
<b>NATURAL AIR + HYDRO</b>												
					<b>0-A</b>	<b>0-U</b>	<b>1-A</b>	<b>1-U</b>	<b>2-A</b>	<b>2-U</b>	<b>0K</b>	
135 X 135	63	310	<b>STIP1351350</b>	5.227 €	5.325 €	5.297 €	5.395 €	5.852 €	5.950 €			* Vedi tabella <b>SCELTA FINITURA PANNELLO</b>



VASCA BIANCO LUCIDO CON PANNELLO ARGILLA POLVERE

	Scelta finitura pannelli /prezzo								
	ACRILICO		LEGNI				ARGILLA		
	1 pannello finitura vasca bianco lucido	1 pannello finitura vasca bianco morbido	Bianco rigato	Grain	Burlington	Dolomite	Cenere	Polvere	Tortora
	<b>1A</b>	<b>1U</b>	<b>1I</b>	<b>1M</b>	<b>1N</b>	<b>1X</b>	<b>1R</b>	<b>10</b>	<b>1S</b>
	+ 452 €		+ 799 €				+ 1.095 €		

Costruzione codice vasca senza pannelli **Codice** + **Scelta scarico/erogazione + Finitura vasca** + **Scelta struttura senza pannelli** = Codice prodotto finale

Costruzione codice vasca con pannelli **Codice** + **Scelta scarico/erogazione + Finitura vasca** + **Scelta struttura con pannelli (acrilico o legni)** = Codice prodotto finale

**COLORI SPECIALI SU RICHIESTA PER PANNELLI ARGILLA**

				<b>PANNELLI</b>	<b>Prezzo</b>
Cipria cod. 3	Tegola cod. 4	Alga cod. 5	Senape cod. 6	1 pannello	+125 €

**RUBINETTERIA IN COLORE NERO SU RICHIESTA: + € 125**

STILE



VASCA BIANCO MORBIDO CON PANNELLI IN DOLOMITE



VASCA BIANCO MORBIDO CON PANNELLI IN ARGILLA POLVERE E FRAME NERO OPACO

## STILE | FINITURE PANNELLI

### ACRILICO



Bianco  
lucido

Bianco  
morbido

### LEGNO



Bianco  
rigato

Grain

Burlington

Dolomite

### ARGILLA

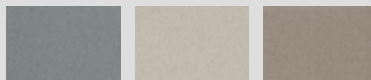

Cenere

Polvere

Tortora

### MDI



Umbra

Sabbia

### FRAME ALLUMINIO NERO OPACO



Bianco  
morbido

### LEGNO



Bianco  
rigato

Grain

Burlington

Dolomite

### ARGILLA

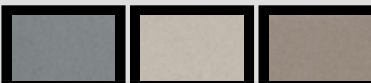

Cenere

Polvere

Tortora

### MDI



Umbra

Sabbia

### FRAME ALLUMINIO BIANCO OPACO

### LEGNO



Bianco  
rigato

Grain

Burlington

Dolomite

### ARGILLA

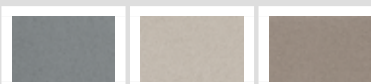

Cenere

Polvere

Tortora

### MDI

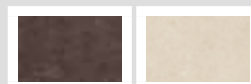

Umbra

Sabbia

## STILE | FUNZIONI E DOTAZIONI (disponibili a seconda dell'allestimento)

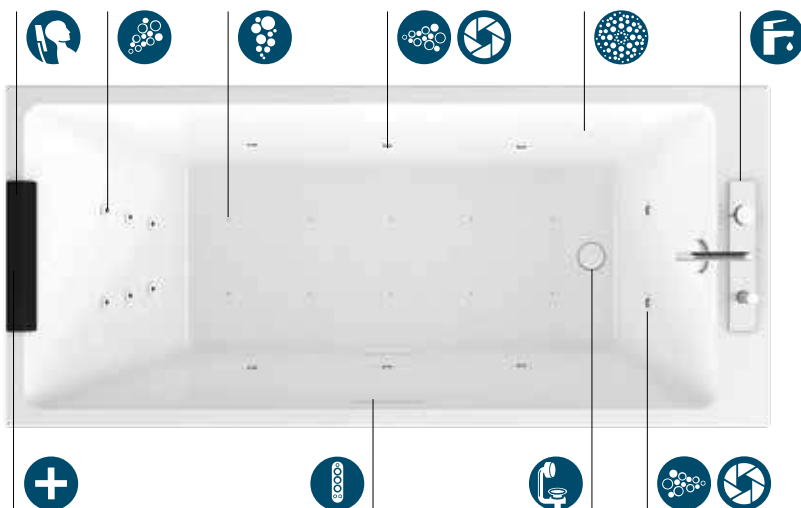

**Massaggio Airpool (10 jets)** a getto d'aria con accensione manuale on/off. Per una **efficace stimolazione cellulare**.



**Massaggio corpo Whirlpool (6/8 jets)** aria/acqua. Per soddisfare qualsiasi esigenza di benessere. **Cromolight** con 8 variazioni cromatiche per attivare la mente ed emozionare lo spirito.



**Massaggio Whirlpool dorsale (6 jets)** aria/acqua.



**Natural air**



**Pannello di controllo** capacitivo



**Poggiatesta** in materiale antibatterico.



**Rubinetteria bordo vasca**



**Colonna di scarico**



**Disinfezione**

Designed by Marco Pellici





VASCA BIANCO MORBIDO CON PANNELLI IN MDI SABBIA E FRAME NERO OPACO



Pannello di comando capacitivo



Piano di appoggio



Nuova manopola di scarico ultra-flat



Nuove bocchette idromassaggio

STILE

# STILE

# STILE

## VASCA RETTANGOLARE

Misure			Capacità	Codice	Scelta rubinetteria + finitura vasca						Scelta struttura/pannelli	
Cm	H	Lt.			Colonna di scarico senza rubinetteria		Colonna di scarico con erogazione da troppo pieno		Colonna di scarico + rubinetteria bordo vasca		Solo struttura	Con pannelli
					Bianco lucido	Bianco morbido	Bianco lucido	Bianco morbido	Bianco lucido	Bianco morbido		

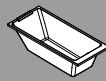
STANDARD DA INCASSO												
				0-A	0-U	1-A	1-U	2-A	2-U	0K		
170 x 70	63	250	<b>STI117970</b>									
170 x 75	63	280	<b>STI117975</b>	814 €	912 €	884 €	982 €	1.439 €	1.537 €			
180 x 80	63	330	<b>STI118980</b>									
180 x 110	63	500	<b>STI118911</b>									
190 x 90	63	410	<b>STI119990</b>	1.090 €	1.188 €	1.160 €	1.258 €	1.715 €	1.813 €			

STANDARD CON TELAIO												
				0-A	0-U	1-A	1-U	2-A	2-U	0K		
170 x 70	63	250	<b>STI217970</b>								* Vedi tabella <b>SCELTA FINITURA PANNELLO</b>	
170 x 75	63	280	<b>STI217975</b>	1.039 €	1.137 €	1.109 €	1.207 €	1.664 €	1.762 €			
180 x 80	63	330	<b>STI218980</b>									
180 x 110	63	500	<b>STI218911</b>									
190 x 90	63	410	<b>STI219990</b>	1.302 €	1.399 €	1.372 €	1.470 €	1.927 €	2.025 €			

HYDRO AIR												
				0-A	0-U	1-A	1-U	2-A	2-U	0K		
170 x 70	63	250	<b>STIY179700</b>								* Vedi tabella <b>SCELTA FINITURA PANNELLO</b>	
170 x 75	63	280	<b>STIY179750</b>	2.222 €	2.320 €	2.292 €	2.390 €	2.847 €	2.945 €			
180 x 80	63	330	<b>STIY189800</b>									
180 x 110	63	500	<b>STIY189110</b>									
190 x 90	63	410	<b>STIY199900</b>	2.467 €	2.575 €	2.537 €	2.635 €	3.092 €	3.190 €			

WHIRLPOOL												
				0-A	0-U	1-A	1-U	2-A	2-U	0K		
170 x 70	63	250	<b>STI5179700</b>								* Vedi tabella <b>SCELTA FINITURA PANNELLO</b>	
170 x 75	63	280	<b>STI5179750</b>	2.434 €	2.532 €	2.504 €	2.602 €	3.059 €	3.157 €			
180 x 80	63	330	<b>STI5189800</b>									
180 x 110	63	500	<b>STI5189110</b>									
190 x 90	63	410	<b>STI5199900</b>	2.678 €	2.786 €	2.748 €	2.846 €	3.303 €	3.401 €			

WHIRLPOOL+DISINFEZIONE+LIGHT												
				0-A	0-U	1-A	1-U	2-A	2-U	0K		
170 x 70	63	250	<b>STI3179700</b>								* Vedi tabella <b>SCELTA FINITURA PANNELLO</b>	
170 x 75	63	280	<b>STI3179750</b>	3.238 €	3.336 €	3.308 €	3.406 €	3.863 €	3.961 €			
180 x 80	63	330	<b>STI3189800</b>									
180 x 110	63	500	<b>STI3189110</b>									
190 x 90	63	410	<b>STI3199900</b>	3.563 €	3.669 €	3.633 €	3.731 €	4.188 €	4.286 €			

Misure	Capacità	Codice	Scelta rubinetteria + finitura vasca						Scelta struttura/pannelli	
			Colonna di scarico senza rubinetteria		Colonna di scarico con erogazione da troppo pieno		Colonna di scarico + rubinetteria bordo vasca		Solo struttura	Con pannelli
			Bianco lucido	Bianco morbido	Bianco lucido	Bianco morbido	Bianco lucido	Bianco morbido		

### HYDRO PLUS

				0-A	0-U	1-A	1-U	2-A	2-U	0K	* Vedi tabella <b>SCELTA FINITURA PANNELLO</b>
170 x 70	63	250	<b>STI4179700</b>								
170 x 75	63	280	<b>STI4179750</b>	4.198 €	4.296 €	4.268 €	4.366 €	4.823 €	4.921 €		
180 x 80	63	330	<b>STI4189800</b>								
180 x 110	63	500	<b>STI4189110</b>	4.450 €	4.554 €	4.520 €	4.618 €	5.075 €	5.173 €		
190 x 90	63	410	<b>STI4199900</b>								

### NATURAL AIR + WHIRLPOOL

				0-A	0-U	1-A	1-U	2-A	2-U	0K	* Vedi tabella <b>SCELTA FINITURA PANNELLO</b>
170 x 70	63	250	<b>STIP179700</b>								
170 x 75	63	280	<b>STIP179750</b>	4.912 €	5.010 €	4.982 €	5.080 €	5.537 €	5.635 €		
180 x 80	63	330	<b>STIP189800</b>								
180 x 110	63	500	<b>STIP189110</b>	5.158 €	5.260 €	5.228 €	5.326 €	5.783 €	5.881 €		
190 x 90	63	410	<b>STIP199900</b>								

Scelta numero pannelli				Scelta finitura pannelli / prezzo					
				ACRILICO		LEGNI			
1 frontale	1 frontale + 1 laterale	1 frontale + 2 laterali	2 frontali + 2 laterali	Bianco Lucido	Bianco morbido	Bianco rigato	Grain	Burlington	Dolomite
<b>1</b>	<b>2</b>	<b>3</b>	<b>4</b>	<b>A</b>	<b>U</b>	<b>I</b>	<b>M</b>	<b>N</b>	<b>X</b>
	-	-	-	+ 310 €	+ 329 €	+ 355 €			
-		-	-	+ 452 €	+ 478 €	+ 515 €			
-	-		-	+ 632 €	+ 664 €	+ 715 €			
-	-	-		+ 902 €	+ 954 €	+ 1.030 €			

Costruzione codice vasca senza pannelli **Codice** + **Scelta scarico/erogazione + Finitura vasca** + **Scelta struttura senza pannelli** = Codice prodotto finale

Costruzione codice vasca con pannelli **Codice** + **Scelta scarico/erogazione + Finitura vasca** + **Scelta struttura con pannelli (acrilico o legni)** = Codice prodotto finale



**RUBINETTERIA IN COLORE NERO SU RICHIESTA: + € 125**

STILE

PER LA VERSIONE CON I PANNELLI IN FINITURA ARGILLA/FRAME ORDINARE: 1 CODICE VASCA SOLO STRUTTURA + 1 CODICE PANNELLI ARGILLA/FRAME (QUI SOTTO)

Misure	CODICE Scelta numero pannelli 	Scelta finitura pannelli					Finitura FRAME	Scelta finitura pannelli per FRAME										
		ARGILLA			MDI			FRAME	LEGNI					ARGILLA		MDI		
		Cenere	Polvere	Tortora	Umbra	Sabbia	Bianco Opaco	Nero Opaco	Bianco Opaco*	Bianco rigato	Grain	Burlington	Dolomite	Cenere	Polvere	Tortora	Umbra	Sabbia
		<b>R</b>	<b>O</b>	<b>S</b>	<b>1</b>	<b>2</b>	<b>U</b>	<b>H</b>	<b>U</b>	<b>I</b>	<b>M</b>	<b>N</b>	<b>X</b>	<b>R</b>	<b>O</b>	<b>S</b>	<b>1</b>	<b>2</b>
170 x 70; 170 x 75	<b>PANV1FDI179-</b>						677 €					1.038 €		1.038 €				
180 x 80; 180 x 110	<b>PANV1FDI189-</b>	877 €																
190 x 90	<b>PANV1FDI199-</b>																	
170 x 70	<b>PANV1F1LDI17970-</b>						838 €					1.437 €		1.437 €				
170 x 75	<b>PANV1F1LDI17975-</b>	1.275 €																
180 x 80	<b>PANV1F1LDI18980-</b>																	
180 x 110	<b>PANV1F1LDI18911-</b>																	
190 x 90	<b>PANV1F1LDI19990-</b>																	
170 x 70	<b>PANV1F2LDI17970-</b>						1.038 €					1.874 €		1.874 €				
170 x 75	<b>PANV1F2LDI17975-</b>	1.713 €																
180 x 80	<b>PANV1F2LDI18980-</b>																	
180 x 110	<b>PANV1F2LDI18911-</b>																	
190 x 90	<b>PANV1F2LDI19990-</b>																	
170 x 70	<b>PANV2F2LDI17970-</b>						1.674 €					2.872 €		2.872 €				
170 x 75	<b>PANV2F2LDI17975-</b>	2.550 €																
180 x 80	<b>PANV2F2LDI18980-</b>																	
180 x 110	<b>PANV2F2LDI18911-</b>																	
190 x 90	<b>PANV2F2LDI19990-</b>																	

**FRAME SOLO SU PANNELLI FRONTALI**

\* LA FINITURA DI PANNELLO BIANCO OPACO È DISPONIBILE SOLO CON FRAME NERO OPACO

Costruzione del codice **Codice** + **Finitura pannelli** = Codice prodotto finale

Costruzione del codice **Codice** + **Finitura Frame** + **Finitura pannelli** = Codice prodotto finale

**COLORI SPECIALI SU RICHIESTA PER PANNELLI ARGILLA E FRAME ARGILLA**



Cipria cod. 3



Tegola cod. 4



Alga cod. 5



Senape cod. 6

PANNELLI	Prezzo
1-2 pannelli	+125 €
3-4 pannelli	+250 €



MISURA 170X75



MISURA 180X110

STILE



VASCA BIANCO MORBIDO CON PANNELLI BIANCO MORBIDO



VASCA BIANCO MORBIDO CON PANNELLI BIANCO MORBIDO E BORDO VASCA DOLOMITE

## SENSE DUAL | FINITURE PANNELLI E BORDO VASCA

### PANNELLI



Bianco lucido

Bianco morbido

### PANNELLI LEGNO

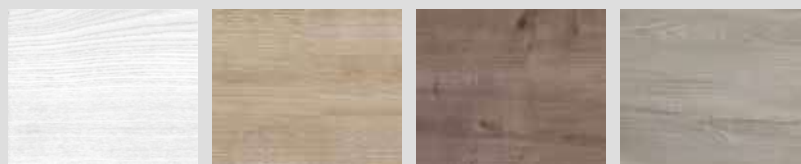

Bianco rigato

Grain

Burlington

Dolomite

### BORDO VASCA LAMINATO



Bianco lucido

Bianco morbido

### BORDO VASCA FINITURE LEGNO



Bianco rigato

Grain

Burlington

Dolomite

## SENSE DUAL | FUNZIONI E DOTAZIONI (disponibili a seconda dell'allestimento)



**Massaggio Airpool (14 jets)** a getto d'aria con accensione manuale on/off. Per una **efficace stimolazione cellulare**.



**Massaggio corpo Whirlpool (10 jets)** aria/acqua. Per soddisfare qualsiasi esigenza di benessere.



**Accensione soft-touch**



**Poggiatesta** in pelle bianca



**Rubinetteria bordo vasca** con tubo di scarico salvagoccia



**Cromolight** 4 stagioni, programmazione manuale o con sequenze prestabilite. Una sinfonia di luci e colori per un crescendo di **emozioni sensoriali**



**Riscaldatore**



**Disinfezione**



Griglia del troppo pieno

Griglia di aspirazione



**Radio RDS stereo** con 4 diffusori acustici e **Bluetooth**



VASCA BIANCO MORBIDO CON PANNELLI GRAIN E BORDO VASCA BIANCO MORBIDO



Poggiatesta in vera pelle bianca



Sistema audio con collegamento bluetooth



Riscaldatore per il mantenimento della temperatura dell'acqua



Cromolight integrata per stimolare corpo ed emozioni

SENSE



# SENSE DUAL

# SENSE DUAL

## VASCA RETTANGOLARE DOPPIA POSTAZIONE

Misure	Capacità	Codice	Finitura vasca	Finitura bordo vasca						
				Laminato			Finitura legno			
Cm	H	Lt.	Bianco lucido	Bianco morbido	Bianco lucido	Bianco morbido	Bianco rigato	Grain	Burlington	Dolomite

### ESSENTIAL

					-A0	-U0	A	U	I	M	N	X
	193X140	64	430	<b>SE2190142</b>	6.764 €	6.863 €						

### HYDRO PLUS

					-A0	-U0	A	U	I	M	N	X
	193X140	64	430	<b>SE719014T7</b>	10.837 €	10.935 €						

### PANNELLO FRONTALE 193 CM

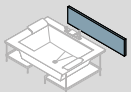
			A	U	I	M	N	X
	193 x 140	<b>PANVFSE194-</b>	592 €	592 €	592 €	592 €	592 €	592 €

### PANNELLO FRONTALE 193 CM; PANNELLO LATERALE 140 CM

			A	U	I	M	N	X
	193 x 140	<b>PANVFLSE194-</b>	985 €	985 €	985 €	985 €	985 €	985 €

### PANNELLO FRONTALE 193 CM; 2 PANNELLI LATERALI 140 CM

			A	U	I	M	N	X
	193 x 140	<b>PANVF2LSE194-</b>	1.313 €	1.313 €	1.313 €	1.313 €	1.313 €	1.313 €

### 2 PANNELLI FRONTALI 193 CM; 2 PANNELLI LATERALI 140 CM

			A	U	I	M	N	X
	193 x 140	<b>PANVFLSE194C-</b>	1.969 €	1.969 €	1.969 €	1.969 €	1.969 €	1.969 €

PER TUTTI GLI OPTIONAL VEDI PAG. 553-554





SENSE



VASCA BIANCO MORBIDO CON PANNELLI BIANCO RIGATO



VASCA BIANCO MORBIDO CON PANNELLI BURLINGTON

## SENSE 2.0 | FINITURE PANNELLI

### ACRILICO



Bianco lucido Bianco morbido

### LEGNO



Bianco rigato Grain Burlington Dolomite

### ARGILLA

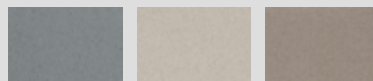

Cenere Polvere Tortora

### MDI



Umbra Sabbia

### FRAME ALLUMINIO NERO OPACO



Bianco morbido

### LEGNO

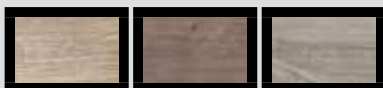

Grain Burlington Dolomite

### ARGILLA

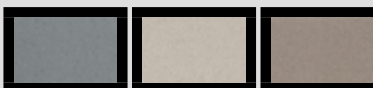

Cenere Polvere Tortora

### MDI



Umbra Sabbia

### FRAME ALLUMINIO BIANCO OPACO

### LEGNO

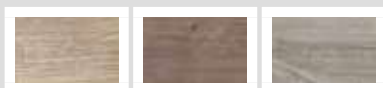

Grain Burlington Dolomite

### ARGILLA

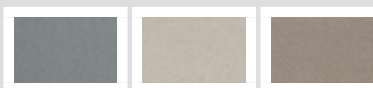

Cenere Polvere Tortora

### MDI

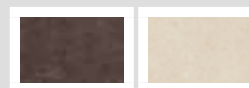

Umbra Sabbia

## SENSE 3-4 2.0 | FUNZIONI E DOTAZIONI (disponibili a seconda dell'allestimento)

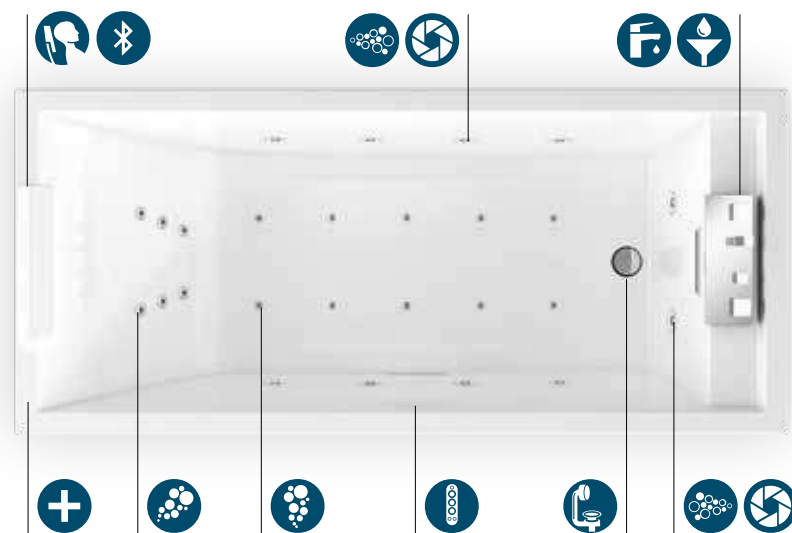

**Massaggio Airpool (10 jets)** a getto d'aria con accensione manuale on/off. Per una **efficace stimolazione cellulare**.



**Massaggio corpo Whirlpool (8/10 jets)** aria/acqua. Per soddisfare qualsiasi esigenza di benessere. **Cromolight** con 8 variazioni cromatiche per attivare la mente ed emozionare lo spirito.



**Massaggio Whirlpool dorsale (6 jets)** aria/acqua.



**Pannello di controllo** con funzioni Hydro Sequence



**Poggiatesta** in materiale antibatterico



**Rubinetteria bordo vasca** con tubo di scarico salvagoccia



**Disinfezione**



**Bluetooth**



**Colonna di scarico**



VASCA BIANCO MORBIDO CON PANNELLI ARGILLA POLVERE



Rubinetteria bordo vasca con tubo di scarico salvagoccia



Bocchetta idromassaggio cromata



Pannello di comando capacitivo



Poggiatesta in materiale atossico e idrorepellente

SENSE

# SENSE 2.0

# SENSE 3 2.0

VASCA RETTANGOLARE



SENSE 3 2.0

Misure			Capacità	Codice	Scelta rubinetteria + finitura vasca				Scelta struttura/pannelli	
Cm	H	Lt.			 Colonna di scarico senza rubinetteria Bianco lucido    Bianco morbido		 Colonna di scarico + rubinetteria bordo vasca Bianco lucido    Bianco morbido		 Solo struttura	Con pannelli

## STANDARD DA INCASSO

				Ø-A	Ø-U	2-A	2-U	ØK	
170 X 70	63	205	<b>S23117970</b>	1.139 €	1.237 €	2.228 €	2.325 €		
170 X 75	63	225	<b>S23117975</b>						
180 X 80	63	250	<b>S23118980</b>						
190 X 80	63	265	<b>S23119980</b>						

## STANDARD CON TELAIO

				Ø-A	Ø-U	2-A	2-U	ØK	* Vedi tabella <b>SCelta                      FINITURA                      PANNELLO</b>
170 X 70	63	205	<b>S23217970</b>	1.363 €	1.460 €	2.452 €	2.549 €		
170 X 75	63	225	<b>S23217975</b>						
180 X 80	63	250	<b>S23218980</b>						
190 X 80	63	265	<b>S23219980</b>						

## HYDRO AIR

				Ø-A	Ø-U	2-A	2-U	ØK	* Vedi tabella <b>SCelta                      FINITURA                      PANNELLO</b>
170 X 70	63	205	<b>S23Y179700</b>	2.375 €	2.473 €	3.464 €	3.562 €		
170 X 75	63	225	<b>S23Y179750</b>						
180 X 80	63	250	<b>S23Y189800</b>						
190 X 80	63	265	<b>S23Y199800</b>						

## WHIRLPOOL+DISINFEZIONE

				Ø-A	Ø-U	2-A	2-U	ØK	* Vedi tabella <b>SCelta                      FINITURA                      PANNELLO</b>
170 X 70	63	205	<b>S235179700</b>	3.093 €	3.190 €	4.182 €	4.279 €		
170 X 75	63	225	<b>S235179750</b>						
180 X 80	63	250	<b>S235189800</b>						
190 X 80	63	265	<b>S235199800</b>						

## WHIRLPOOL+DISINFEZIONE+LIGHT

				Ø-A	Ø-U	2-A	2-U	ØK	* Vedi tabella <b>SCelta                      FINITURA                      PANNELLO</b>
170 X 70	63	205	<b>S233179700</b>	3.750 €	3.848 €	4.839 €	4.937 €		
170 X 75	63	225	<b>S233179750</b>						
180 X 80	63	250	<b>S233189800</b>						
190 X 80	63	265	<b>S233199800</b>						

## HYDRO PLUS

				Ø-A	Ø-U	2-A	2-U	ØK	* Vedi tabella <b>SCelta                      FINITURA                      PANNELLO</b>
170 X 70	63	205	<b>S234179700</b>	5.045 €	5.143 €	6.134 €	6.232 €		
170 X 75	63	225	<b>S234179750</b>						
180 X 80	63	250	<b>S234189800</b>						
190 X 80	63	265	<b>S234199800</b>						

## WHIRLPOOL+NATURAL AIR

				Ø-A	Ø-U	2-A	2-U	ØK	* Vedi tabella <b>SCelta                      FINITURA                      PANNELLO</b>
170 X 70	63	205	<b>S23P179700</b>	5.425 €	5.523 €	6.514 €	6.612 €		
170 X 75	63	225	<b>S23P179750</b>						
180 X 80	63	250	<b>S23P189800</b>						
190 X 80	63	265	<b>S23P199800</b>						



SENSE

Scelta numero pannelli				Scelta finitura pannelli / prezzo					
				ACRILICO		LEGNI			
1 frontale	1 frontale + 1 laterale	1 frontale + 2 laterali	2 frontali + 2 laterali	Bianco Lucido	Bianco morbido	Bianco rigato	Grain	Burlington	Dolomite
<b>1</b>	<b>2</b>	<b>3</b>	<b>4</b>	<b>A</b>	<b>U</b>	<b>I</b>	<b>M</b>	<b>N</b>	<b>X</b>
	-	-	-	+ 310 €	+ 329 €	+ 355 €			
-		-	-	+ 452 €	+ 478 €	+ 515 €			
-	-		-	+ 632 €	+ 664 €	+ 715 €			
-	-	-		+ 902 €	+ 954 €	+ 1.030 €			

Costruzione codice vasca senza pannelli **Codice** + **Scelta scarico/erogazione + Finitura vasca** + **Scelta struttura senza pannelli** = Codice prodotto finale

Costruzione codice vasca con pannelli **Codice** + **Scelta scarico/erogazione + Finitura vasca** + **Scelta struttura con pannelli (acrilico o legni)** = Codice prodotto finale

# SENSE 4 2.0

VASCA RETTANGOLARE



SENSE 4 2.0

Misure			Capacità	Codice	Scelta rubinetteria + finitura vasca				Scelta struttura/pannelli	
Cm	H	Lt.			 Colonna di scarico senza rubinetteria Bianco lucido    Bianco morbido		 Colonna di scarico + rubinetteria bordo vasca Bianco lucido    Bianco morbido		 Solo struttura	Con pannelli

## STANDARD DA INCASSO

				0-A	0-U	2-A	2-U	0K	
170 X 70	63	215	<b>S24117970</b>	1.005 €	1.103 €	2.094 €	2.192 €		
170 X 75	63	235	<b>S24117975</b>						
180 X 80	63	265	<b>S24118980</b>						
190 X 80	63	280	<b>S24119980</b>						

## STANDARD CON TELAIO

				0-A	0-U	2-A	2-U	0K	* Vedi tabella <b>SCelta                      FINITURA                      PANNELLO</b>
170 X 70	63	215	<b>S24217970</b>	1.229 €	1.327 €	2.318 €	2.415 €		
170 X 75	63	235	<b>S24217975</b>						
180 X 80	63	265	<b>S24218980</b>						
190 X 80	63	280	<b>S24219980</b>						

## HYDRO AIR

				0-A	0-U	2-A	2-U	0K	* Vedi tabella <b>SCelta                      FINITURA                      PANNELLO</b>
170 X 70	63	215	<b>S24Y179700</b>	2.240 €	2.338 €	3.329 €	3.427 €		
170 X 75	63	235	<b>S24Y179750</b>						
180 X 80	63	265	<b>S24Y189800</b>						
190 X 80	63	280	<b>S24Y199800</b>						

## WHIRLPOOL+DISINFEZIONE

				0-A	0-U	2-A	2-U	0K	* Vedi tabella <b>SCelta                      FINITURA                      PANNELLO</b>
170 X 70	63	215	<b>S245179700</b>	2.959 €	3.057 €	4.048 €	4.145 €		
170 X 75	63	235	<b>S245179750</b>						
180 X 80	63	265	<b>S245189800</b>						
190 X 80	63	280	<b>S245199800</b>						

## WHIRLPOOL+DISINFEZIONE+LIGHT

				0-A	0-U	2-A	2-U	0K	* Vedi tabella <b>SCelta                      FINITURA                      PANNELLO</b>
170 X 70	63	215	<b>S243179700</b>	3.617 €	3.714 €	4.705 €	4.803 €		
170 X 75	63	235	<b>S243179750</b>						
180 X 80	63	265	<b>S243189800</b>						
190 X 80	63	280	<b>S243199800</b>						

## HYDRO PLUS

				0-A	0-U	2-A	2-U	0K	* Vedi tabella <b>SCelta                      FINITURA                      PANNELLO</b>
170 X 70	63	215	<b>S244179700</b>	4.912 €	5.009 €	6.000 €	6.098 €		
170 X 75	63	235	<b>S244179750</b>						
180 X 80	63	265	<b>S244189800</b>						
190 X 80	63	280	<b>S244199800</b>						

## WHIRLPOOL+NATURAL AIR

				0-A	0-U	2-A	2-U	0K	* Vedi tabella <b>SCelta                      FINITURA                      PANNELLO</b>
170 X 70	63	215	<b>S24P179700</b>	5.292 €	5.389 €	6.380 €	6.478 €		
170 X 75	63	235	<b>S24P179750</b>						
180 X 80	63	265	<b>S24P189800</b>						
190 X 80	63	280	<b>S24P199800</b>						







SENSE

Scelta numero pannelli				Scelta finitura pannelli / prezzo					
				ACRILICO		LEGNI			
1 frontale	1 frontale + 1 laterale	1 frontale + 2 laterali	2 frontali + 2 laterali	Bianco Lucido	Bianco morbido	Bianco rigato	Grain	Burlington	Dolomite
<b>1</b>	<b>2</b>	<b>3</b>	<b>4</b>	<b>A</b>	<b>U</b>	<b>I</b>	<b>M</b>	<b>N</b>	<b>X</b>
	-	-	-	+ 310 €	+ 329 €	+ 355 €			
-		-	-	+ 452 €	+ 478 €	+ 515 €			
-	-		-	+ 632 €	+ 664 €	+ 715 €			
-	-	-		+ 902 €	+ 954 €	+ 1.030 €			

Costruzione codice vasca senza pannelli **Codice** + **Scelta scarico/erogazione + Finitura vasca** + **Scelta struttura senza pannelli** = Codice prodotto finale

Costruzione codice vasca con pannelli **Codice** + **Scelta scarico/erogazione + Finitura vasca** + **Scelta struttura con pannelli (acrilico o legni)** = Codice prodotto finale

**PER LA VERSIONE CON I PANNELLI IN FINITURA ARGILLA/FRAME ORDINARE: 1 CODICE VASCA SOLO STRUTTURA + 1 CODICE PANNELLI ARGILLA/FRAME (QUI SOTTO)**

Misure	CODICE Scelta numero pannelli	Scelta finitura pannelli					Finitura FRAME	Scelta finitura pannelli per FRAME									
		ARGILLA		MDI			FRAME		LEGNI				ARGILLA			MDI	
		Cenere	Polvere	Tortora	Umbra	Sabbia	Bianco Opaco	Nero Opaco	Bianco Opaco*	Grain	Burlington	Dolomite	Cenere	Polvere	Tortora	Umbra	Sabbia
		<b>R</b>	<b>O</b>	<b>S</b>	<b>1</b>	<b>2</b>	<b>U</b>	<b>H</b>	<b>U</b>	<b>M</b>	<b>N</b>	<b>X</b>	<b>R</b>	<b>O</b>	<b>S</b>	<b>1</b>	<b>2</b>
170 x 70; 170 x 75	<b>PANV1FDI179-</b>	877 €					677 €					1.038 €			1.038 €		
180 x 80	<b>PANV1FDI189-</b>	877 €					677 €					1.038 €			1.038 €		
190 x 80	<b>PANV1FDI199-</b>	877 €					677 €					1.038 €			1.038 €		
		Cenere	Polvere	Tortora	Umbra	Sabbia	Bianco Opaco	Nero Opaco	Bianco Opaco*	Grain	Burlington	Dolomite	Cenere	Polvere	Tortora	Umbra	Sabbia
		<b>R</b>	<b>O</b>	<b>S</b>	<b>1</b>	<b>2</b>	<b>U</b>	<b>H</b>	<b>U</b>	<b>M</b>	<b>N</b>	<b>X</b>	<b>R</b>	<b>O</b>	<b>S</b>	<b>1</b>	<b>2</b>
170 x 70	<b>PANV1F1LDI17970-</b>	1.275 €					838 €					1.437 €			1.437 €		
170 x 75	<b>PANV1F1LDI17975-</b>	1.275 €					838 €					1.437 €			1.437 €		
180 x 80	<b>PANV1F1LDI18980-</b>	1.275 €					838 €					1.437 €			1.437 €		
190 x 80	<b>PANV1F1LDI19980-</b>	1.275 €					838 €					1.437 €			1.437 €		
		Cenere	Polvere	Tortora	Umbra	Sabbia	Bianco Opaco	Nero Opaco	Bianco Opaco*	Grain	Burlington	Dolomite	Cenere	Polvere	Tortora	Umbra	Sabbia
		<b>R</b>	<b>O</b>	<b>S</b>	<b>1</b>	<b>2</b>	<b>U</b>	<b>H</b>	<b>U</b>	<b>M</b>	<b>N</b>	<b>X</b>	<b>R</b>	<b>O</b>	<b>S</b>	<b>1</b>	<b>2</b>
170 x 70	<b>PANV1F2LDI17970-</b>	1.713 €					1.038 €					1.874 €			1.874 €		
170 x 75	<b>PANV1F2LDI17975-</b>	1.713 €					1.038 €					1.874 €			1.874 €		
180 x 80	<b>PANV1F2LDI18980-</b>	1.713 €					1.038 €					1.874 €			1.874 €		
190 x 80	<b>PANV1F2LDI19980-</b>	1.713 €					1.038 €					1.874 €			1.874 €		
		Cenere	Polvere	Tortora	Umbra	Sabbia	Bianco Opaco	Nero Opaco	Bianco Opaco*	Grain	Burlington	Dolomite	Cenere	Polvere	Tortora	Umbra	Sabbia
		<b>R</b>	<b>O</b>	<b>S</b>	<b>1</b>	<b>2</b>	<b>U</b>	<b>H</b>	<b>U</b>	<b>M</b>	<b>N</b>	<b>X</b>	<b>R</b>	<b>O</b>	<b>S</b>	<b>1</b>	<b>2</b>
170 x 70	<b>PANV2F2LDI17970-</b>	2.550 €					1.674 €					2.872 €			2.872 €		
170 x 75	<b>PANV2F2LDI17975-</b>	2.550 €					1.674 €					2.872 €			2.872 €		
180 x 80	<b>PANV2F2LDI18980-</b>	2.550 €					1.674 €					2.872 €			2.872 €		
190 x 80	<b>PANV2F2LDI19980-</b>	2.550 €					1.674 €					2.872 €			2.872 €		

**FRAME SOLO SU PANNELLI FRONTALI**

\* LA FINITURA DI PANNELLO BIANCO OPACO È DISPONIBILE SOLO CON FRAME NERO OPACO

Costruzione del codice **Codice** + **Finitura pannelli** = Codice prodotto finale

Costruzione del codice **Codice** + **Finitura Frame** + **Finitura pannelli** = Codice prodotto finale

**COLORI SPECIALI SU RICHIESTA PER PANNELLI ARGILLA E FRAME ARGILLA**



Cipria cod. 3



Tegola cod. 4



Alga cod. 5



Senape cod. 6

PANNELLI	Prezzo
1-2 pannelli	+125 €
3-4 pannelli	+250 €





SENSE



VASCA CON PANNELLI BIANCO LUCIDO



VASCA CON PANNELLI BURLINGTON

## IRIS | FINITURE PANNELLI E BORDO VASCA

### PANNELLI



Bianco lucido

### PANNELLI LEGNO



Bianco rigato



Grain



Burlington



Dolomite

## IRIS | FUNZIONI E DOTAZIONI (disponibili a seconda dell'allestimento)

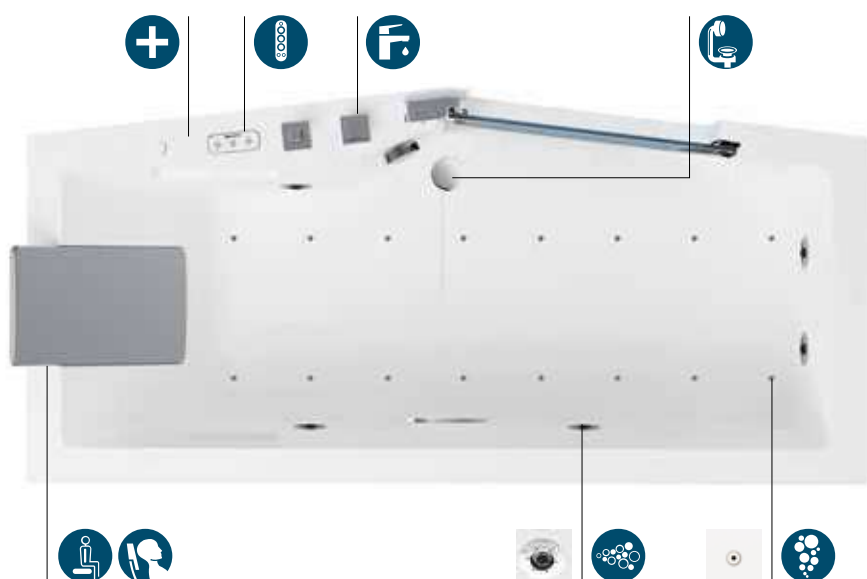

**Massaggio Airpool (16 jets)** a getto d'aria con accensione manuale on/off. Per una **efficace stimolazione cellulare**



**Massaggio corpo Whirlpool (6 jets)** aria/acqua. Per soddisfare qualsiasi esigenza di benessere.



**Poggiatesta** in materiale antibatterico



**Pannello elettronico** con funzioni Hydro sequence



**Rubinetteria bordo vasca**



**Colonna di scarico**



**Disinfezione**



**Sedile**



VASCA CON PANNELLI GRAIN

IRIS



Poggiatesta / Seduta removibile



Sportello con chiusura meccanica



Rubinetto meccanico a bordo vasca



L'idromassaggio Novellini per una piena espressione delle proprie risorse vitali



# IRIS

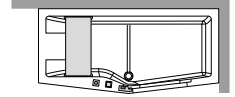
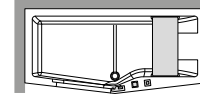

### PANNELLI IN ACRILICO

Misure			Capacità	Codice	Scelta rubinetteria + finitura vasca			Installazione		Scelta struttura / pannelli			
Cm	H	Lt.			Colonna di scarico senza rubinetteria	Colonna di scarico con erogazione da troppo pieno	Colonna di scarico + rubinetteria bordo vasca	Sinistra	Destra	Con telaio	1 Pannello	2 Pannelli	3 Pannelli
<b>STANDARD CON TELAIO</b>													
					C	E		S-	D-	A0	A1	A2	A3
160x70/80	62	250	IRI216070							3.212 €	3.477 €	3.609 €	3.742 €
170x70/80	62	265	IRI217080		+ 69 €	-							
180x75/85	62	305	IRI218085							3.553 €	3.818 €	3.950 €	4.083 €
<b>STANDARD CON TELAIO + RUBINETTERIA</b>													
							F	S-	D-	A0K	A1K	A2K	A3K
160x70/80	62	250	IRI216070				+ 458 €			3.212 €	3.477 €	3.609 €	3.742 €
170x70/80	62	265	IRI217080		-	-							
180x75/85	62	305	IRI218085							3.553 €	3.818 €	3.950 €	4.083 €
<b>HYDRO</b>													
					C	E	F	S-	D-	A0K	A1K	A2K	A3K
160x70/80	62	250	IRI316070T				+ 458 €			5.165 €	5.430 €	5.563 €	5.695 €
170x70/80	62	265	IRI317080T		+ 69 €								
180x75/85	62	305	IRI318085T							5.507 €	5.772 €	5.904 €	6.037 €
<b>HYDRO PLUS</b>													
					C	E	F	S-	D-	A0K	A1K	A2K	A3K
160x70/80	62	250	IRI416070T				+ 458 €			5.915 €	6.180 €	6.313 €	6.445 €
170x70/80	62	265	IRI417080T		+ 69 €								
180x75/85	62	305	IRI418085T							6.258 €	6.523 €	6.655 €	6.788 €

### PANNELLI IN LAMINATO

Misure			Capacità	Codice	Scelta rubinetteria + finitura vasca			Installazione		Scelta struttura / pannelli						
Cm	H	Lt.			Colonna di scarico senza rubinetteria	Colonna di scarico con erogazione da troppo pieno	Colonna di scarico + rubinetteria bordo vasca	Sinistra	Destra	1 Pannello	2 Pannelli	3 Pannelli	Bianco rigato	Grain	Burlington	Dolomite
<b>STANDARD CON TELAIO</b>																
					C	E		S-	D-	A1	A2	A3	I	M	N	X
160x70/80	62	250	IRI216070							3.497 €	3.639 €	3.782 €				
170x70/80	62	265	IRI217080		+ 69 €	-										
180x75/85	62	305	IRI218085							3.838 €	3.980 €	4.123 €				
<b>STANDARD CON TELAIO + RUBINETTERIA</b>																
							F	S-	D-	A1	A2	A3	I	M	N	X
160x70/80	62	250	IRI216070				+ 458 €			3.497 €	3.639 €	3.782 €				
170x70/80	62	265	IRI217080		-	-										
180x75/85	62	305	IRI218085							3.838 €	3.980 €	4.123 €				
<b>HYDRO</b>																
					C	E	F	S-	D-	A1	A2	A3	I	M	N	X
160x70/80	62	250	IRI316070T				+ 458 €			5.450 €	5.593 €	5.735 €				
170x70/80	62	265	IRI317080T		+ 69 €											
180x75/85	62	305	IRI318085T							5.792 €	5.934 €	6.077 €				
<b>HYDRO PLUS</b>																
					C	E	F	S-	D-	A1	A2	A3	I	M	N	X
160x70/80	62	250	IRI416070T				+ 458 €			6.200 €	6.343 €	6.485 €				
170x70/80	62	265	IRI417080T		+ 69 €											
180x75/85	62	305	IRI418085T							6.543 €	6.685 €	6.828 €				

# IRIS COMBY

VASCA CON ACCESSO FACILITATO, PANNELLI IN FINITURA LAMINATO

Dimensioni	Codice	Installazione		Prezzo
<b>IRIS COMBY - PARETE VASCA COMBINATA ANGOLARE</b>				
	Altezza	<b>D</b>	<b>S</b>	<b>1K</b>
	<b>Cm</b>	 Destra	 Sinistra	
	150	<b>IRIS2V80</b>	D-	S-

Pannello Fisso	Codice	D	S	1K	
	<b>Cm</b>	 Destra	 Sinistra		
	70	<b>IRIS2VF8070</b>	D-	S-	944 €
	75	<b>IRIS2VF8075</b>	D-	S-	972 €



PER TUTTI GLI OPTIONAL VEDI PAG. 553-554



VASCA BIANCO MORBIDO CON PANNELLI BIANCO RIGATO



VASCA BIANCO MORBIDO CON PANNELLI DOLOMITE

## CALOS 2.0 | FINITURE PANNELLI E BORDO VASCA

### PANNELLI



Bianco lucido

Bianco morbido

### PANNELLI LEGNO

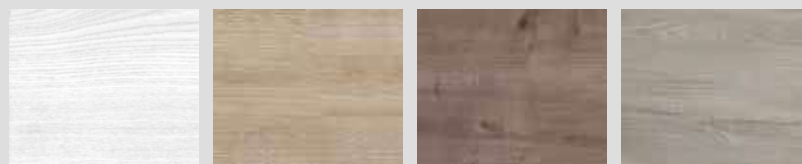

Bianco rigato

Grain

Burlington

Dolomite

## CALOS 2.0 | FUNZIONI E DOTAZIONI (disponibili a seconda dell'allestimento)

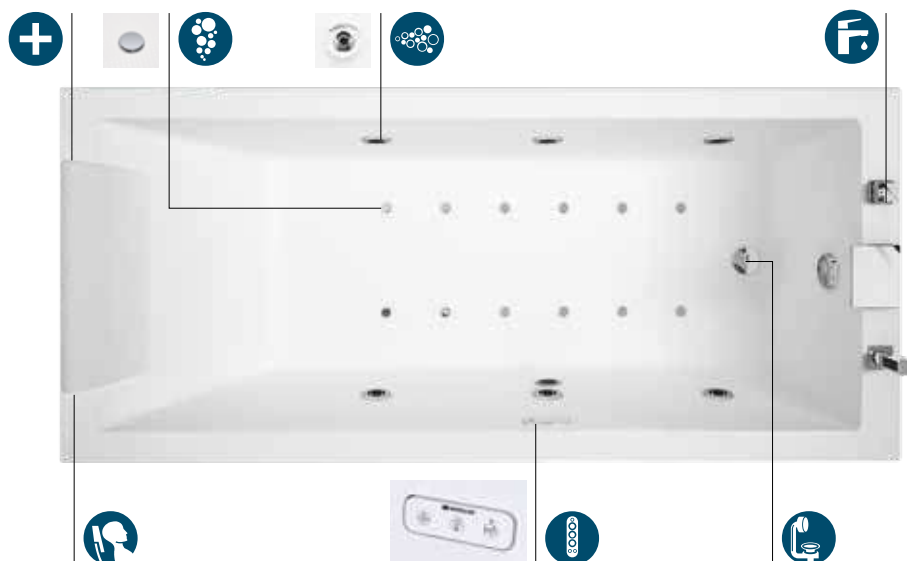

**Massaggio Airpool (12 jets)** a getto d'aria con accensione manuale on/off. Per una **efficace stimolazione cellulare**



**Massaggio corpo Whirlpool (6 jets)** aria/acqua. Per soddisfare qualsiasi esigenza di benessere.



**Pannello di controllo** con funzioni Hydro sequence



**Poggiatesta** in materiale antibatterico



**Rubinetteria bordo vasca**



**Colonna di scarico**



**Disinfezione**



VASCA BIANCO LUCIDO CON PANNELLI BURLINGTON

CALOS



Pannello elettronico con funzioni Hydro Sequence



Fondo liscio



L'idromassaggio Novellini per una piena espressione delle proprie risorse vitali



Nuova finitura Bianco Morbido



# CALOS

# CALOS

## VASCA RETTANGOLARE

Misure			Capacità	Codice	Scelta rubinetteria + finitura vasca				Scelta struttura/pannelli	
Cm	H	Lt.								
					Solo guscio Bianco lucido    Bianco morbido	Colonna di scarico senza rubinetteria Bianco lucido    Bianco morbido	Colonna di scarico con erogazione da troppo pieno Bianco lucido    Bianco morbido	Colonna di scarico + rubinetteria bordo vasca Bianco lucido    Bianco morbido	Solo struttura	Con pannelli
									Solo struttura	Con pannelli

STANDARD DA INCASSO										
					-A	-U				
150 x 70	58	155	<b>C2115070</b>	●	412 €	509 €				
160 x 70	58	170	<b>C2116070</b>	●						
170 x 70	58	185	<b>C2117070</b>	●						
170 x 75	58	200	<b>C2117075</b>	●						
170 x 80	58	215	<b>C2117080</b>	●						
180 x 80	58	235	<b>C2118080</b>	●						

STANDARD CON TELAIO													
						C-A	C-U	E-A	E-U	F-A	F-U	ØK	
150 x 70	58	155	<b>C2215070</b>										* Vedi tabella <b>SCELTA NUMERO PANNELLI + FINITURA PANNELLI</b>
160 x 70	58	170	<b>C2216070</b>										
170 x 70	58	185	<b>C2217070</b>	-	-	760 €	858 €	829 €	927 €	1.328 €	1.425 €		
170 x 75	58	200	<b>C2217075</b>										
170 x 80	58	215	<b>C2217080</b>										
180 x 80	58	235	<b>C2218080</b>										

HYDRO CON TELAIO SENZA DISINFEZIONE													
						C-A	C-U	E-A	E-U	F-A	F-U	ØK	
150 x 70	58	155	<b>C25150700</b>										* Vedi tabella <b>SCELTA NUMERO PANNELLI + FINITURA PANNELLI</b>
160 x 70	58	170	<b>C25160700</b>										
170 x 70	58	185	<b>C25170700</b>	-	-	1.690 €	1.788 €	1.759 €	1.857 €	2.258 €	2.355 €		
170 x 75	58	200	<b>C25170750</b>										
170 x 80	58	215	<b>C25170800</b>										
180 x 80	58	235	<b>C25180800</b>										

HYDRO CON TELAIO E DISINFEZIONE															
						C-A	C-U	E-A	E-U	F-A	F-U	ØK			
150 x 70	58	155	<b>C2315070P</b>										* Vedi tabella <b>SCELTA NUMERO PANNELLI + FINITURA PANNELLI</b>		
160 x 70	58	170	<b>C2316070P</b>												
170 x 70	58	185	<b>C2317070P</b>	-	-	2.145 €	2.243 €	2.214 €	2.312 €	2.713 €	2.810 €				
170 x 75	58	200	<b>C2317075P</b>												
170 x 80	58	215	<b>C2317080P</b>												
180 x 80	58	235	<b>C2318080P</b>												

HYDRO PLUS CON TELAIO															
						C-A	C-U	E-A	E-U	F-A	F-U	ØK			
150 x 70	58	155	<b>C2415070P</b>										* Vedi tabella <b>SCELTA NUMERO PANNELLI + FINITURA PANNELLI</b>		
160 x 70	58	170	<b>C2416070P</b>												
170 x 70	58	185	<b>C2417070P</b>	-	-	3.215 €	3.313 €	3.284 €	3.382 €	3.783 €	3.880 €				
170 x 75	58	200	<b>C2417075P</b>												
170 x 80	58	215	<b>C2417080P</b>												
180 x 80	58	235	<b>C2418080P</b>												

PER TUTTI GLI OPTIONAL VEDI PAG. 553-554





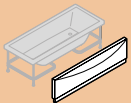
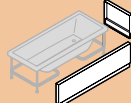
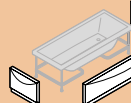

**\* SCELTA NUMERO PANNELLI + FINITURA PANNELLI**

		
1 pannello	2 pannelli	3 pannelli

**ACRILICO**

1A	1U	2A	2U	3A	3U
Bianco lucido	Bianco morbido	Bianco lucido	Bianco morbido	Bianco lucido	Bianco morbido
+ 273 €	+ 328 €	+ 385 €	+ 468 €	+ 500 €	+ 610 €

**LEGNI**

1 pannello				2 pannelli				3 pannelli			
1I	1M	1N	1X	2I	2M	2N	2X	3I	3M	3N	3X
Bianco rigato	Grain	Burlington	Dolomite	Bianco rigato	Grain	Burlington	Dolomite	Bianco rigato	Grain	Burlington	Dolomite
+ 355 €				+ 515 €				+ 715 €			

Costruzione del codice vasca senza pannelli

**Codice** + **Scelta scarico/erogazione + Finitura vasca** + **Scelta struttura senza pannelli** = Codice prodotto finale

Costruzione del codice vasca con pannelli

**Codice** + **Scelta scarico/erogazione + Finitura vasca** + **Scelta struttura con pannelli (acrilico o legni)** = Codice prodotto finale

# CALYPSO

## VASCA RETTANGOLARE

Misure			Capacità	Codice	Scelta rubinetteria + finitura vasca			Installazione		Scelta struttura			
Cm	H	Lt.			Colonna di scarico senza rubinetteria	Colonna di scarico con erogazione da troppo pieno	Colonna di scarico + rubinetteria bordo vasca	Sinistra	Destra	Con telaio	1 Pannello	2 Pannelli	3 Pannelli
<b>STANDARD DA INCASSO</b>													
150 x 70	55	150	<b>CAL115070-A</b>							 274 €			
160 x 70	55	160	<b>CAL116070-A</b>										
170 x 70	55	170	<b>CAL117070-A</b>	-	-	-	-	-					
170 x 75	55	180	<b>CAL117075-A</b>										
170 x 80	55	190	<b>CAL117080-A</b>										
180 x 80	55	200	<b>CAL118080-A</b>										
<b>STANDARD CON TELAIO</b>													
				<b>C-</b>	<b>E-</b>	<b>F-</b>				<b>A0</b>	<b>A1</b>	<b>A2</b>	<b>A3</b>
150 x 70	55	150	<b>CAL215070</b>										
160 x 70	55	160	<b>CAL216070</b>										
170 x 70	55	170	<b>CAL217070</b>		+ 69 €	+ 568 €	-	-	500 €	678 €	754 €	829 €	
170 x 75	55	180	<b>CAL217075</b>										
170 x 80	55	190	<b>CAL217080</b>										
180 x 80	55	200	<b>CAL218080</b>										
<b>HYDRO CON TELAIO SENZA DISINFEZIONE</b>													
				<b>C</b>	<b>E</b>	<b>F</b>	<b>S-</b>	<b>D-</b>		<b>A0K</b>	<b>A1K</b>	<b>A2K</b>	<b>A3K</b>
150 x 70	55	150	<b>CAL5150700</b>										
160 x 70	55	160	<b>CAL5160700</b>										
170 x 70	55	170	<b>CAL5170700</b>		+ 69 €	+ 568 €			1.102 €	1.279 €	1.355 €	1.432 €	
170 x 75	55	180	<b>CAL5170750</b>										
170 x 80	55	190	<b>CAL5170800</b>										
180 x 80	55	200	<b>CAL5180800</b>										
<b>HYDRO CON TELAIO E DISINFEZIONE</b>													
				<b>C</b>	<b>E</b>	<b>F</b>	<b>S-</b>	<b>D-</b>		<b>A0K</b>	<b>A1K</b>	<b>A2K</b>	<b>A3K</b>
150 x 70	55	150	<b>CAL315070P</b>										
160 x 70	55	160	<b>CAL316070P</b>										
170 x 70	55	170	<b>CAL317070P</b>		+ 69 €	+ 568 €			1.395 €	1.573 €	1.649 €	1.724 €	
170 x 75	55	180	<b>CAL317075P</b>										
170 x 80	55	190	<b>CAL317080P</b>										
180 x 80	55	200	<b>CAL318080P</b>										
<b>HYDRO PLUS CON TELAIO</b>													
				<b>C</b>	<b>E</b>	<b>F</b>	<b>S-</b>	<b>D-</b>		<b>A0K</b>	<b>A1K</b>	<b>A2K</b>	<b>A3K</b>
150 x 70	55	150	<b>CAL415070P</b>										
160 x 70	55	160	<b>CAL416070P</b>										
170 x 70	55	170	<b>CAL417070P</b>		+ 69 €	+ 568 €			2.092 €	2.269 €	2.345 €	2.420 €	
170 x 75	55	180	<b>CAL417075P</b>										
170 x 80	55	190	<b>CAL417080P</b>										
180 x 80	55	200	<b>CAL418080P</b>										
<b>ECO CON TELAIO SENZA DISINFEZIONE</b>													
				<b>C</b>	<b>E</b>	<b>F</b>	<b>S-</b>	<b>D-</b>		<b>A0K</b>	<b>A1K</b>	<b>A2K</b>	<b>A3K</b>
150 x 70	55	150	<b>CAL615070MCS-</b>										
160 x 70	55	160	<b>CAL616070MCS-</b>										
170 x 70	55	170	<b>CAL617070MCS-</b>	-	-	-	-	-	-	-	-	1.115 €	
170 x 75	55	180	<b>CAL617075MCS-</b>										
170 x 80	55	190	<b>CAL617080MCS-</b>										
180 x 80	55	200	<b>CAL618080MCS-</b>										

PER TUTTI GLI OPTIONAL VEDI PAG. 553-554





FINITURA  
VASCA



Bianco  
lucido

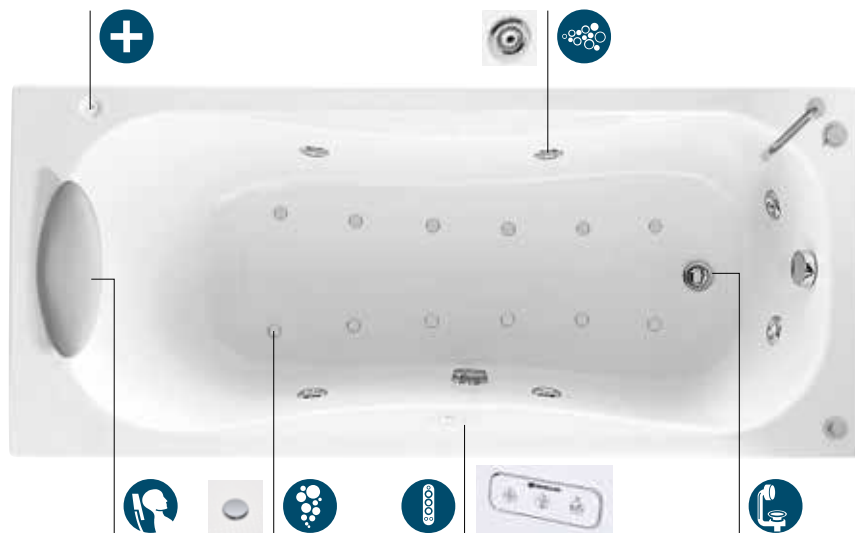

SINISTRA

DESTRA

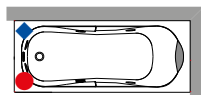
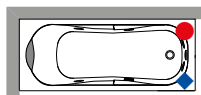

#### VERSIONE STANDARD

- RUBINETTERIA
- ◆ DOCCETTA

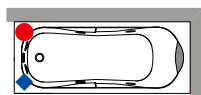
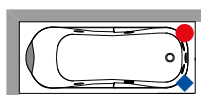

#### VERSIONE HYDRO

- RUBINETTERIA
- ◆ DOCCETTA

## FUNZIONI E DOTAZIONI

(disponibili a seconda dell'allestimento)



**Massaggio Airpool (12 jets)** a getto d'aria con accensione manuale on/off. Per una **efficace stimolazione cellulare**



**Massaggio corpo Whirlpool (6 jets)** aria/acqua. Per soddisfare qualsiasi esigenza di benessere.



**Poggiatesta** in materiale antibatterico



**Pannello di controllo** con funzioni Hydro sequence



**Piletta di scarico**



**Disinfezione**













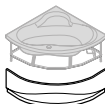

CALYPSO

# CALYPSO



# UNA

## VASCA ANGOLARE SIMMETRICA SEMICIRCOLARE

Misure		Capacità		Codice	Scelta rubinetteria + finitura vasca			Scelta struttura / prezzo	
Cm	H	Lt.			Colonna di scarico senza rubinetteria	Colonna di scarico con erogazione da troppo pieno	Colonna di scarico + rubinetteria bordo vasca	Con telaio	1 Pannello
									
<b>STANDARD DA INCASSO</b>									
135 x 135	55	190	<b>UNA1135135</b>	-	-	-	<b>-A</b>	785 €	-
<b>STANDARD CON TELAIO</b>									
135 x 135	55	190	<b>UNA2135135</b>	<b>C-</b>	<b>E-</b>	<b>F-</b>	<b>A0</b>	<b>A1</b>	
					+ 70 €	+ 578 €	1.244 €	1.555 €	
<b>HYDRO CON TELAIO SENZA DISINFEZIONE</b>									
135 x 135	55	190	<b>UNA51351350</b>	<b>C-</b>	<b>E-</b>	<b>F-</b>	<b>A0K</b>	<b>A1K</b>	 
					+ 70 €	+ 578 €	2.145 €	2.457 €	
<b>HYDRO CON TELAIO E DISINFEZIONE</b>									
135 x 135	55	190	<b>UNA3135135P</b>	<b>C-</b>	<b>E-</b>	<b>F-</b>	<b>A0K</b>	<b>A1K</b>	   
					+ 70 €	+ 578 €	2.647 €	2.958 €	
<b>HYDRO PLUS CON TELAIO</b>									
135 x 135	55	190	<b>UNA4135135P</b>	<b>C-</b>	<b>E-</b>	<b>F-</b>	<b>A0K</b>	<b>A1K</b>	    
					+ 70 €	+ 578 €	4.052 €	4.363 €	

PER TUTTI GLI OPTIONAL VEDI PAG. 553-554



FINITURA  
VASCA



Bianco  
lucido

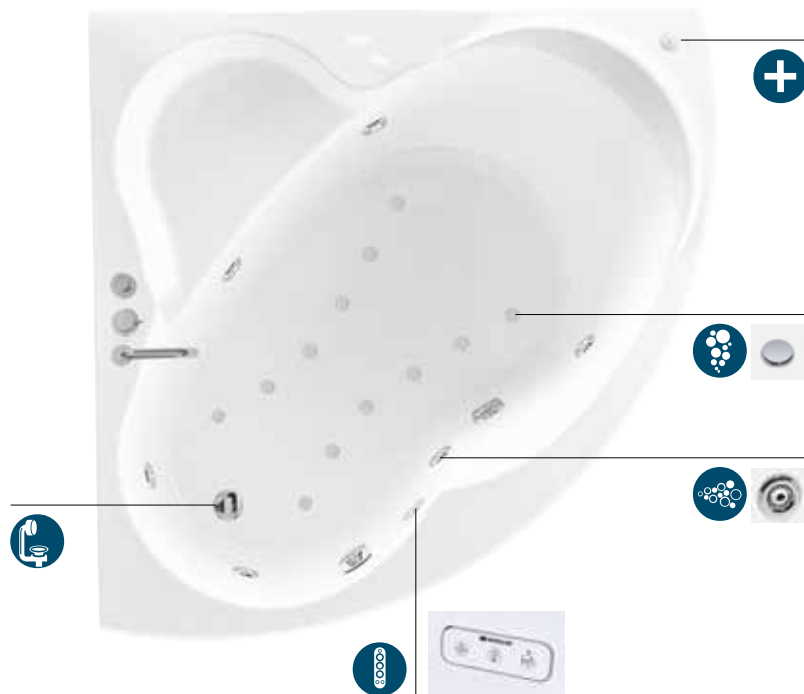

## FUNZIONI E DOTAZIONI

(disponibili a seconda dell'allestimento)



**Massaggio Airpool (12 jets)** a getto d'aria con accensione manuale on/off. Per una **efficace stimolazione cellulare**



**Massaggio corpo Whirlpool (6 jets)** aria/acqua. Per soddisfare qualsiasi esigenza di benessere.



**Pannello di controllo** con funzioni Hydro sequence



**Colonna di scarico**



**Disinfezione**



# UNA

# VOGUE

## VASCA ANGOLARE ASIMMETRICA SEMICIRCOLARE

Misure		Capacità		Codice	Scelta rubinetteria + finitura vasca			Installazione		Scelta pannelli	
Cm	H	Lt.			Colonna di scarico senza rubinetteria	Colonna di scarico con erogazione da troppo pieno	Colonna di scarico + rubinetteria bordo vasca	Sinistra	Destra	Con telaio	1 Pannello
											

STANDARD DA INCASSO										
				C	E	F	S-A	D-A		
150 X 85	55	140	<b>VOG115085</b>	-	-	-	785 €	785 €		
165 X 85	55	180	<b>VOG116585</b>	-	-	-				

STANDARD CON TELAIO										
				C	E	F	S-	D-	A0	A1
150 X 85	55	140	<b>VOG215085</b>		+ 70 €	+ 578 €			1.244 €	1.555 €
165 X 85	55	180	<b>VOG216585</b>							

HYDRO CON TELAIO SENZA DISINFEZIONE										
				C	E	F	S-	D-	A0K	A1K
150 X 85	55	140	<b>VOG5150850</b>		+ 70 €	+ 578 €			2.145 €	2.457 €
165 X 85	55	180	<b>VOG5165850</b>							

HYDRO CON TELAIO E DISINFEZIONE										
				C	E	F	S-	D-	A0K	A1K
150 X 85	55	140	<b>VOG315085P</b>		+ 70 €	+ 578 €			2.647 €	2.958 €
165 X 85	55	180	<b>VOG316585P</b>							

HYDRO PLUS CON TELAIO										
				C	E	F	S-	D-	A0K	A1K
150 X 85	55	140	<b>VOG415085P</b>		+ 70 €	+ 578 €			4.052 €	4.363 €
165 X 85	55	180	<b>VOG416585P</b>							

ECO CON TELAIO SENZA DISINFEZIONE										
				C	E	F	S-	D-	A0K	A1K
150 X 85	55	140	<b>VOG615085MC</b>	-	-	-			-	1.880 €
165 X 85	55	180	<b>VOG616585MC</b>	-	-	-			-	

PER TUTTI GLI OPTIONAL VEDI PAG. 553-554





FINITURA  
VASCA



Bianco  
lucido



## FUNZIONI E DOTAZIONI

(disponibili a seconda dell'allestimento)



**Massaggio Airpool (12 jets)** a getto d'aria con accensione manuale on/off. Per una **efficace stimolazione cellulare**



**Massaggio corpo Whirlpool (6 jets)** aria/acqua. Per soddisfare qualsiasi esigenza di benessere.



**Pannello di controllo** con funzioni Hydro sequence



**Poggiatesta** in materiale antibatterico



**Colonna di scarico**



**Disinfezione**

# VOGUE



# VENUS

## VASCA ANGOLARE

Misure		Capacità		Codice	Scelta rubinetteria + finitura vasca			Installazione		Scelta pannelli	
Cm	H	Lt.			Colonna di scarico senza rubinetteria	Colonna di scarico con erogazione da troppo pieno	Colonna di scarico + rubinetteria bordo vasca	Sinistra	Destra	Con telaio	1 Pannello

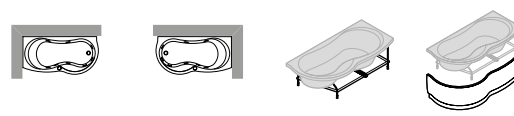

STANDARD DA INCASSO					S-A	D-A	
170 x 70	55	190	<b>VEN117070</b>				
180 x 80	55	200	<b>VEN118080</b>	-	-	-	

STANDARD CON TELAIO					C	E	F	S-	D-	A0	A1
170 x 70	55	190	<b>VEN217070</b>							1.244 €	1.555 €
180 x 80	55	200	<b>VEN218080</b>		+ 70 €	+ 578 €					

HYDRO CON TELAIO SENZA DISINFEZIONE					C	E	F	S-	D-	A0K	A1K
170 x 70	55	190	<b>VEN517070</b>							2.145 €	2.457 €
180 x 80	55	200	<b>VEN518080</b>		+ 70 €	+ 578 €					

HYDRO CON TELAIO E DISINFEZIONE					C	E	F	S-	D-	A0K	A1K
170 x 70	55	190	<b>VEN317070P</b>							2.647 €	2.958 €
180 x 80	55	200	<b>VEN318080P</b>		+ 70 €	+ 578 €					

HYDRO PLUS CON TELAIO					C	E	F	S-	D-	A0K	A1K
170 x 70	55	190	<b>VEN417070P</b>							4.052 €	4.363 €
180 x 80	55	200	<b>VEN418080P</b>		+ 70 €	+ 578 €					

PER TUTTI GLI OPTIONAL VEDI PAG. 553-554





FINITURA  
VASCA



Bianco  
lucido



## FUNZIONI E DOTAZIONI

(disponibili a seconda dell'allestimento)



**Massaggio Airpool (12 jets)** a getto d'aria con accensione manuale on/off. Per una **efficace stimolazione cellulare**



**Massaggio corpo Whirlpool (6 jets)** aria/acqua. Per soddisfare qualsiasi esigenza di benessere.



**Pannello di controllo** con funzioni Hydro sequence



**Colonna di scarico**



**Disinfezione**

# VENUS



# BABY

## VASCA RETTANGOLARE AD INCASSO



FINITURA  
VASCA



Bianco  
lucido

Misure	Capacità	Codice	Prezzo	
Cm	Lt			
<b>BABY AD INCASSO</b>				
140 x 70 x 40 H	100	<b>BAB14070-A</b>	425 €	

BABY AD INCASSO

<b>BABY TWO - AD INCASSO</b>				
105 x 70 x 46	61	<b>BAT10570-A</b>	425 €	
120 x 70 x 45	81	<b>BAT12070-A</b>		



BABY



BABY TWO

## OPTIONAL PER VASCHE

### POGGIATESTA IN EVA\*

per Divina e Divina O

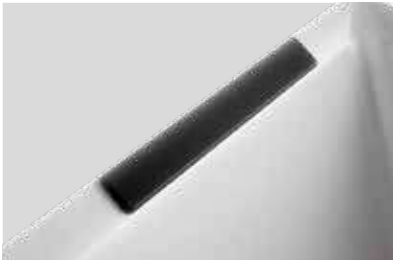

Codice

Prezzo

**POGDIV**

127 €

### POGGIATESTA IN EVA \*

per Divina C

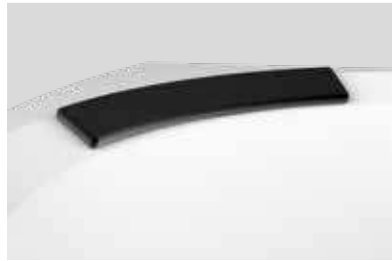

Codice

Prezzo

**POGDIVC**

127 €

### POGGIATESTA IN EVA\*

per Iris versione in nicchia



Codice

Prezzo

**POGIRIN**

155 €

### POGGIATESTA IN EVA\*

per Calos 2.0



Codice

Prezzo

**POGCA1**

70 €

### POGGIATESTA IN EVA \*

per Calypso



Codice

Prezzo

**POGCAL**

70 €

### POGGIATESTA IN EVA\*

per Vogue



Codice

Prezzo

**POGVOG**

70 €

### MENSOLINA PORTAOGGETTI BORDO VASCA

per Divina, Divina C, O, F e W



Codice

Prezzo

**R90PODIV**

210 €

### PIANO PORTAOGGETTI SOPRA VASCA

per Divina e Divina F



Larghezza

Codice

Prezzo

70 cm

**R90VADIV70**

350 €

75 cm

**R90VADIV75**

350 €

80 cm

**R90VADIV80**

350 €

90 cm

**R90VADIV90**

350 €

### PROFILO DI FINITURA RIGIDO IN ALLUMINIO



Misure

Codice

Prezzo

1 lato 185 cm

**PRV185-30**

84 €

2 lati 185x85 cm

**PRV18585-30**

108 €

3 lati 85x185x85 cm

**PRV8518585-30**

128 €

\*EVA è un materiale atossico, antibatterico e idrorepellente

## OPTIONAL PER VASCHE

### PROFILO DI FINITURA I. 400 cm



Codice	Prezzo
<b>PRVA2-A</b>	92 €

### PROFILO DI FINITURA IN PLASTICA



Codice	Prezzo
<b>PRVA195-30</b>	74 €

### TUBO DI SCARICO SALVAGOCCIA



STILE, IRIS, CALOS 2.0, UNA, VOGUE, VENUS, CALYPSO

Codice	Prezzo
<b>R90SCDOCBV</b>	139 €

SENSE, DIVINA

Codice	Prezzo
<b>R90SGCVSEDI</b>	139 €

### COLONNA DI SCARICO per vasche senza erogatore



SENSE

Codice	Prezzo
<b>COLSCAVK-K</b>	99 €

CALYPSO, VOGUE, VENUS, CALOS 2.0

Codice	Prezzo
<b>COLSCA-K</b>	99 €

### COLONNA DI SCARICO CON EROGATORE per vasche con erogatore



Codice	Prezzo
<b>COLSCAE-K</b>	128 €

### PANNELLO D'ISPEZIONE PER VASCA AD INCASSO 60x33x2 cm



SENSE

Codice	Prezzo
<b>PANISPEL-A</b>	167 €

IRIS, CALOS 2.0, UNA, VOGUE, VENUS, CALYPSO, BABY

Codice	Prezzo
<b>PANISP-A</b>	167 €

### KIT PIEDINI REGOLABILI PER VASCHE AD INCASSO per Sense, Iris, Calos 2.0



Codice	Prezzo
<b>PIEDVASCA</b>	64 €

### KIT PIEDINI REGOLABILI per Divina, Calos 2.0, Una, Vogue, Venus, Calypso



Codice	Prezzo
<b>PIEDVASCA70</b>	70 €
<b>PIEDVASCA75</b>	70 €
<b>PIEDVASCA80</b>	70 €
<b>PIEDVASCA90</b>	70 €
<b>PIEDVASCA100</b>	70 €

### KIT SOPRAVASCA DIVINA



Per il sopravasca Divina ordinare:

**1 sopravasca Young 2.0 1V/1BSV +  
1 kit raccordo vasca**

vedi pag. 586, 588

# KIT HYDROSILENCE



## DIVINA DUAL

Misure	Struttura	Codice	Prezzo
190 x 140	1 Pannello	<b>KUSDIV1F19014</b>	320 €
190 x 140	2 Pannelli	<b>KUSDIV1FL19014</b>	355 €
190 x 140	3 Pannelli	<b>KUSDIV1F2L19014</b>	394 €
190 x 140	4 Pannelli	<b>KUSDIV2F2L19014</b>	440 €

## DIVINA C

Misure	Struttura	Codice	Prezzo
140 x 140	1 Pannello	<b>KUSDIVC</b>	252 €

## DIVINA O

Misure	Struttura	Codice	Prezzo
165 X 98	1 Pannello	<b>KUSDIVO</b>	284 €

## DIVINA 160/170 - SENSE 3-4

Misure	Struttura	Codice	Prezzo
160/170	4 Pannelli	<b>KUSDIV2F2L160</b>	304 €

## DIVINA 180/190 - SENSE 3-4

Misure	Struttura	Codice	Prezzo
180/190	4 Pannelli	<b>KUSDIV2F2L190</b>	310 €

## DIVINA - SENSE 3-4

Struttura	Codice	Prezzo
3 Pannelli	<b>KUSDIV1F2L</b>	265 €

## DIVINA - SENSE 3-4 ANGOLO

Struttura	Codice	Prezzo
2 Pannelli	<b>KUSDIV1F1L</b>	239 €

## DIVINA - SENSE 3-4 NICCHIA

Struttura	Codice	Prezzo
1 Pannello	<b>KUSDIV1F</b>	227 €

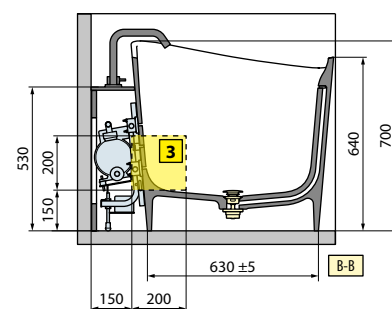
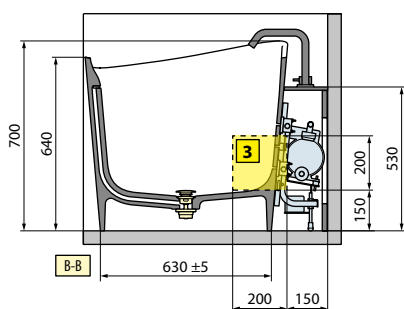
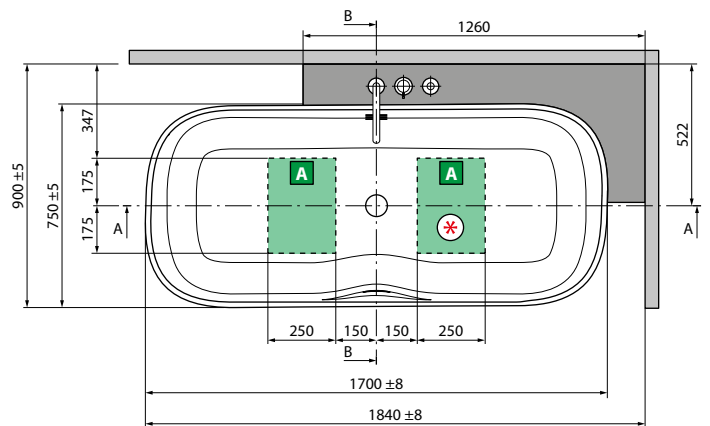
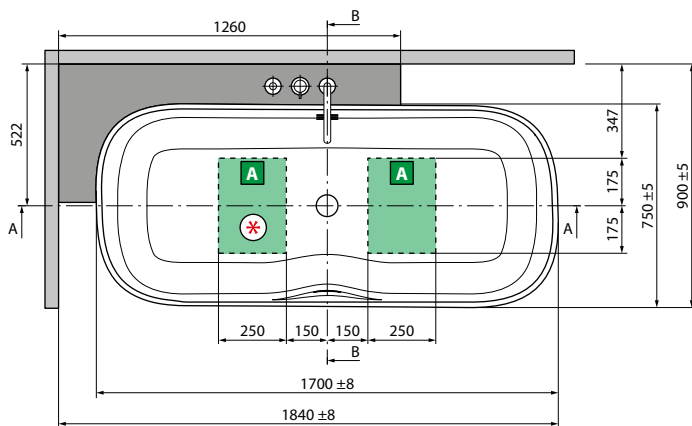
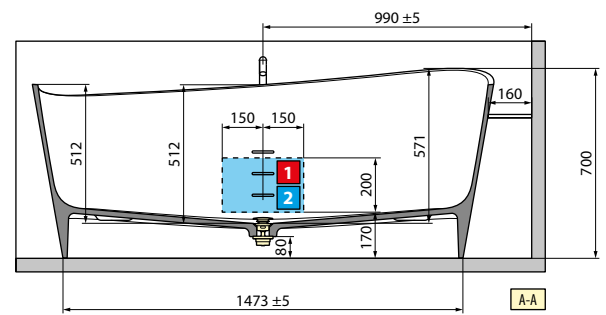
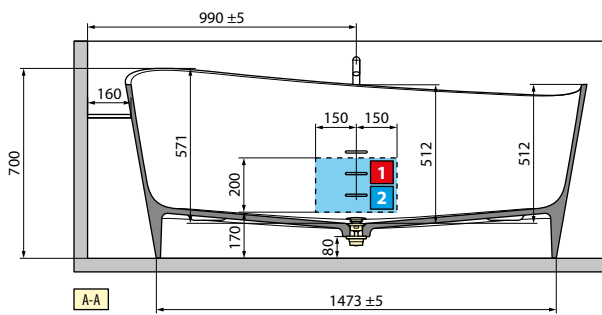
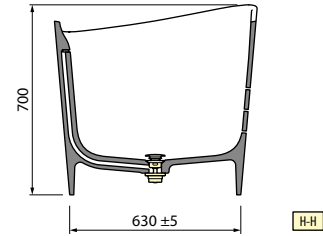
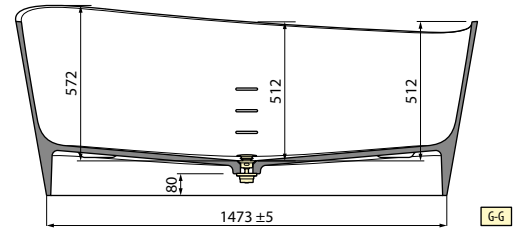
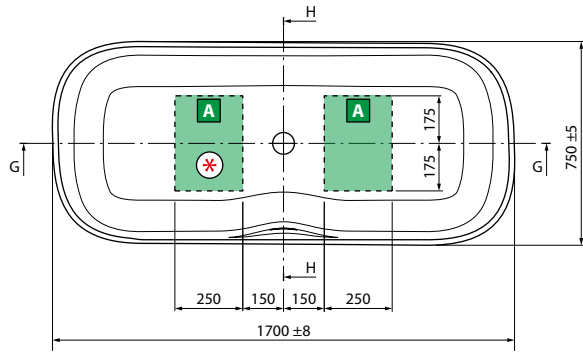

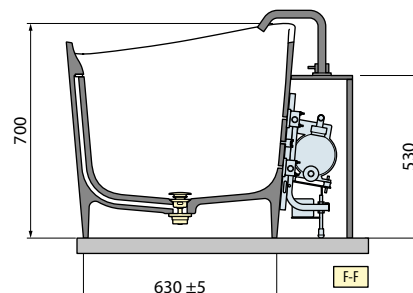
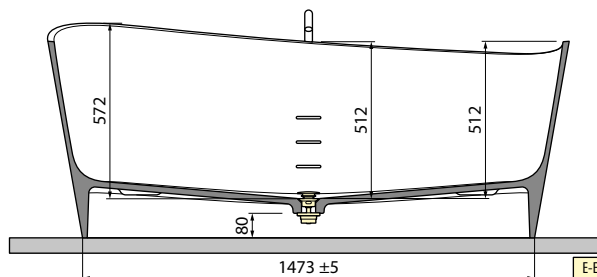
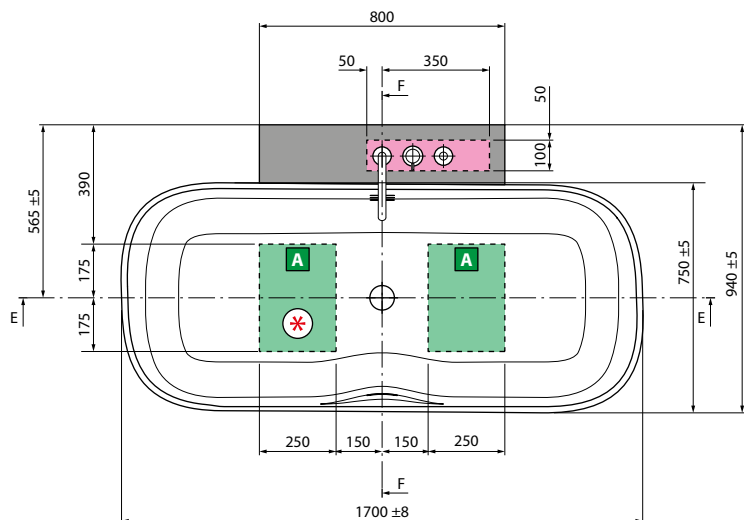
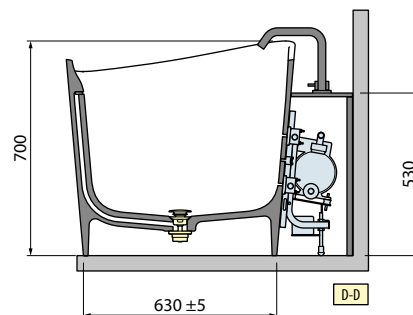
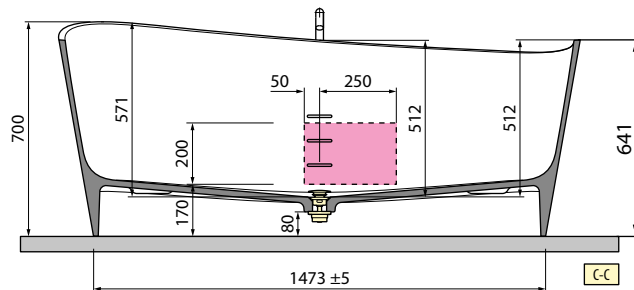
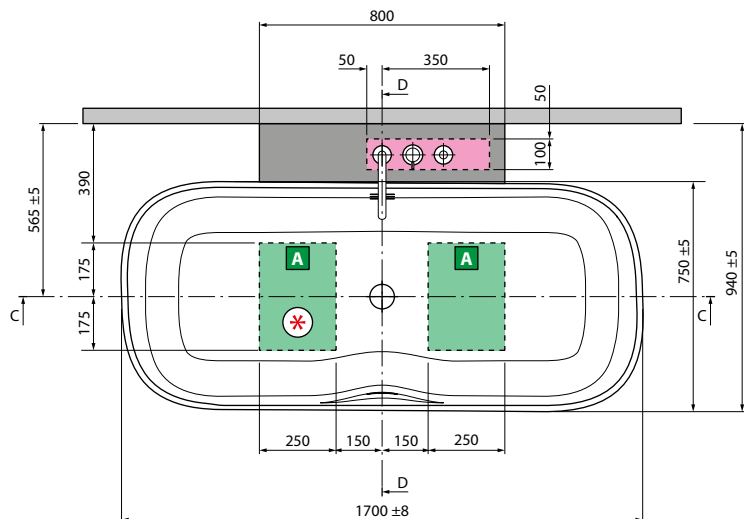

\* Zona per la predisposizione di allaccio elettrico nel caso di luce perimetrale vasca. Prevedere comandoremoto per l' accensione e lo spegnimento (non fornito).

MODELLO	PESO	CAPACITÀ LITRI
Infinite	135 kg	360 lt

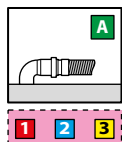

**CARATTERISTICHE IDRAULICHE**  
 1 bocchetta Natural Air  
 Sifone con attacco 40 mm

**CARATTERISTICHE ELETTRICHE**  
 Tensione 220-230 V  
 Frequenza 50 Hz  
 Potenza massima assorbita:  
 Natural Air: 1050 W

Installare a monte dell'apparecchio un interruttore differenziale da 30mA provvisto di interruttore onnipolare con apertura minima dei contatti ≥ 3 mm.

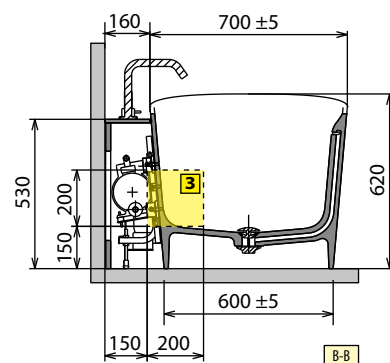
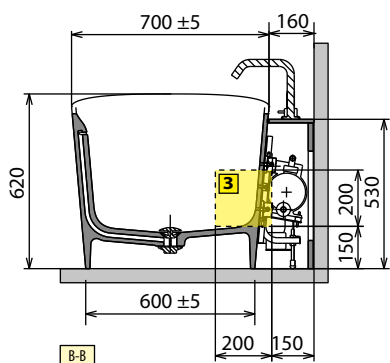
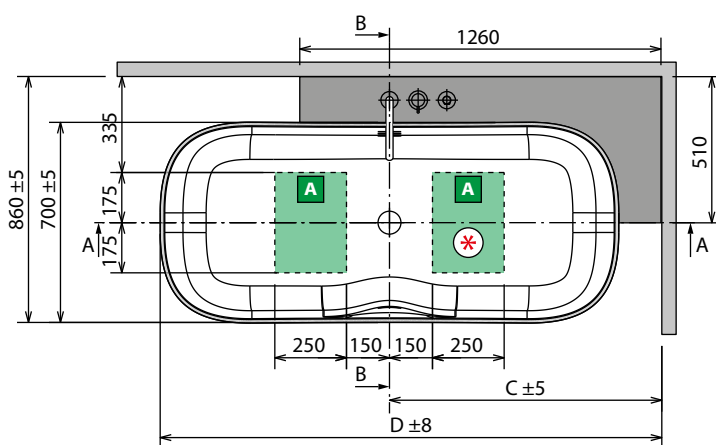
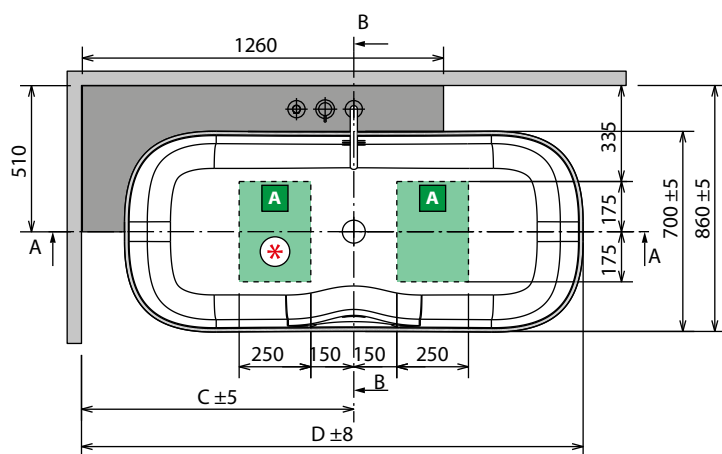
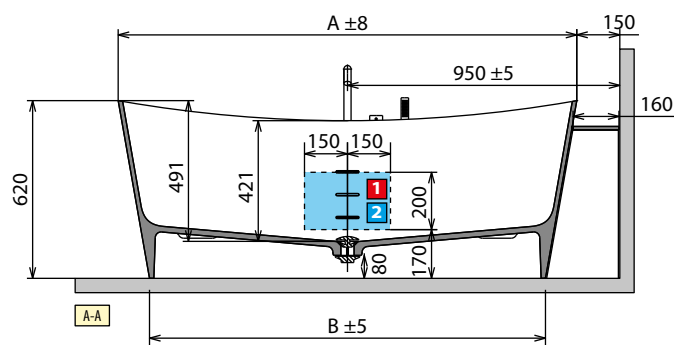
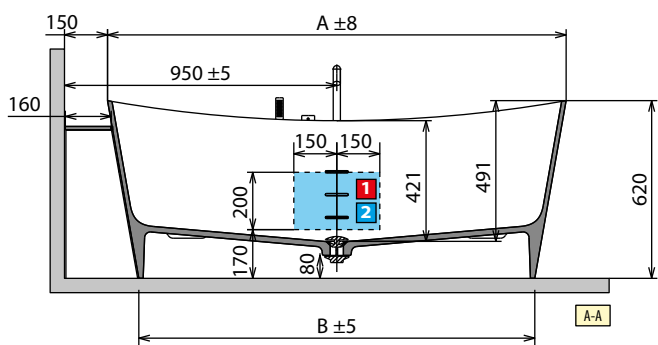
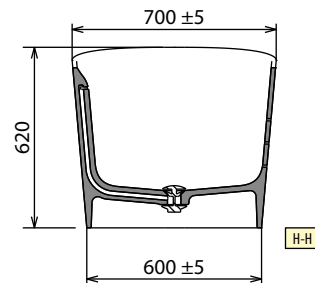
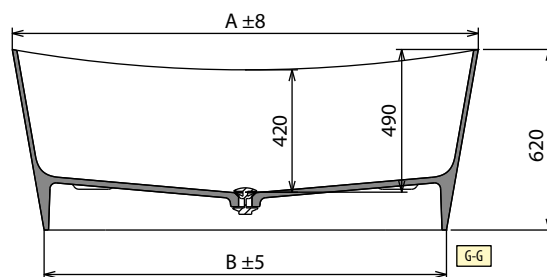
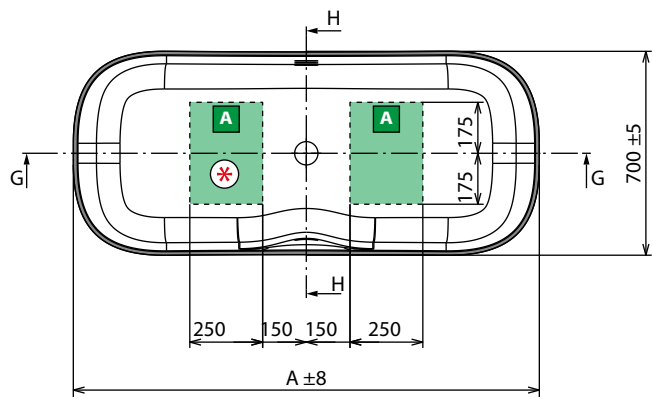



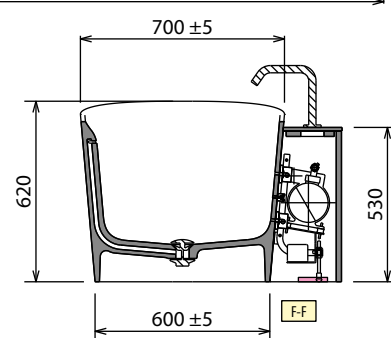
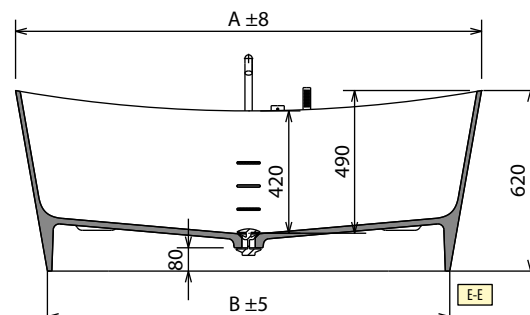
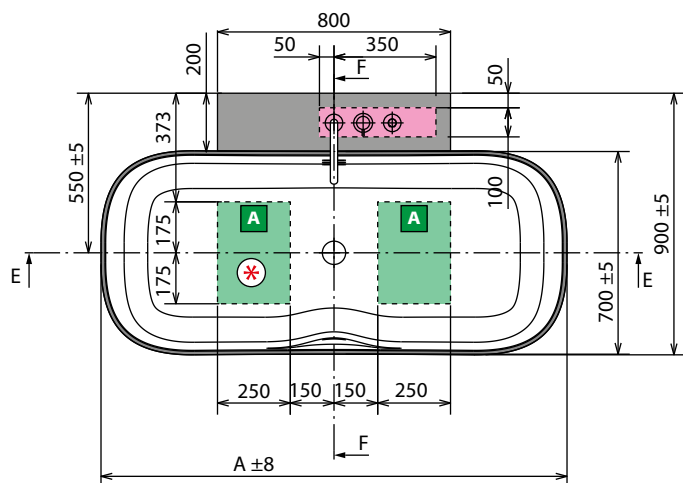
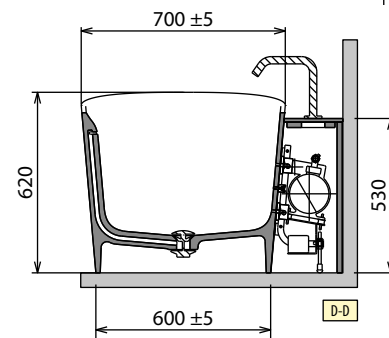
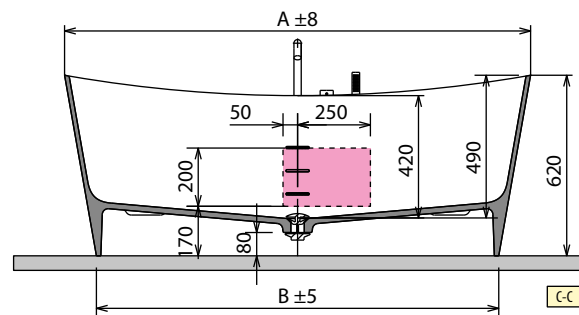
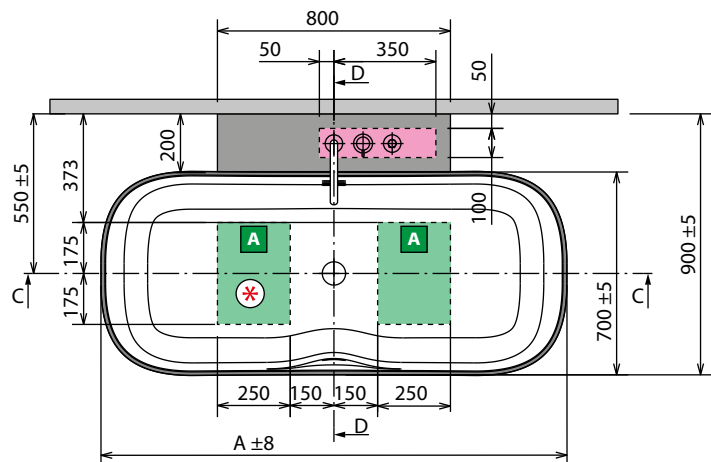

\* Zona per la predisposizione di allaccio elettrico nel caso di luce perimetrale vasca. Prevedere comandoremoto per l'accensione e lo spegnimento (non fornito).

MODELLO	A	B	C	D	PESO	CAPACITÀ LITRI
Ship 150	1500 mm	1280 mm	900 mm	1650 mm	105 kg	265 lt
Ship 160	1600 mm	1380 mm	950 mm	1750 mm	115 kg	280 lt

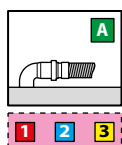

### CARATTERISTICHE IDRAULICHE

1 bocchetta Natural Air  
Sifone con attacco 40 mm

### CARATTERISTICHE ELETTRICHE

Tensione 220-230 V  
Frequenza 50 Hz  
Potenza massima assorbita:  
Natural Air: 1050 W

Installare a monte dell'apparecchio un interruttore differenziale da 30mA provvisto di interruttore onnipolare con apertura minima dei contatti ≥ 3 mm.

## VERSIONE SINISTRA

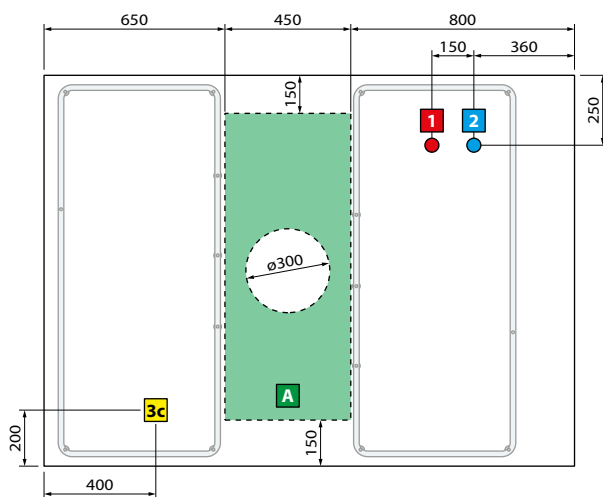
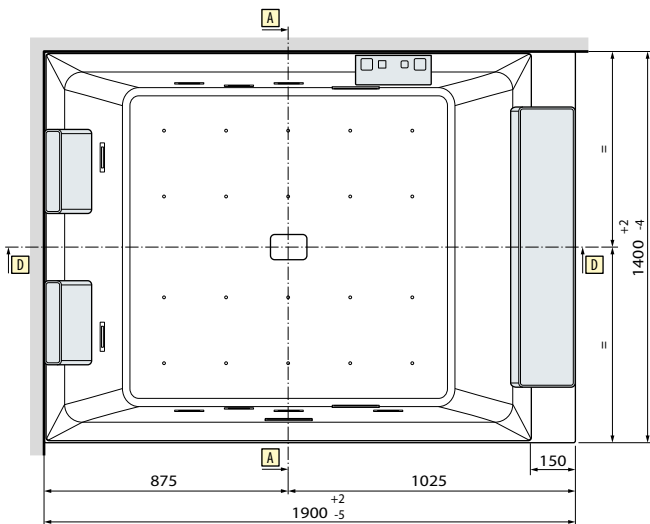
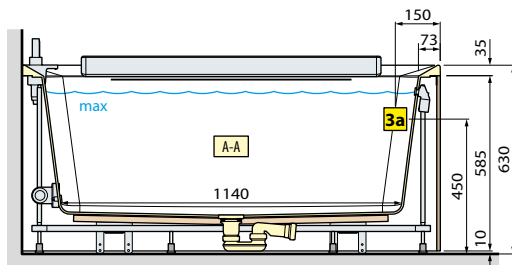
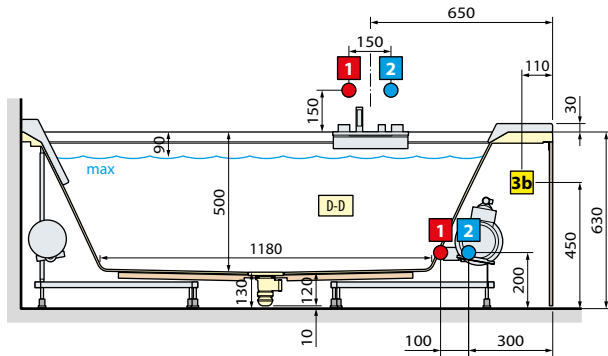

## VERSIONE DESTRA

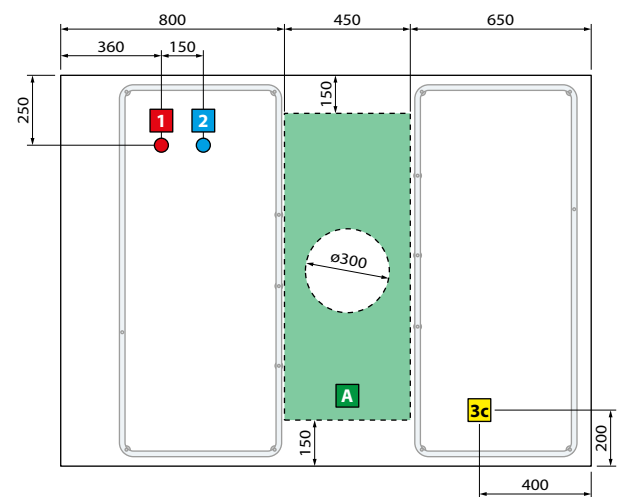
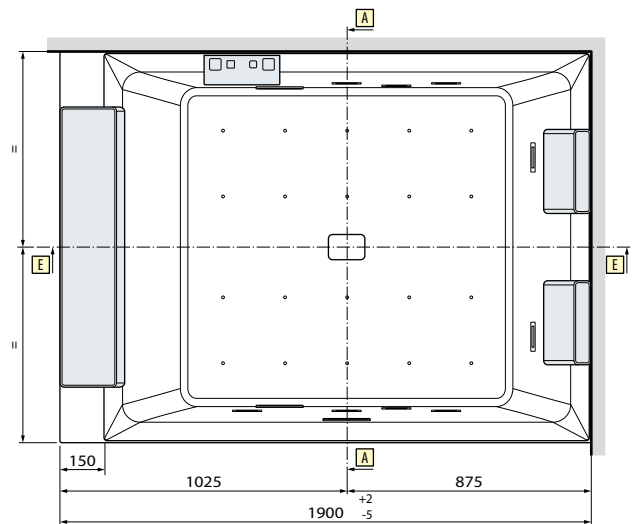
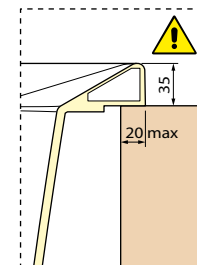
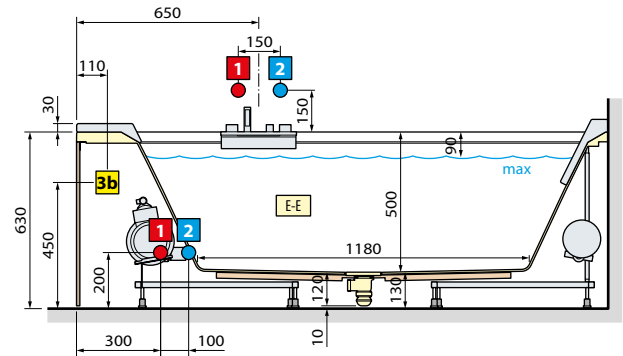

**ATTENZIONE!**  
Può essere dannoso ai portatori di pacemakers

Installare a monte dell'apparecchio un interruttore differenziale da 30mA provvisto di interruttore onnipolare con apertura minima dei contatti  $\geq 3$  mm.

SINISTRA

DESTRA

VERSIONE  
IN NICCHIA

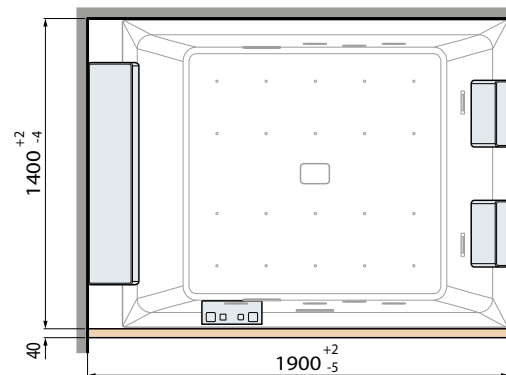
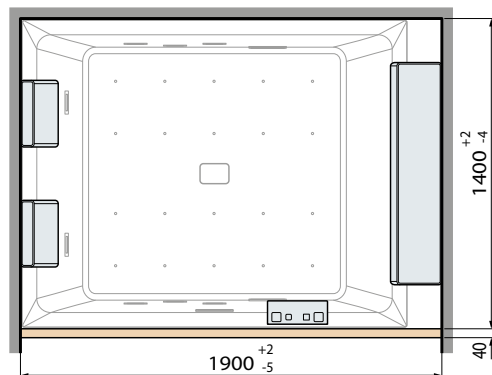

VERSIONE AD  
ANGOLO

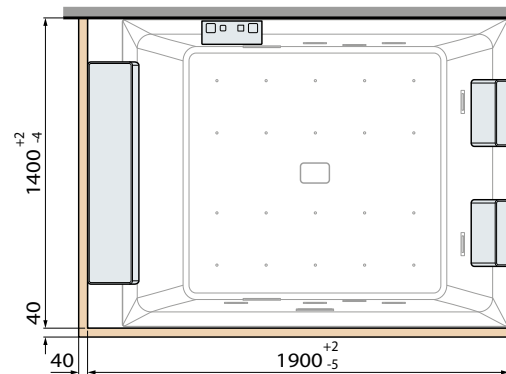
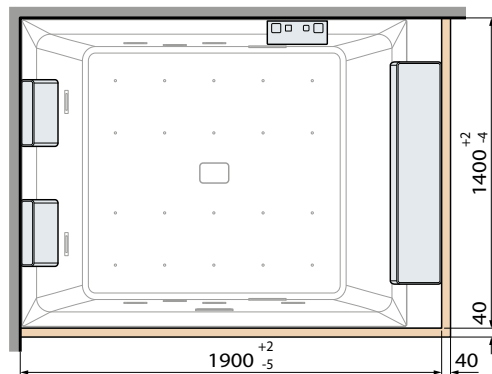

VERSIONE  
CENTRO PARETE

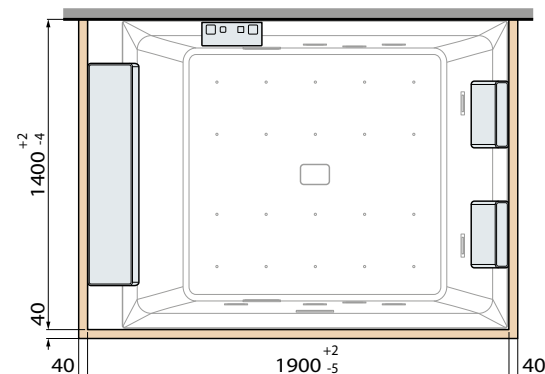
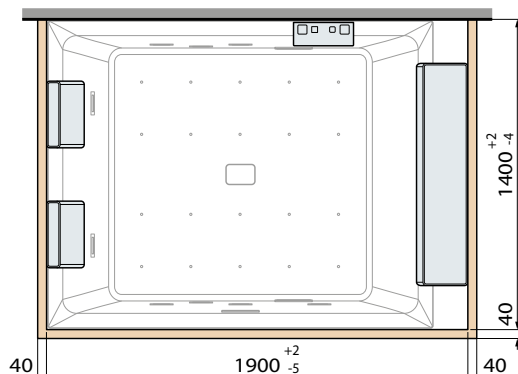

VERSIONE  
CENTRO STANZA

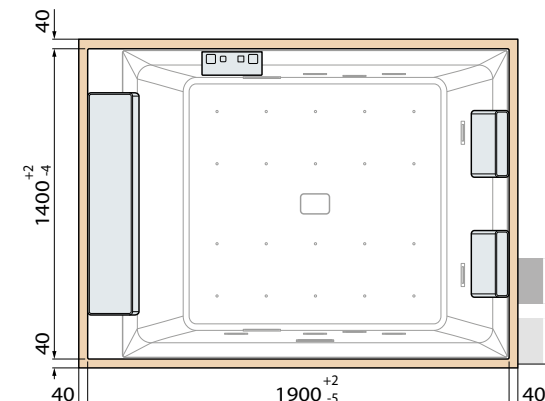
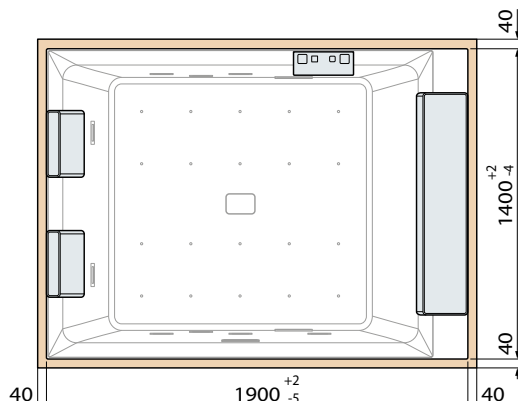

Capacità litri

650

## CARATTERISTICHE IDRAULICHE

20 bocchette airpool  
8 bocchette whirlpool  
2 bocchette Natural Air  
Lama d'acqua a cascata  
Allaccio sifone con raccordo 1 1/2"

## CARATTERISTICHE ELETTRICHE

Tensione 220-230 V  
Frequenza 50 Hz  
Potenza massima assorbita: 2350 W  
Hydro: 900+900 W  
Airpool: 400 W  
Natural Air: 1050 W  
Riscaldatore: 1300 W  
Cascata: 550 W

## CARATTERISTICHE MECCANICHE

Area totale 2.66 m<sup>2</sup>  
Massa vasca+componenti 150 kg  
Massa acqua max 650 kg  
Massa utilizzatori (2 pers.) 75+75 kg  
Massa specifica 400 kg/m<sup>2</sup>

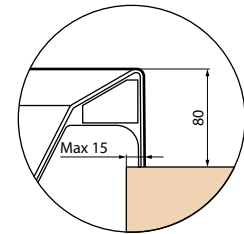
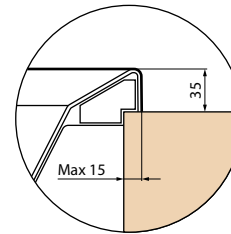
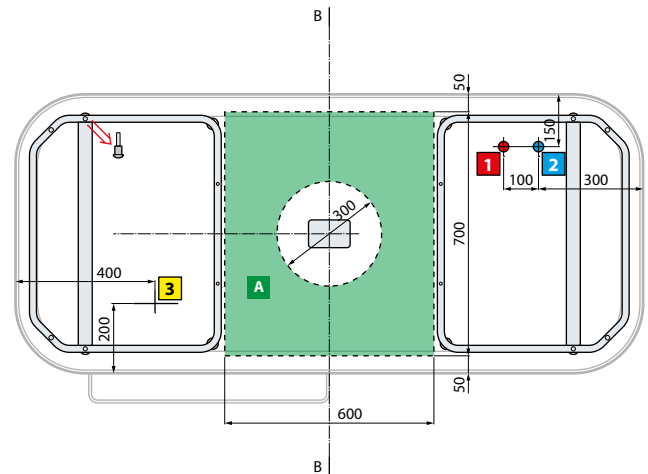
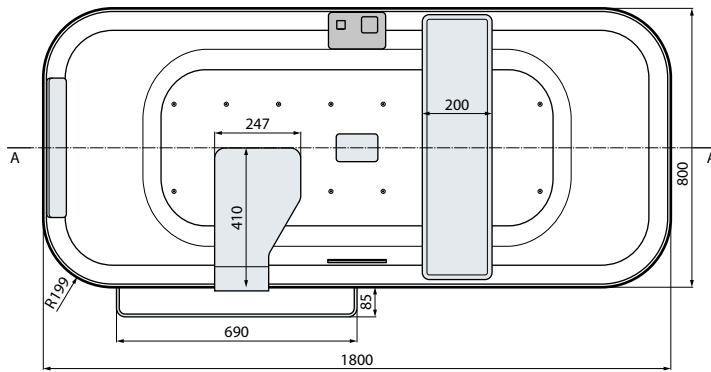
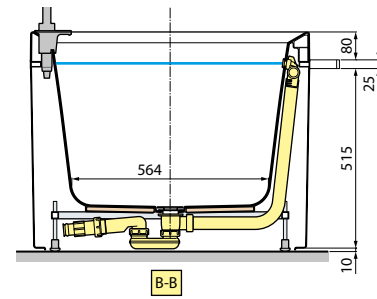
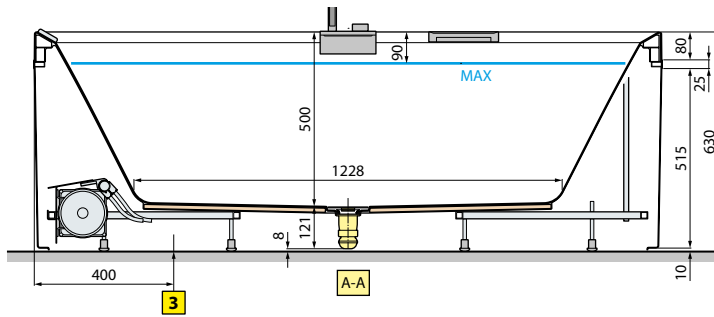

SOLO PER VERSIONE INCASSO

Capacità litri  
300

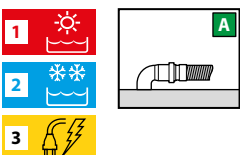

**CARATTERISTICHE IDRAULICHE**  
16 bocchette airpool  
Allaccio sifone con raccordo 1 1/2"

**CARATTERISTICHE ELETTRICHE**  
Tensione 220-230 V  
Frequenza 50 Hz  
Potenza massima assorbita:  
Airpool 400 W

Installare a monte dell'apparecchio un interruttore differenziale da 30mA provvisto di interruttore onnipolare con apertura minima dei contatti  $\geq 3$  mm.

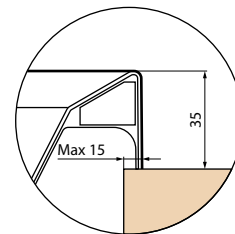
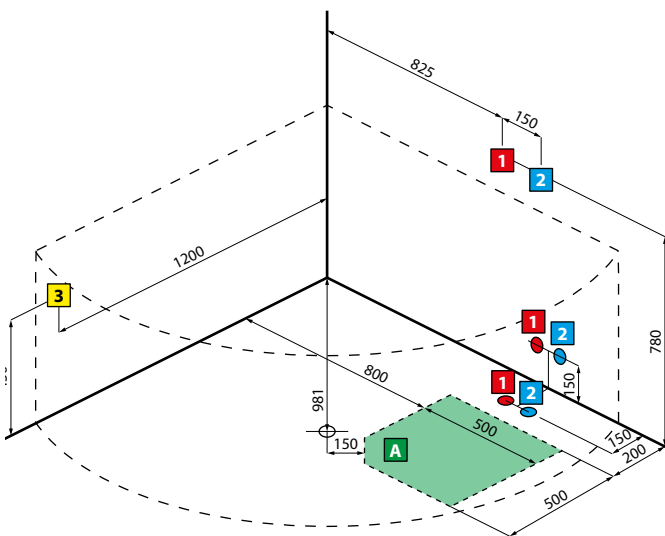
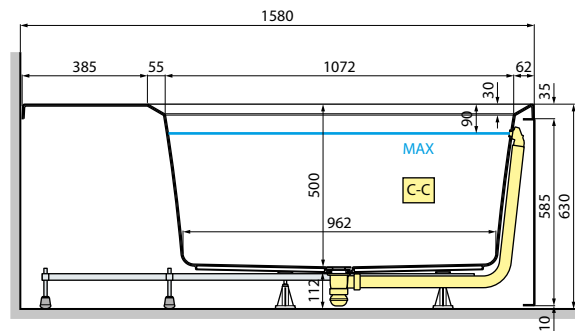
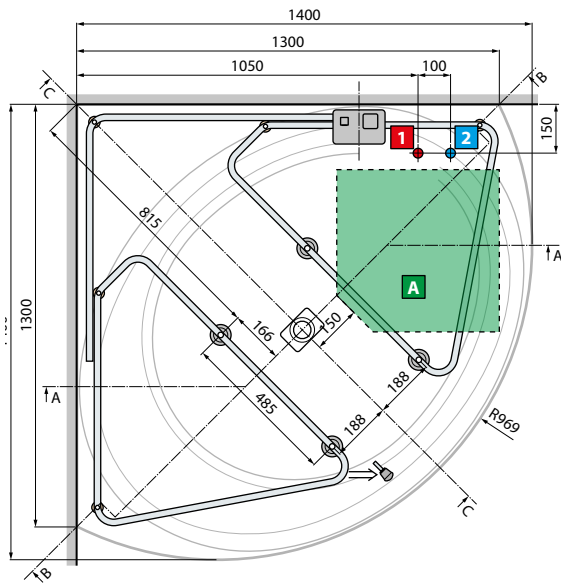
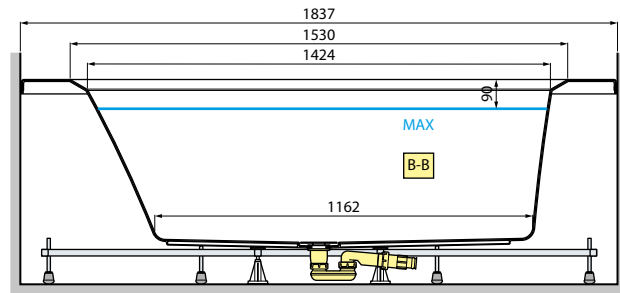
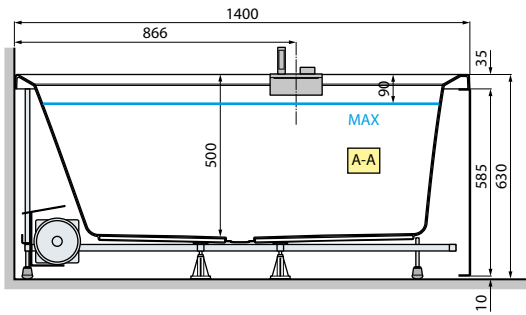

Capacità litri

400

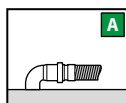

**CARATTERISTICHE IDRAULICHE**  
16 bocchette airpool  
Allaccio sifone con raccordo 1 1/2"

**CARATTERISTICHE ELETTRICHE**  
Tensione 220-230 V  
Frequenza 50 Hz  
Potenza massima assorbita:  
Whirlpool: 900 W  
Airpool: 400 W  
Plus: 1300 W  
Natural Air: 1050 W

Installare a monte dell'apparecchio un interruttore differenziale da 30mA provvisto di interruttore onnipolare con apertura minima dei contatti  $\geq 3$  mm.

VERSIONE SINISTRA

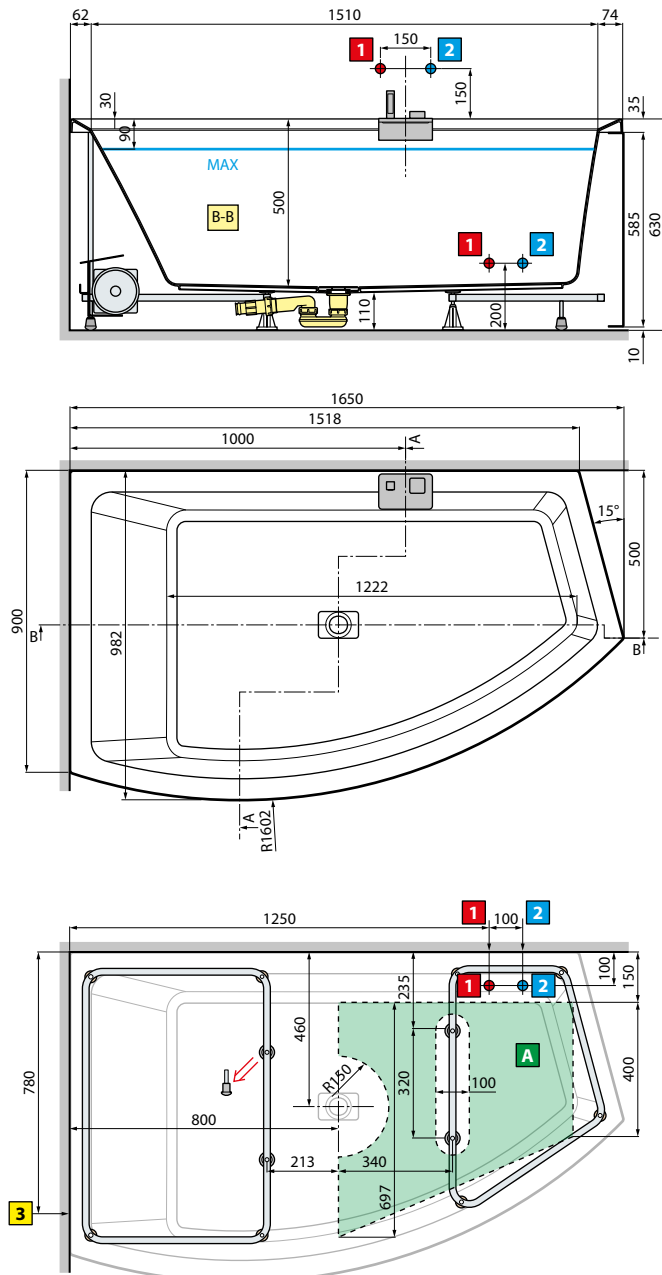

VERSIONE DESTRA

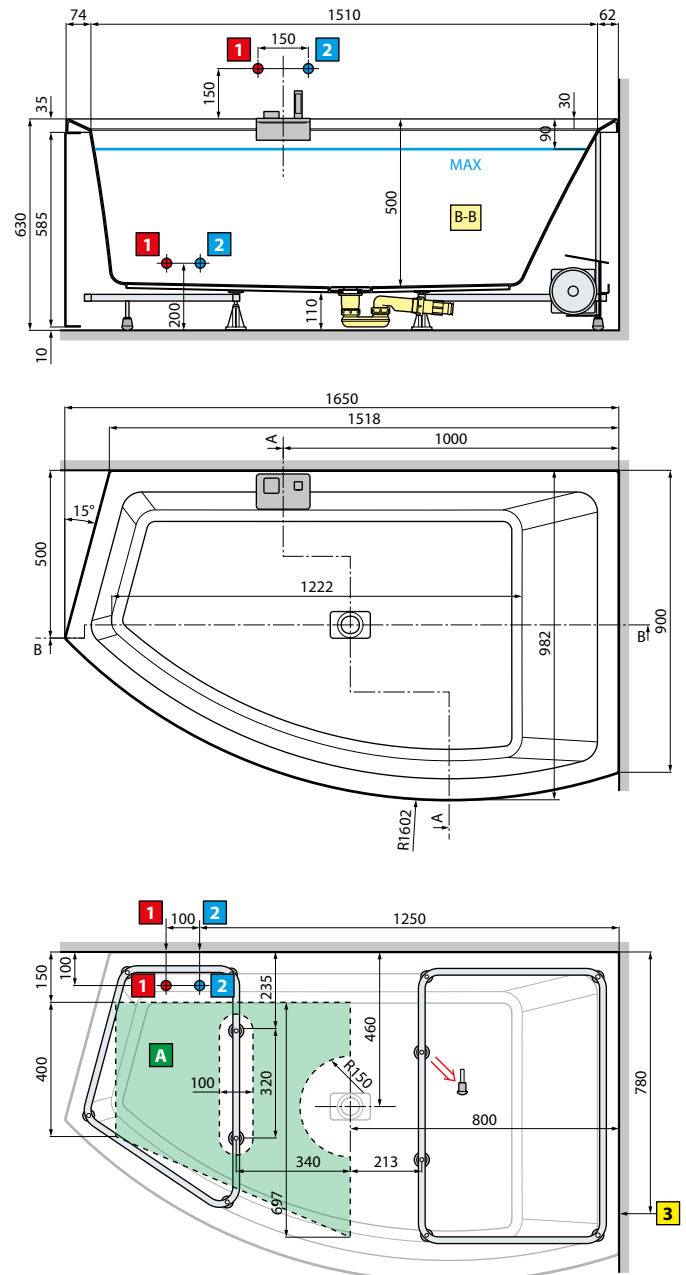

Capacità litri

360

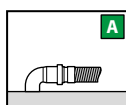
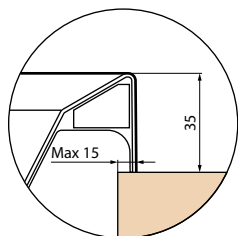

**CARATTERISTICHE IDRAULICHE**  
 16 bocchette airpool  
 Allaccio sifone con raccordo 1 1/2"

**CARATTERISTICHE ELETTRICHE**  
 Tensione 220-230 V  
 Frequenza 50 Hz  
 Potenza massima assorbita:  
 Whirlpool: 900 W  
 Airpool: 400 W  
 Plus: 1300 W  
 Natural Air: 1050 W

Installare a monte dell'apparecchio un interruttore differenziale da 30mA provvisto di interruttore onnipolare con apertura minima dei contatti  $\geq 3$  mm.

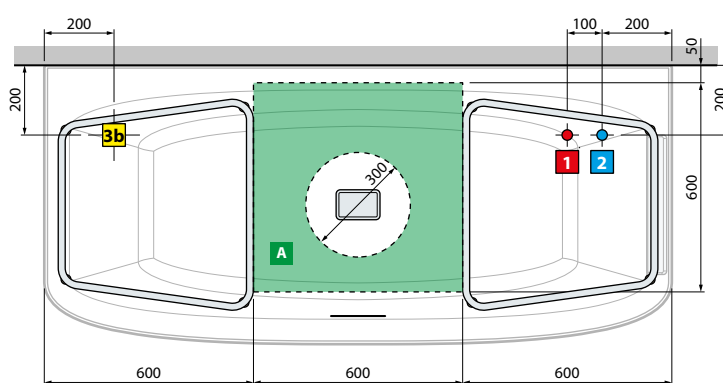
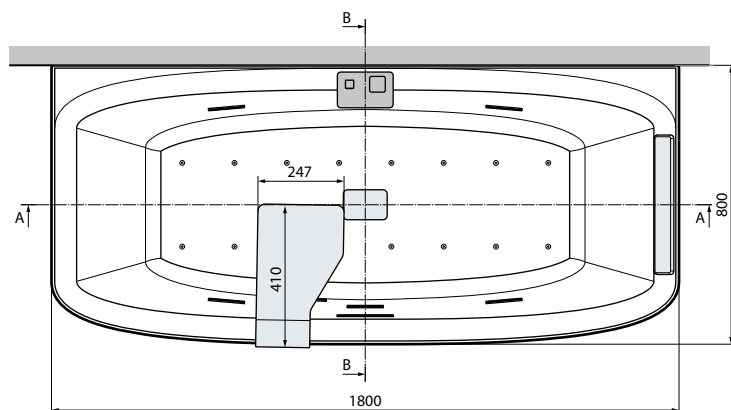
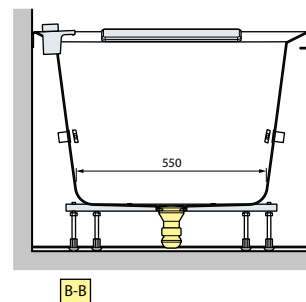
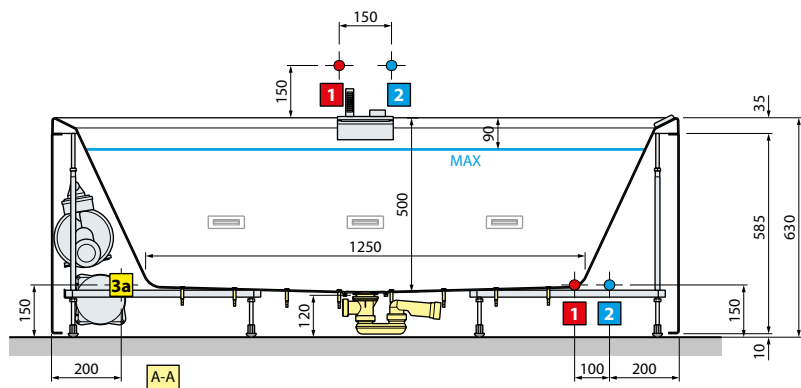

VERSIONE SINISTRA

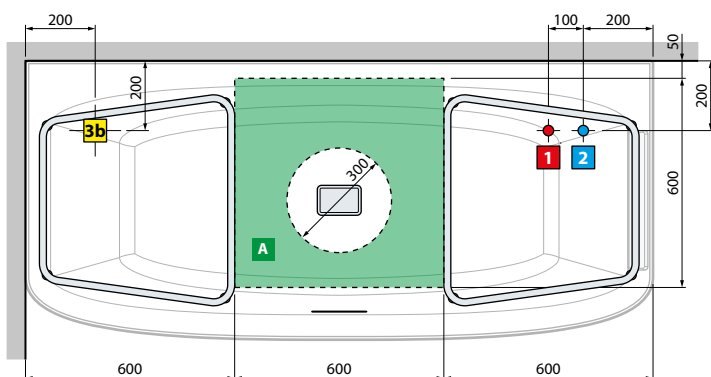

VERSIONE DESTRA

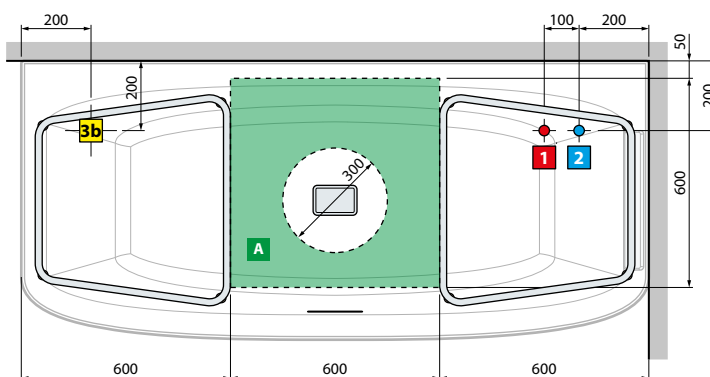

Capacità litri

320

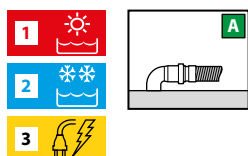

**CARATTERISTICHE IDRAULICHE**

16 bocchette airpool  
6 bocchette whirlpool  
Allaccio sifone con raccordo 1 1/2"

**CARATTERISTICHE ELETTRICHE**

Tensione 220-230 V  
Frequenza 50 Hz  
Potenza massima assorbita:  
Whirlpool: 900 W  
Airpool: 400 W  
Plus: 1300 W  
Natural Air: 1050 W

Installare a monte dell'apparecchio un interruttore differenziale da 30mA provvisto di interruttore onnipolare con apertura minima dei contatti ≥ 3 mm.





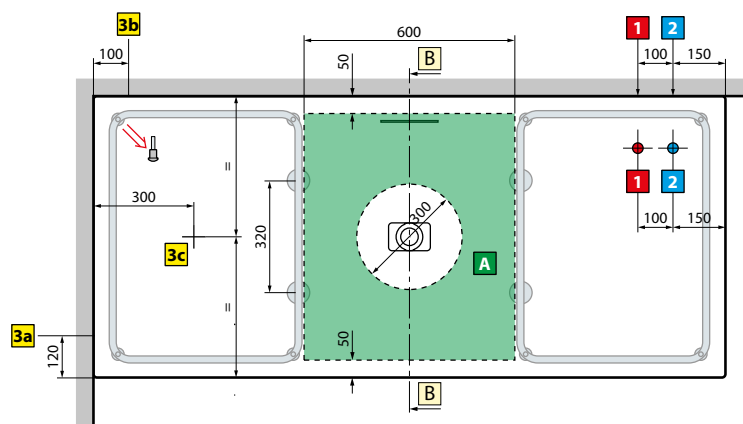
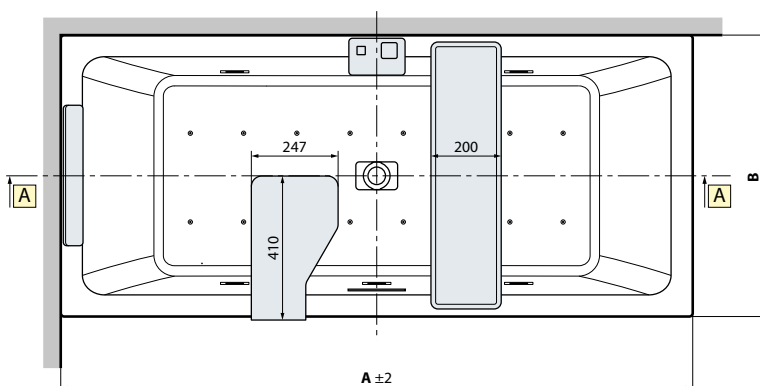
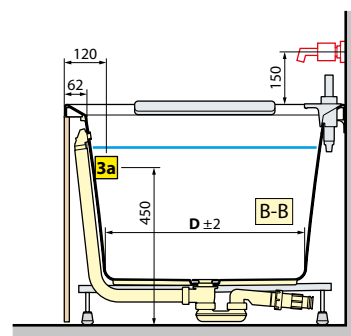
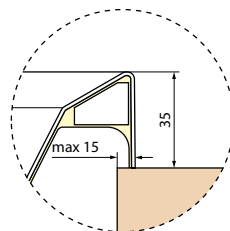
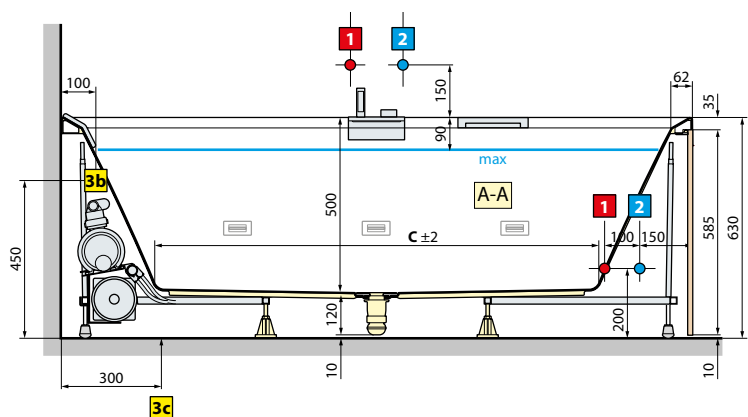

modello	A	B	C	D	Capacità litri
<b>160x70</b>	1600	700	1050	460	250
<b>170x70</b>	1700	700	1150	460	280
<b>170x75</b>	1700	750	1150	510	300
<b>180x80</b>	1800	800	1250	560	350
<b>180x100</b>	1800	1000	1250	760	430
<b>190x90</b>	1900	900	1350	660	420

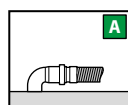

**CARATTERISTICHE IDRAULICHE**  
 16 bocchette airpool  
 6 bocchette whirlpool  
 Allaccio sifone con raccordo 1 1/2"

**CARATTERISTICHE ELETTRICHE**  
 Tensione 220-230 V  
 Frequenza 50 Hz  
 Potenza massima assorbita:  
 Whirlpool: 900 W  
 Airpool: 400 W  
 Plus: 1300 W  
 Natural Air: 1050 W

Installare a monte dell'apparecchio un interruttore differenziale da 30mA provvisto di interruttore onnipolare con apertura minima dei contatti ≥ 3 mm.

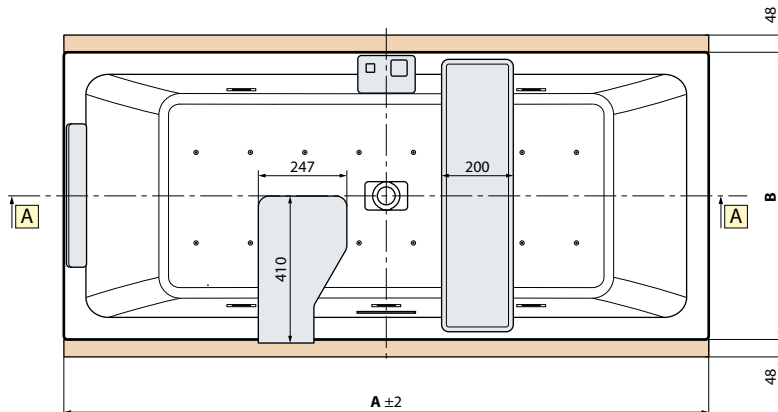
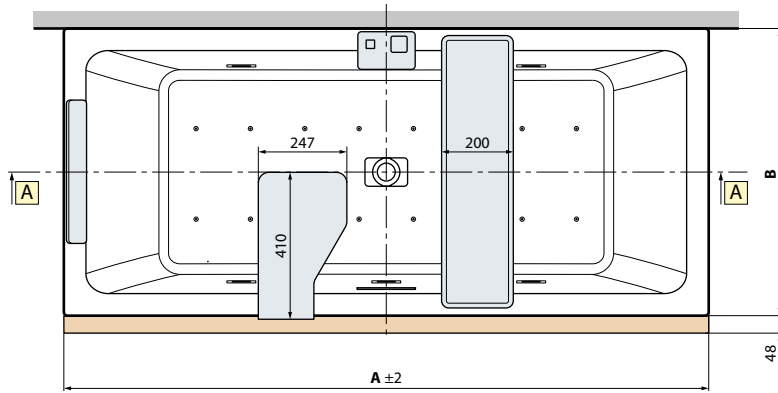
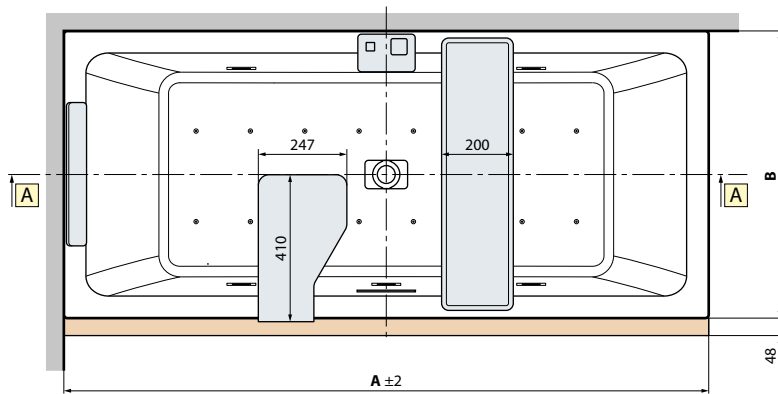
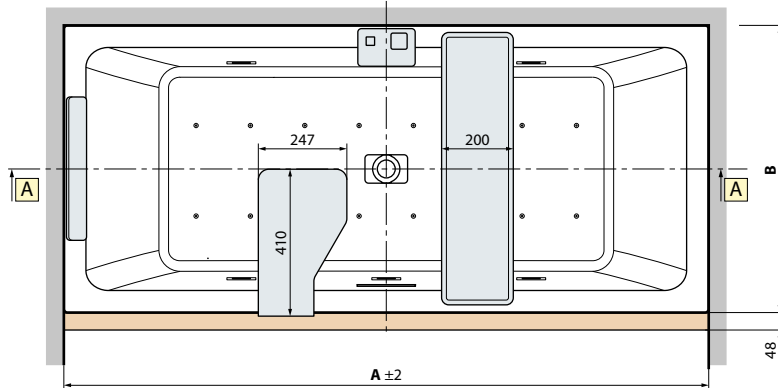
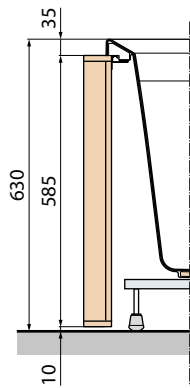
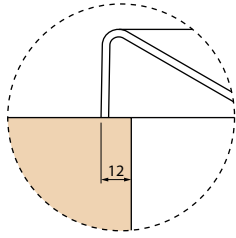

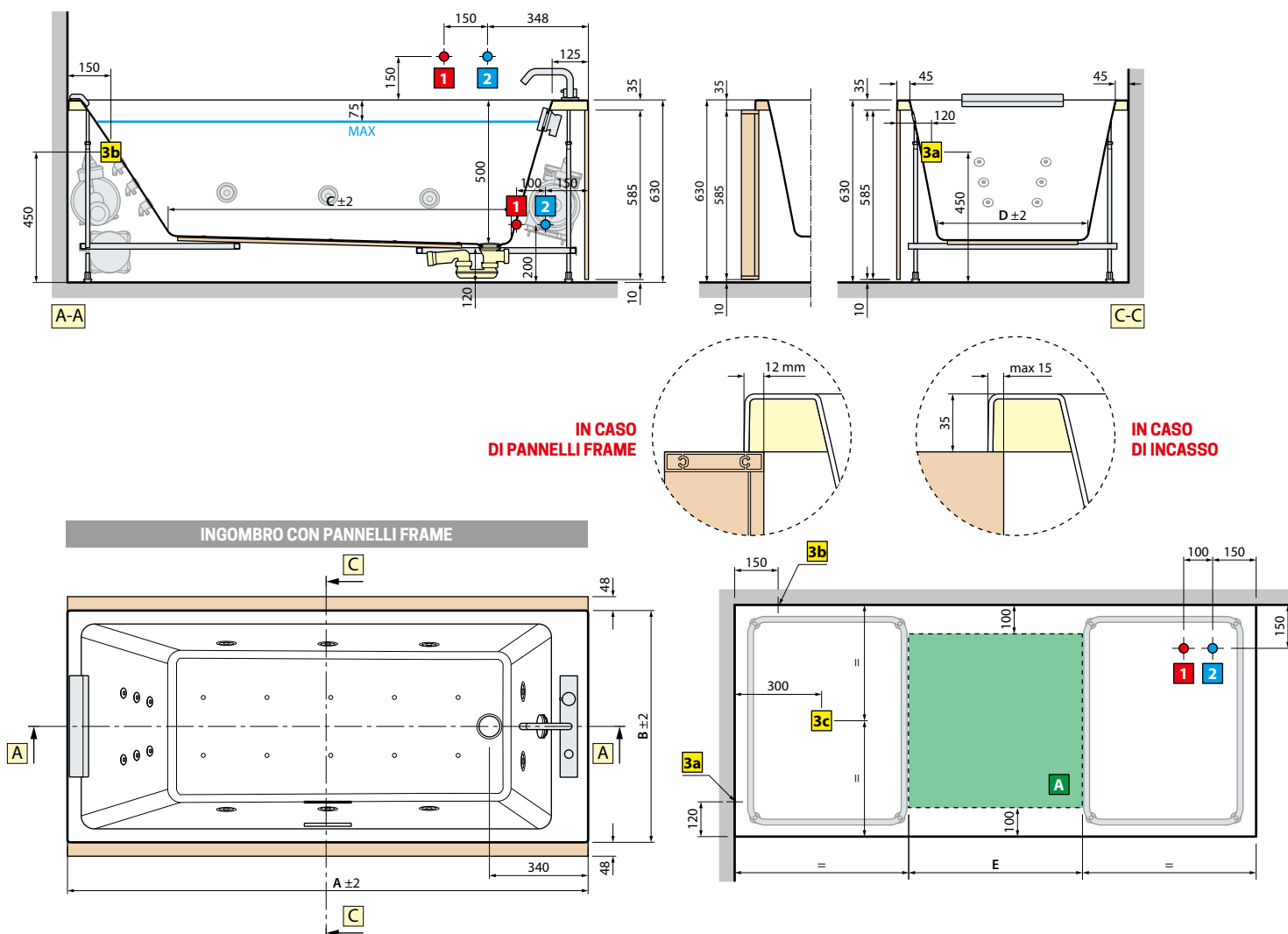

modello	A	B	C	D	E	Capacità litri
<b>170x70</b>	1700	700	1080	420	500	250
<b>170x75</b>	1700	750	1080	470	500	280
<b>180x80</b>	1800	800	1180	520	600	330
<b>180x110</b>	1800	1100	1180	820	600	500
<b>190x90</b>	1900	900	1280	620	600	410

**POTENZE ELETTRICHE**

	HYDRO AIR	WHIRLPOOL	HYDRO PLUS	NATURAL AIR	WHIRLPOOL+ NATURAL AIR
riscaldatore	—	—	—	—	—
whirlpool	—	550 W	900 W	—	550 W
airpool	400 W	—	400 W	—	—
natural air	—	—	—	1.050 W	1.050 W
<b>TOTALE</b>	<b>400 W</b>	<b>550 W</b>	<b>1.300 W</b>	<b>1.050 W</b>	<b>1.050 W</b>

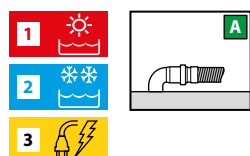

Installare a monte dell'apparecchio un interruttore differenziale da 30mA provvisto di interruttore onnipolare con apertura minima dei contatti  $\geq 3$  mm.

**CARATTERISTICHE IDRAULICHE**  
Allaccio sifone con raccordo 1 1/2"

**CARATTERISTICHE ELETTRICHE**  
Tensione 220-230 V  
Frequenza 50 Hz

DISEGNI TECNICI

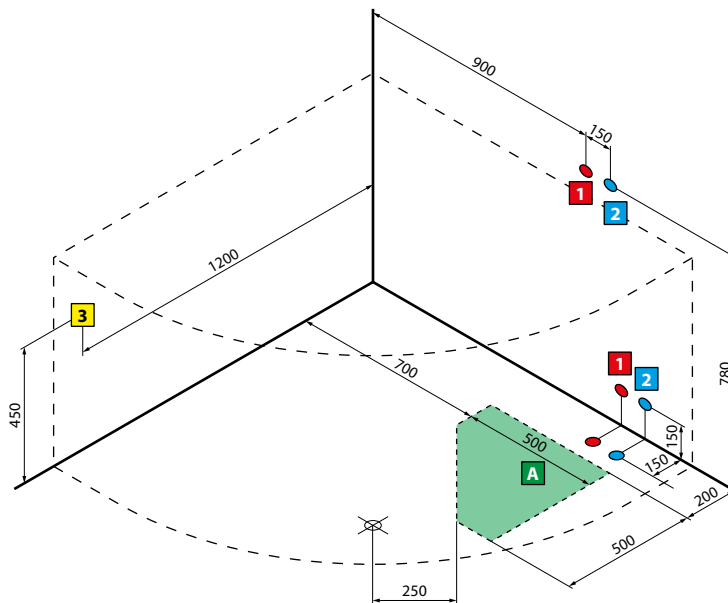
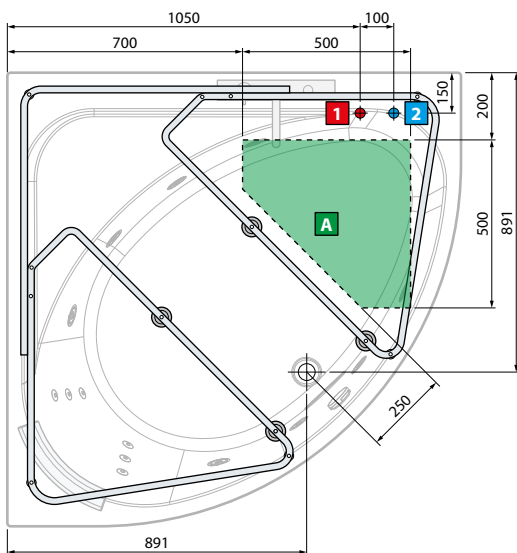
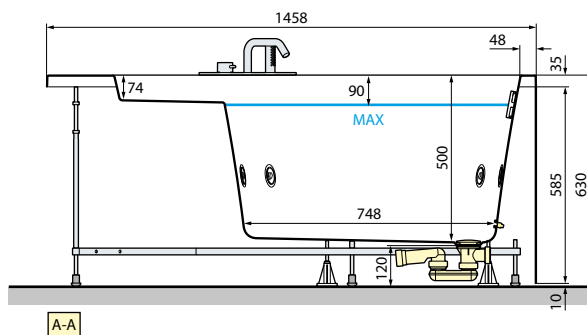
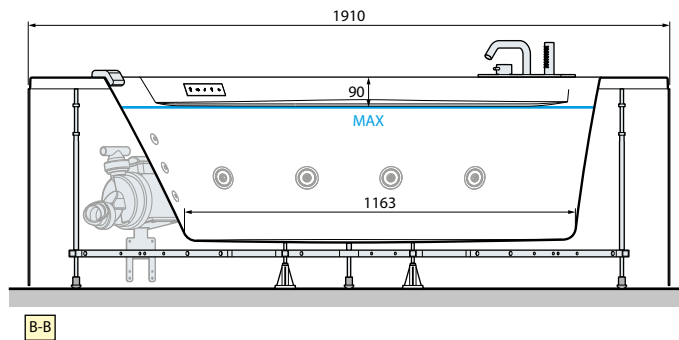
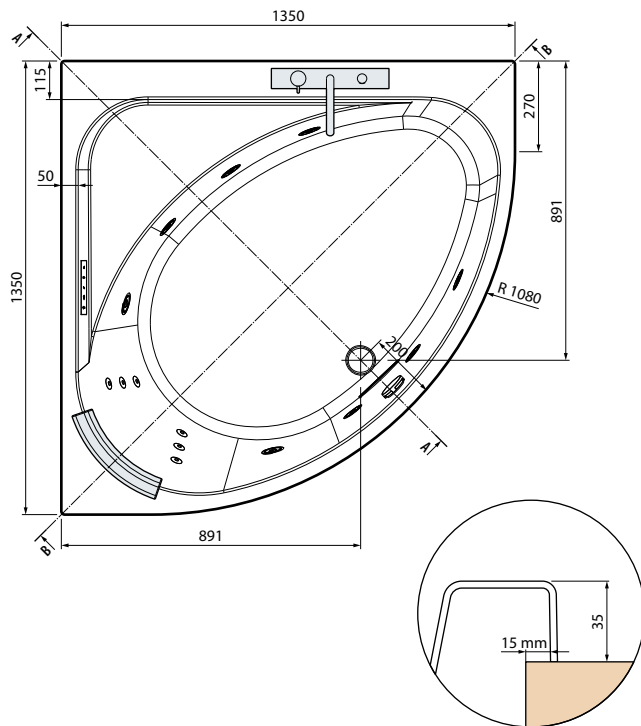

POTENZE ELETTRICHE

	HYDRO AIR	WHIRLPOOL	HYDRO PLUS	NATURAL AIR	WHIRLPOOL+NATURAL AIR
riscaldatore	—	—	—	—	—
whirlpool	—	550 W	900 W	—	550 W
airpool	400 W	—	400 W	—	—
natural air	—	—	—	1.050 W	1.050 W
<b>TOTALE</b>	<b>400 W</b>	<b>550 W</b>	<b>1.300 W</b>	<b>1.050 W</b>	<b>1.050 W</b>

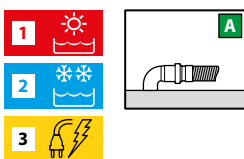

Installare a monte dell'apparecchio un interruttore differenziale da 30mA provvisto di interruttore onnipolare con apertura minima dei contatti ≥ 3 mm.

**CARATTERISTICHE IDRAULICHE**  
Allaccio sifone con raccordo 1 1/2"

**CARATTERISTICHE ELETTRICHE**  
Tensione 220-230 V  
Frequenza 50 Hz

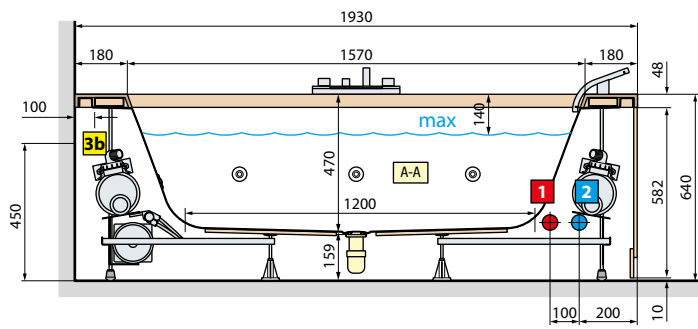

Particolare vasca ad incasso

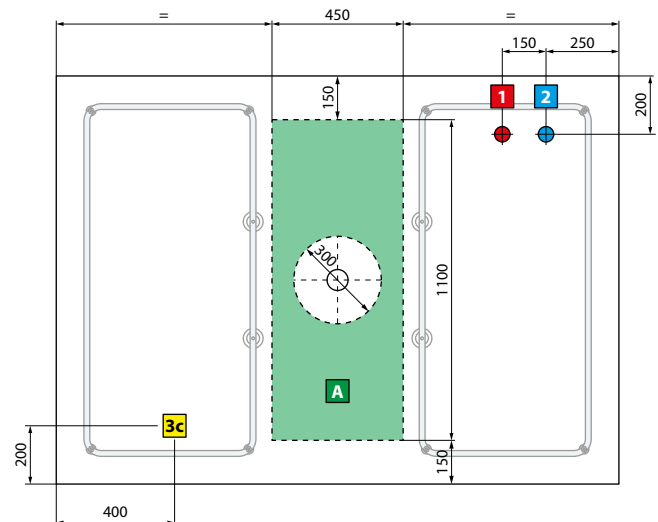
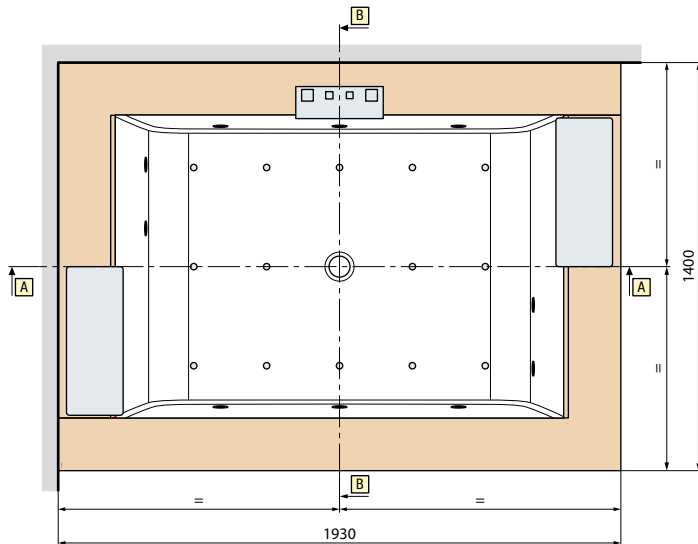
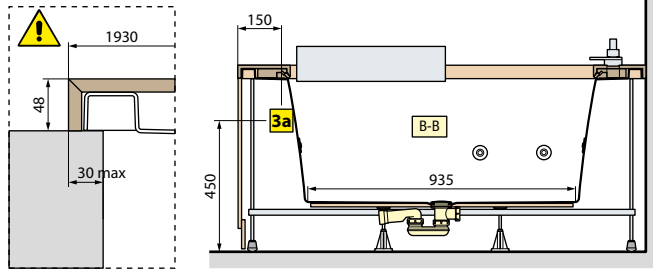

Capacità litri

450

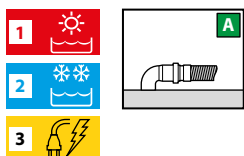

**ATTENZIONE!**  
Può essere dannoso ai portatori di pacemakers

Installare a monte dell'apparecchio un interruttore differenziale da 30mA provvisto di interruttore onnipolare con apertura minima dei contatti  $\geq 3$  mm.

### CARATTERISTICHE IDRAULICHE

10 bocchette whirlpool  
14 bocchette airpool  
Allaccio sifone con raccordo 1 1/2"

### CARATTERISTICHE ELETTRICHE

Tensione 220-230 V  
Frequenza 50 Hz  
Potenza massima assorbita: 2950 W  
Riscaldatore: 1450 W  
Whirlpool: 550+550 W  
Airpool: 400 W

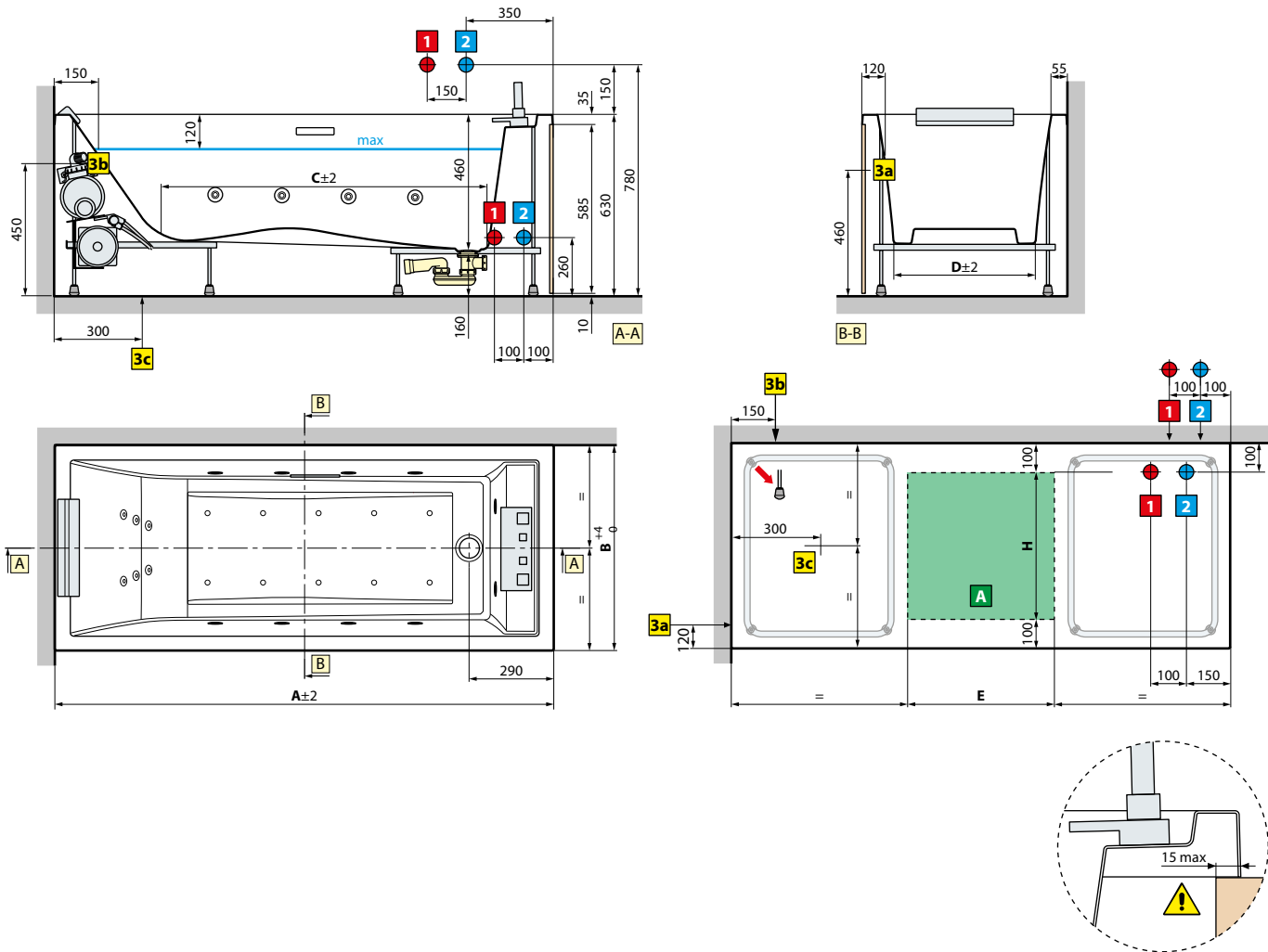

modello	A	B	C	D	E	Capacità litri
<b>170x70</b>	1700	700	1107	475	500	205
<b>170x75</b>	1700	750	1107	525	500	225
<b>180x80</b>	1800	800	1142	575	600	250
<b>190x80</b>	1900	800	1173	575	700	265

POTENZE ELETTRICHE

	HYDRO AIR	WHIRLPOOL + DISINFEZIONE	WHIRLPOOL DISINFEZIONE + LIGHT	HYDRO PLUS	WHIRLPOOL + NATURAL AIR
riscaldatore	—	—	—	1.300 W	—
whirlpool	—	550 W	550 W	900 W	550 W
airpool	400 W	—	—	400 W	—
natural air	—	—	—	—	1.050 W
<b>TOTALE</b>	<b>400 W</b>	<b>550 W</b>	<b>550 W</b>	<b>2.600 W</b>	<b>1.050 W</b>

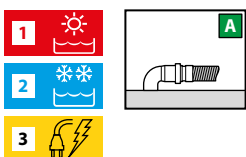

Installare a monte dell'apparecchio un interruttore differenziale da 30mA provvisto di interruttore onnipolare con apertura minima dei contatti > 3mm.

**CARATTERISTICHE IDRAULICHE**  
Allaccio sifone con raccordo 1 1/2"

**CARATTERISTICHE ELETTRICHE**  
Tensione 220-230 V  
Frequenza 50 Hz



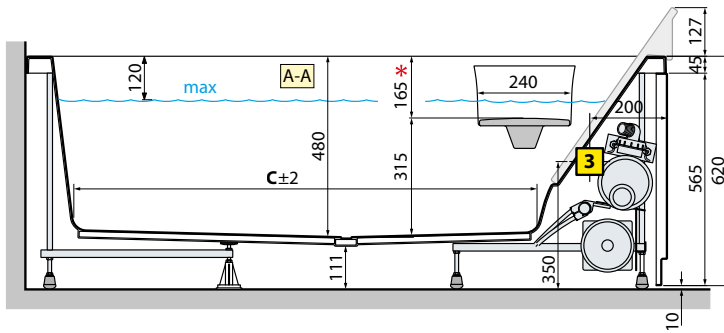

\* 145 mm per il mod. 160x70/80

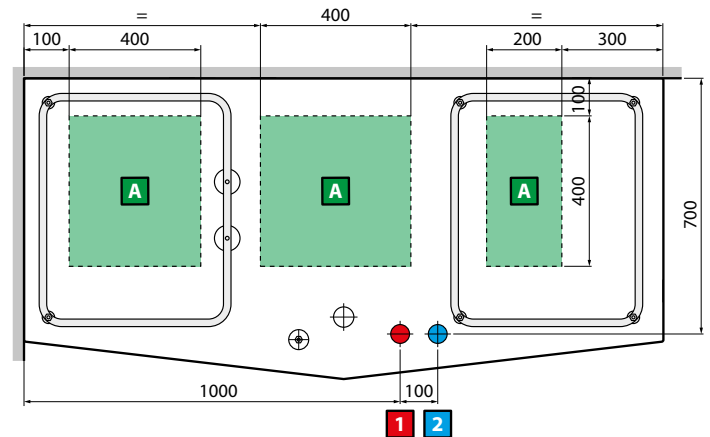
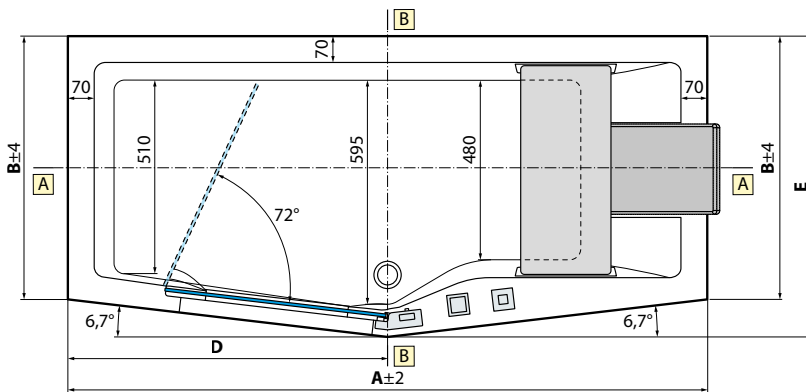
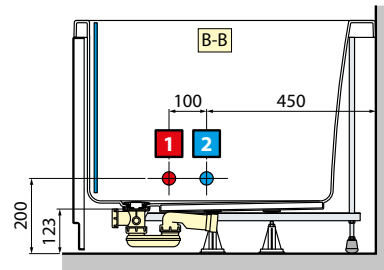
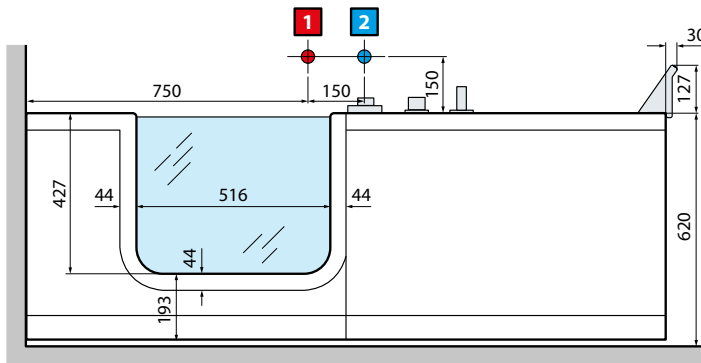

modello	A	B	C	D	E	Capacità litri
<b>160x70/80</b>	1600	700	1140	860	800	250
<b>170x70/80</b>	1700	700	1235	850	800	265
<b>180x75/85</b>	1800	750	1345	860	850	305

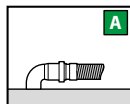
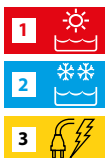

**ATTENZIONE!**  
Può essere dannoso ai portatori di pacemakers

Installare a monte dell'apparecchio un interruttore differenziale da 30mA provvisto di interruttore onnipolare con apertura minima dei contatti  $\geq 3$  mm.

### CARATTERISTICHE IDRAULICHE

6 bocchette whirlpool  
16 bocchette airpool  
Allaccio sifone con raccordo 1 1/2"

### CARATTERISTICHE ELETTRICHE

Tensione 220-230 V  
Frequenza 50 Hz  
Potenza massima assorbita: 950 W  
Whirlpool: 550 W  
Airpool: 400 W



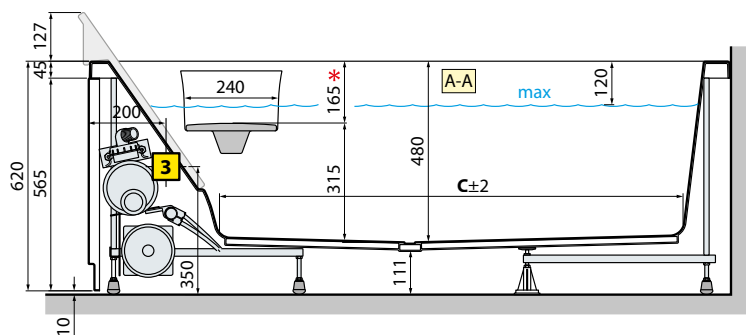

\* 145 mm per il mod. 160x70/80

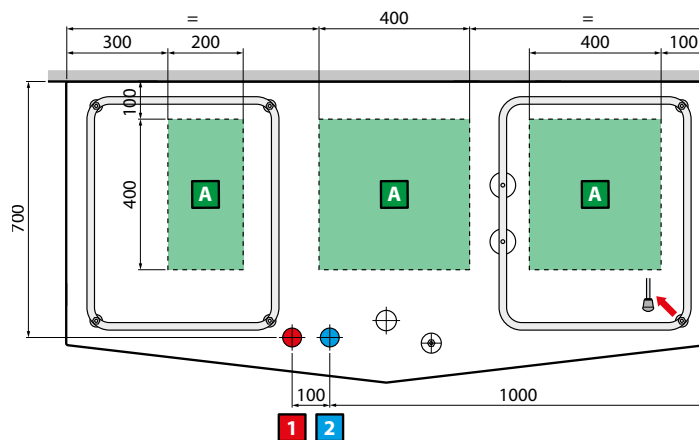
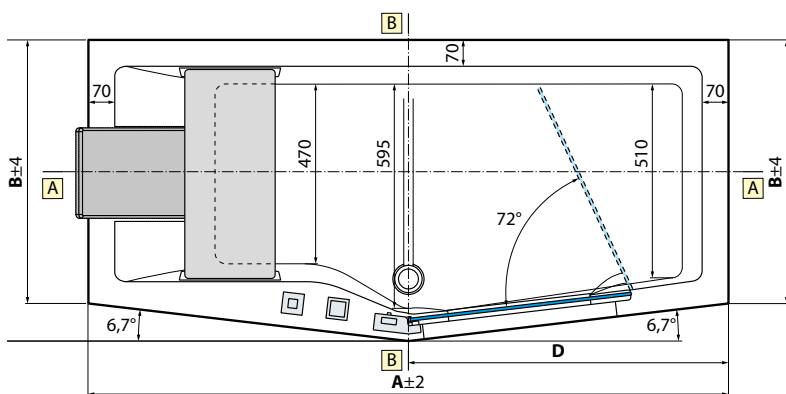
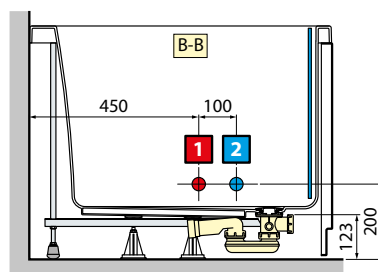
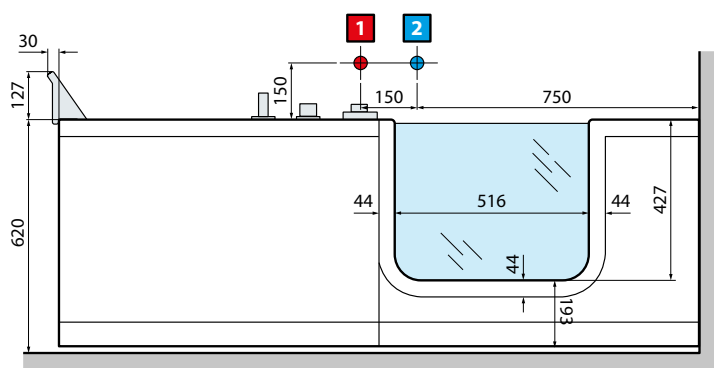

modello	A	B	C	D	E	Capacità litri
<b>160x70/80</b>	1600	700	1140	860	800	250
<b>170x70/80</b>	1700	700	1235	850	800	265
<b>180x75/85</b>	1800	750	1345	860	850	305

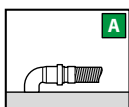

**ATTENZIONE!**  
Può essere dannoso ai portatori di pacemakers

Installare a monte dell'apparecchio un interruttore differenziale da 30mA provvisto di interruttore onnipolare con apertura minima dei contatti  $\geq 3$  mm.

### CARATTERISTICHE IDRAULICHE

6 bocchette whirlpool  
16 bocchette airpool  
Allaccio sifone con raccordo 1 1/2"

### CARATTERISTICHE ELETTRICHE

Tensione 220-230 V  
Frequenza 50 Hz  
Potenza massima assorbita: 950 W  
Whirlpool: 550 W  
Airpool: 400 W

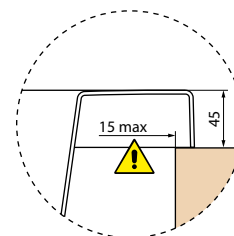
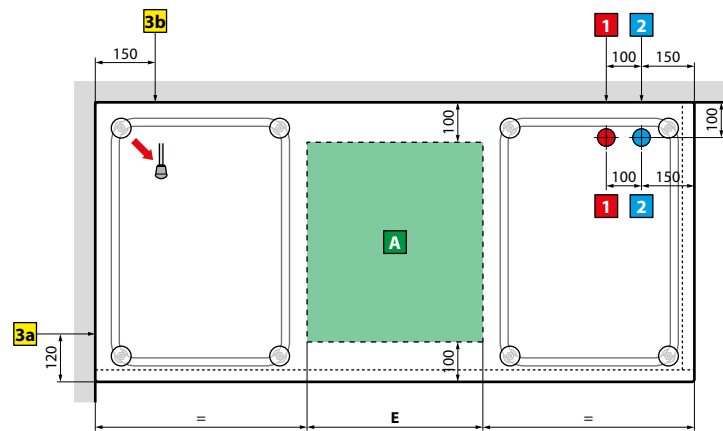
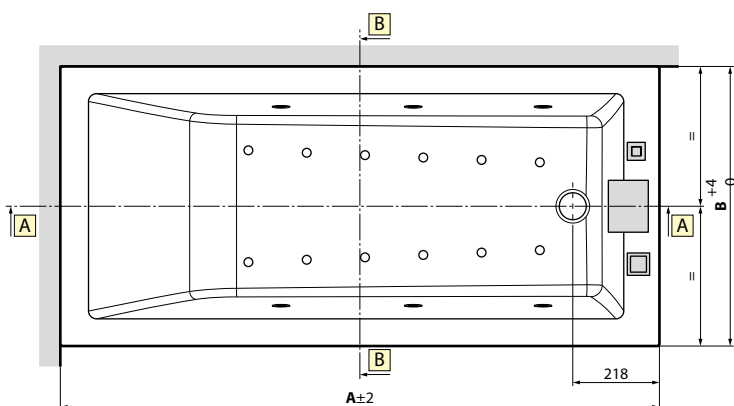
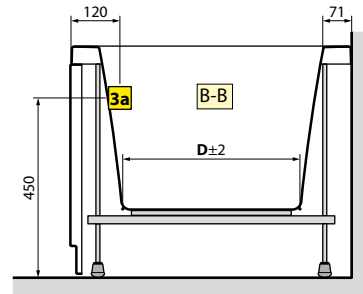
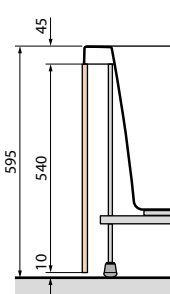
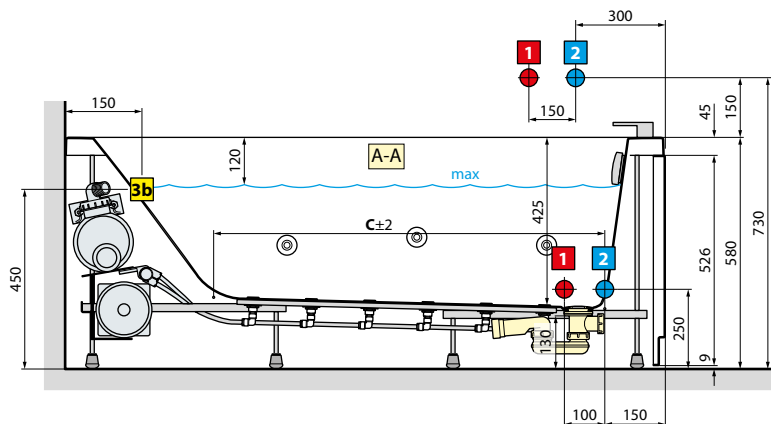

Modello	A	B	C	D	E	Capacità litri
<b>150x70</b>	1500	700	979	444	300	155
<b>160x70</b>	1600	700	1081	444	400	170
<b>170x70</b>	1700	700	1183	444	500	185
<b>170x75</b>	1700	750	1183	494	500	200
<b>170x80</b>	1700	800	1183	544	500	215
<b>180x80</b>	1800	800	1285	544	600	235

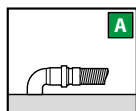
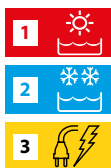

**ATTENZIONE!**  
Può essere dannoso ai portatori di pacemakers

Installare a monte dell'apparecchio un interruttore differenziale da 30mA provvisto di interruttore onnipolare con apertura minima dei contatti  $\geq 3$ mm.

**CARATTERISTICHE IDRAULICHE**  
6 bocchette whirlpool  
12 bocchette airpool  
Allaccio sifone con raccordo 1 1/2"

**CARATTERISTICHE ELETTRICHE**  
Tensione 220-230 V  
Frequenza 50 Hz  
Potenza massima assorbita: 950 W  
Whirlpool: 550 W  
Airpool: 400 W

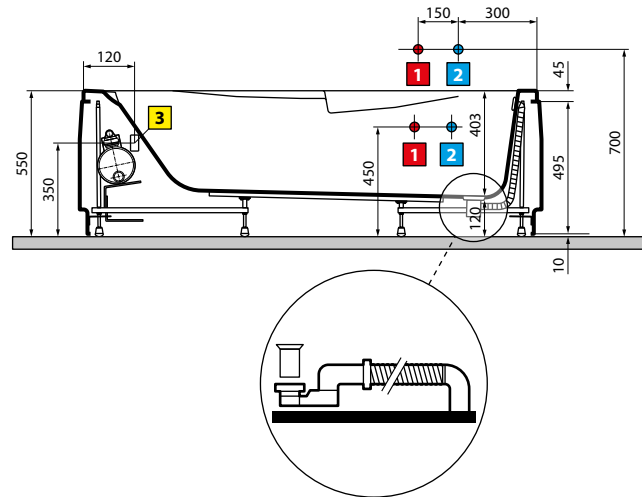
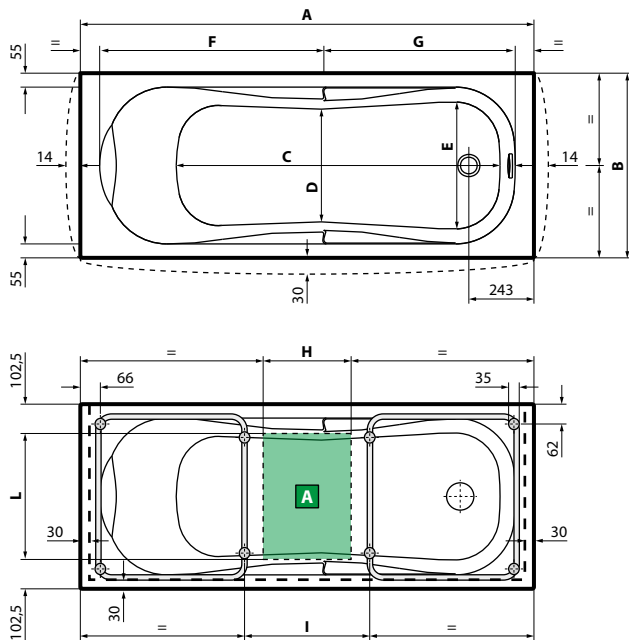

modello	A	B	C	D	E	F	G	H	I	L	Capacità litri
<b>150x70</b>	1495	695	1000	420	470	730	625	290	412,5	490	150
<b>160x70</b>	1595	695	1100	420	470	780	675	390	512	490	160
<b>170x70</b>	1695	695	1200	420	470	830	725	490	611,5	490	170
<b>170x75</b>	1695	745	1200	470	520	830	725	370	491,5	540	180
<b>170x80</b>	1695	795	1200	500	570	830	725	400	535	590	190
<b>180x80</b>	1795	795	1300	500	570	880	775	500	631,5	590	200

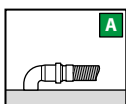

**ATTENZIONE!**  
Può essere dannoso ai portatori di pacemakers

Installare a monte dell'apparecchio un interruttore differenziale da 30mA provvisto di interruttore onnipolare con apertura minima dei contatti  $\geq 3$  mm.

**CARATTERISTICHE IDRAULICHE**  
5/7 bocchette whirlpool  
12 bocchette airpool  
Allaccio sifone con raccordo 1 1/2"

**CARATTERISTICHE ELETTRICHE**  
Tensione 220-230 V  
Frequenza 50 Hz  
Potenza massima assorbita: 950 W  
Whirlpool: 550 W  
Airpool: 400 W

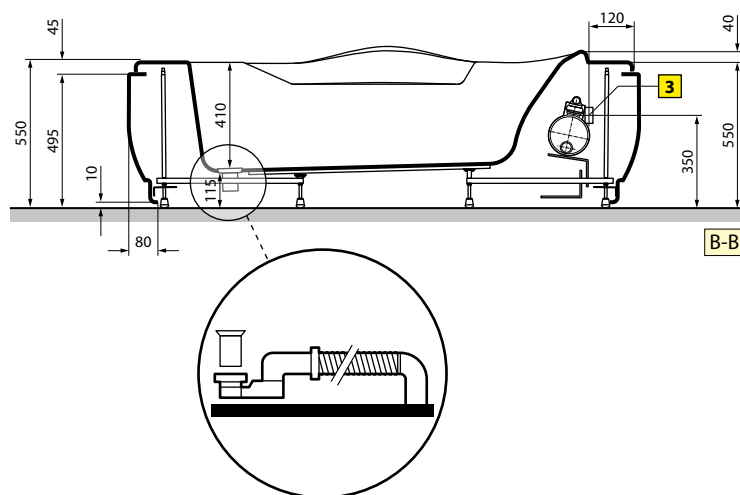
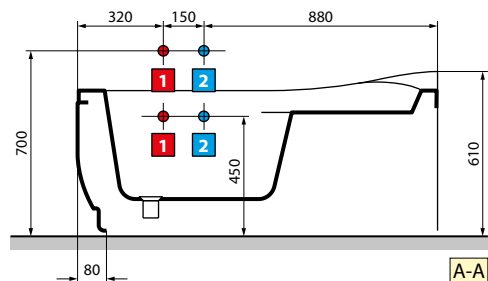
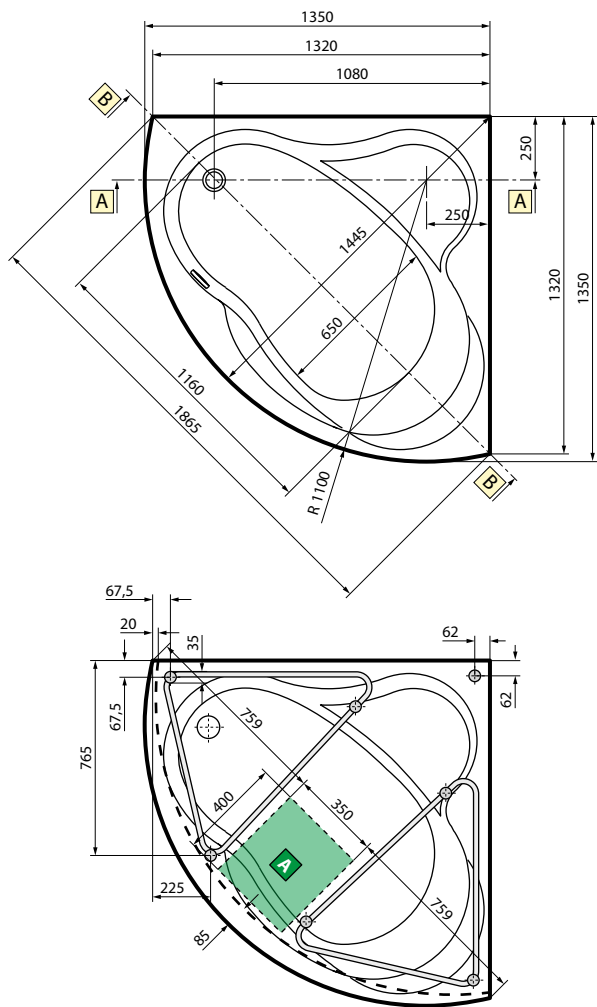

Capacità litri  
190

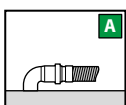

**ATTENZIONE!**  
Può essere dannoso ai portatori di pacemakers

Installare a monte dell'apparecchio un interruttore differenziale da 30mA provvisto di interruttore onnipolare con apertura minima dei contatti  $\geq 3$  mm.

**CARATTERISTICHE IDRAULICHE**  
6 bocchette whirlpool  
12 bocchette airpool  
Allaccio sifone con raccordo 1 1/2"

**CARATTERISTICHE ELETTRICHE**  
Tensione 220-230 V  
Frequenza 50 Hz  
Potenza massima assorbita: 950 W  
Whirlpool: 550 W  
Airpool: 400 W

VERSIONE SINISTRA

VERSIONE DESTRA

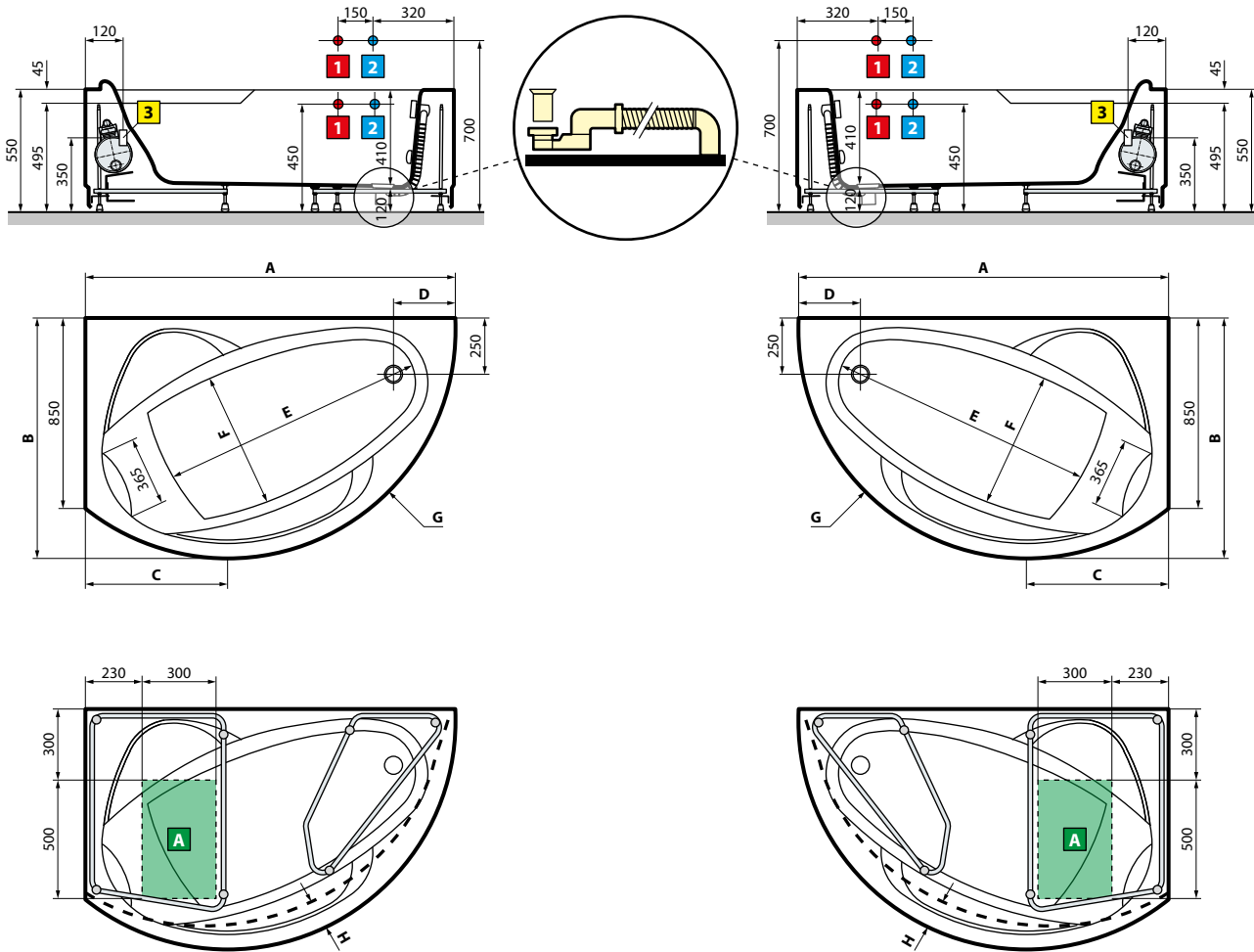

modello	A	B	C	D	E	F	G	H	Capacità litri
<b>150x85</b>	1500	1015	550	290	1030	580	962	137	140
<b>165x85</b>	1650	1070	630	280	1150	640	1015	155	180

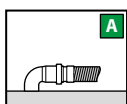

**ATTENZIONE!**  
Può essere dannoso ai portatori di pacemakers

Installare a monte dell'apparecchio un interruttore differenziale da 30mA provvisto di interruttore onnipolare con apertura minima dei contatti  $\geq 3$  mm.

**CARATTERISTICHE IDRAULICHE**

5/7 bocchette whirlpool  
12 bocchette airpool  
Allaccio sifone con raccordo 1 1/2"

**CARATTERISTICHE ELETTRICHE**

Tensione 220-230 V  
Frequenza 50 Hz  
Potenza massima assorbita: 950 W  
Whirlpool: 550 W  
Airpool: 400 W

VERSIONE SINISTRA

VERSIONE DESTRA

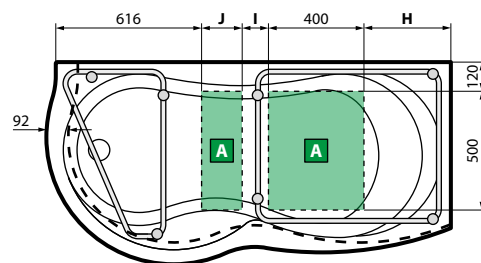
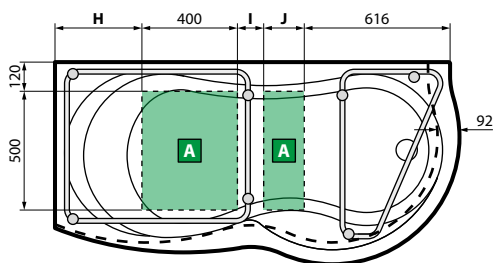
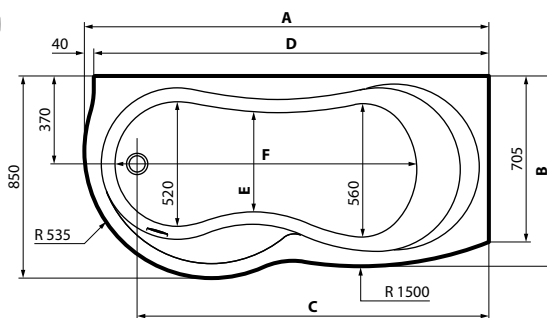
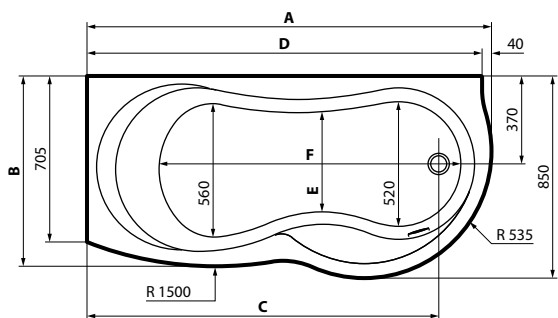
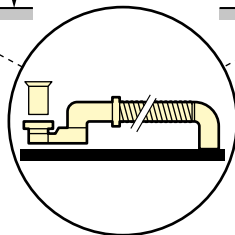
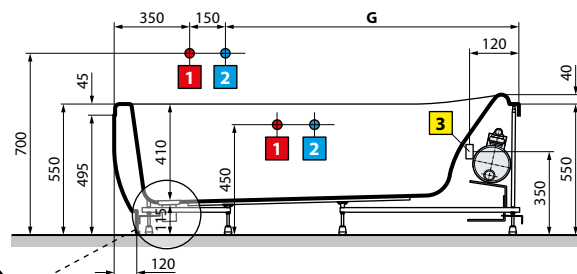
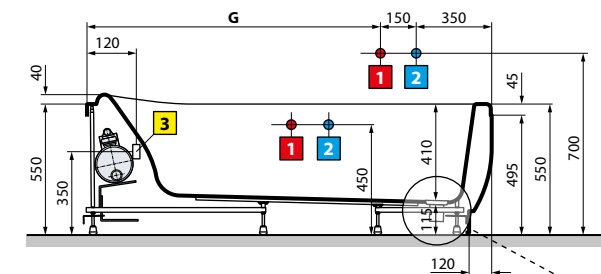

modello	A	B	C	D	E	F	G	H	I	J	Capacità litri
<b>170x85</b>	1700	800	1475	1660	420	1260	1200	364	110	170	190
<b>180x85</b>	1800	815	1575	1760	440	1360	1300	354	140	250	200

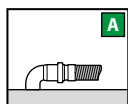

**ATTENZIONE!**  
Può essere dannoso ai portatori di pacemakers

Installare a monte dell'apparecchio un interruttore differenziale da 30mA provvisto di interruttore onnipolare con apertura minima dei contatti  $\geq 3$  mm.

**CARATTERISTICHE IDRAULICHE**

6 bocchette whirlpool  
16 bocchette airpool  
Allaccio sifone con raccordo 1 1/2"

**CARATTERISTICHE ELETTRICHE**

Tensione 220-230 V  
Frequenza 50 Hz  
Potenza massima assorbita: 950 W  
Whirlpool: 550 W  
Airpool: 400 W

# BABY

# DISEGNI TECNICI

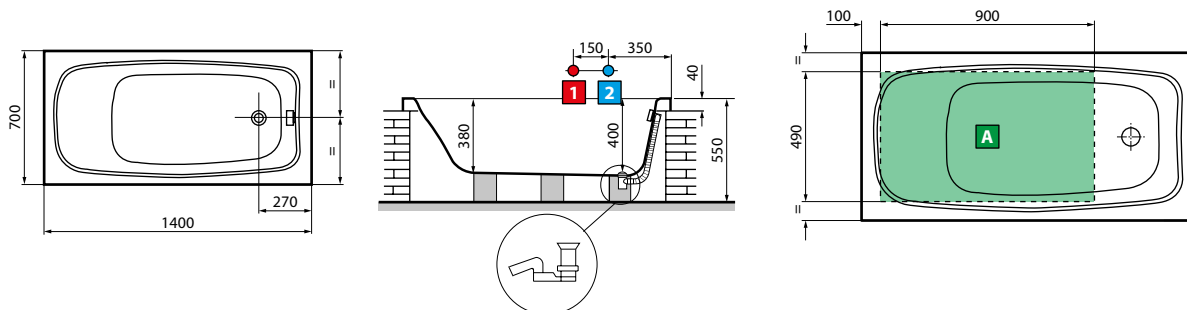

**Capacità litri**  
100

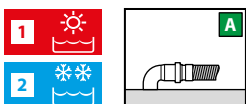

**CARATTERISTICHE IDRAULICHE**  
Allaccio sifone con raccordo 1 1/2"

# BABY TWO

# DISEGNI TECNICI

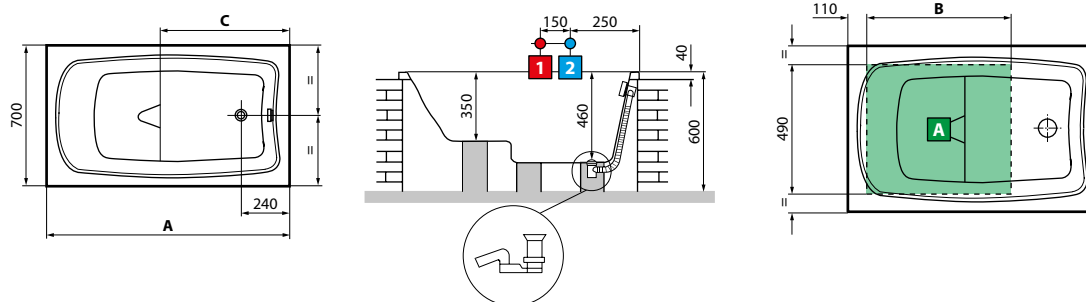

modello	A	B	C	Capacità litri
<b>105x70</b>	1050	570	570	61
<b>120x70</b>	1200	720	640	81



**CARATTERISTICHE IDRAULICHE**  
Allaccio sifone con raccordo 1 1/2"

DISEGNI TECNICI

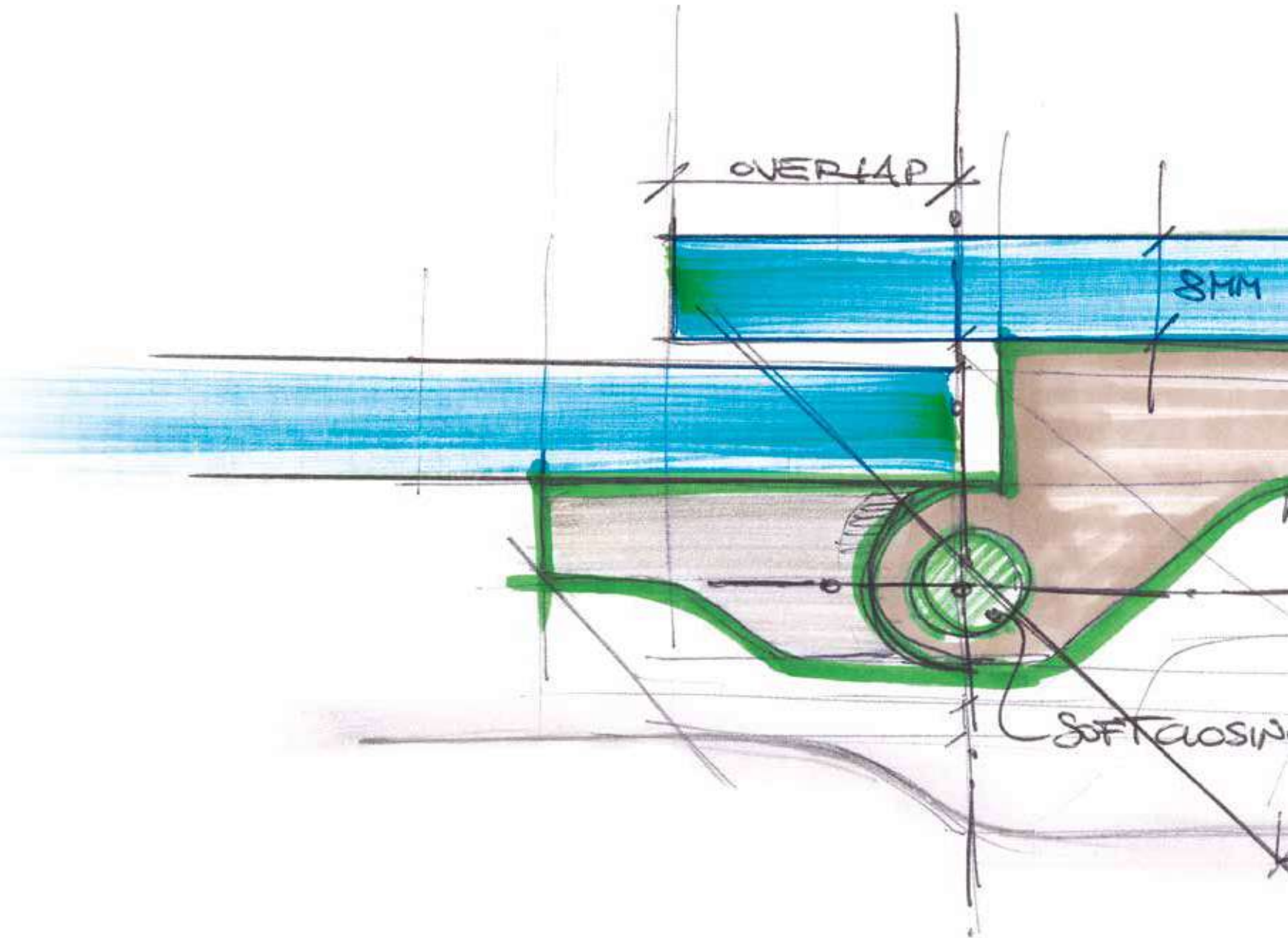

- 584 Gala
- 585 Kuadra
- 586 Young
- 589 Rose Rosse
- 591 Aurora
- 600 Riviera 2.0



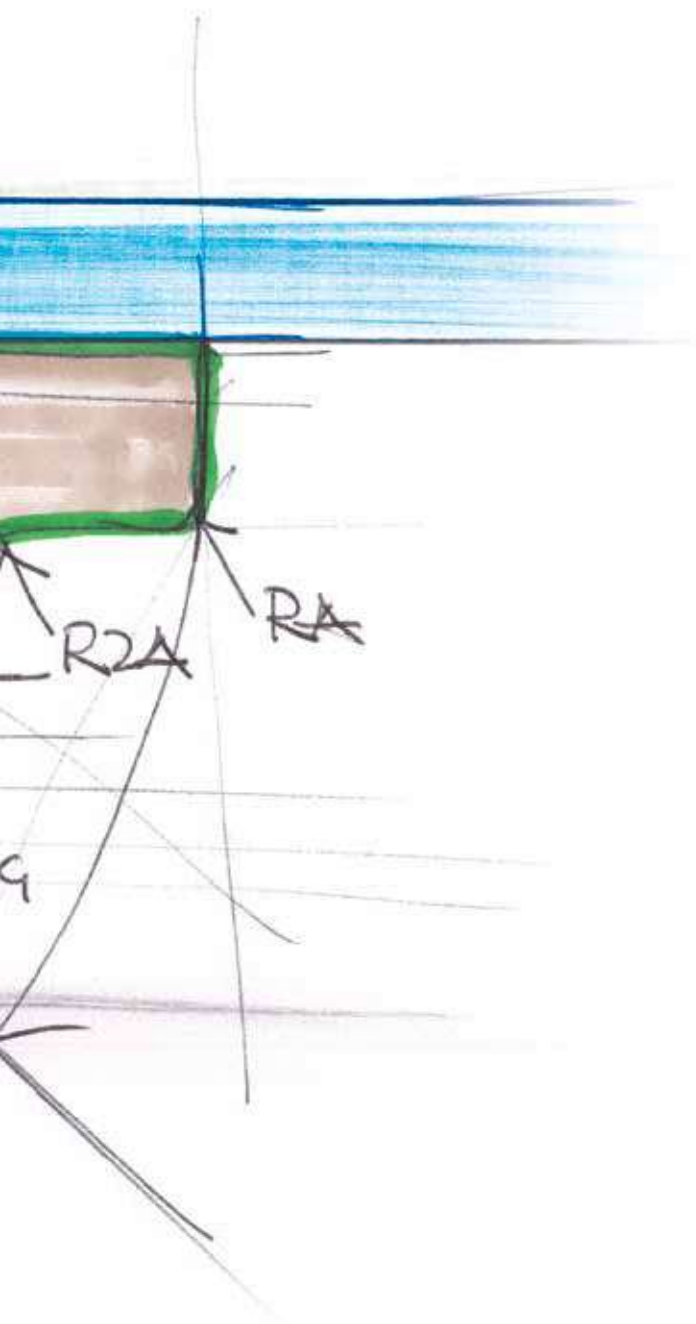

# PARETI VASCA

BOX DOCCIA  
E VASCA  
IN UN'UNICA  
SOLUZIONE:  
CONVENIENZA  
E PRATICITÀ.

Le rinunce non sono per tutti. Scegliere la soluzione due in uno realizza il desiderio di praticità e soddisfa la voglia di convenienza. I sopravasca Novellini offrono tutto il benessere e il piacere della vasca assieme alla comodità della doccia. Per rinnovare lo spazio o per nuove installazioni, senza dubbio è l'ideale per chi sa cosa vuole: funzionalità, facilità, sicurezza, versatilità.

# GALA 3V



150 cm



8 mm



2,5 cm



**PARETE VASCA, 1 FISSO E 1 ANTA GIREVOLE A 90° APERTURA SOLO ESTERNA**

Design Marco Pellici



## FINITURE VETRI



Trasparente  
cod 1

## FINITURE PROFILI



Cromo  
cod K

Misure		Codice	Destra	Sinistra	Scelta vetro	Scelta profilo
Misura effettiva d'ingombro	Anta fissa		D-	S-	1	K
	<b>F</b>				Trasparente	Cromo
<b>VERSIONE CON PROFILO A MURO</b>						
98↔100,5	23	<b>GALA13V100</b>	D-	S-		618 €

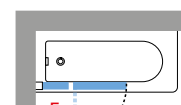
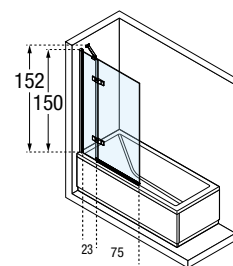

**S** Sinistra

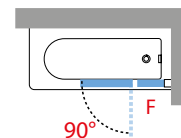

**D** Destra



# KUADRA 3V

PARETE VASCA, 1 FISSO E 1 ANTA GIREVOLE A 180°



150 cm



8 mm



3 cm



## FINITURE VETRI



Trasparente  
cod 1

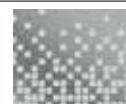

Ser. Ravenna  
cod 51

## FINITURE PROFILI



Bianco  
cod D



Silver  
cod B



Cromo  
cod K

Misure	Codice	Scelta vetro		Scelta profilo		
Misura effettiva d'ingombro		1	51	D	B	K
		Trasparente	Serigrafia Ravenna	Bianco	Silver	Cromo
97↔100	<b>KUAD3V100-</b>		+ 38 €	503 €	558 €	620 €

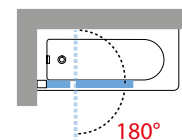
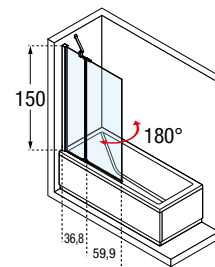

PARETI VASCA

Costruzione del codice **Codice** + **Vetro** + **Profilo** = Codice prodotto finale

# YOUNG 1V

PARETE VASCA, ANTA GIREVOLE A 180°



151,6 cm



6 mm



2 cm



## FINITURE VETRI



Trasparente  
cod 1



Aqua  
cod 2



Satin  
cod 4

## FINITURE PROFILI



Bianco  
opaco  
cod U



Silver  
cod B



Cromo  
cod K



Nero opaco  
cod H

Misure	Codice	Scelta vetro			Scelta profilo			
		1	2	4	U	B	K	H
Misura effettiva d'ingombro		Trasparente	Aqua	Satinato	Bianco opaco	Silver	Cromo	Nero opaco
70 x 151,6	<b>Y21V70-</b>				359 €	393 €	428 €	428 €
75 x 151,6	<b>Y21V75-</b>				373 €	408 €	445 €	445 €
80 x 151,6	<b>Y21V80-</b>		+ 38 €	+ 38 €	379 €	414 €	452 €	452 €
85 x 151,6	<b>Y21V85-</b>				394 €	429 €	468 €	468 €
90 x 151,6	<b>Y21V90-</b>				407 €	444 €	484 €	484 €

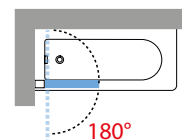
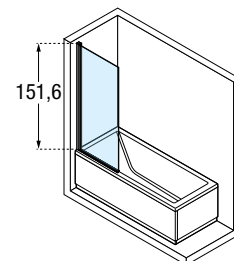

## KIT SOPRAVASCA DIVINA



Per il sopravasca Divina ordinare:  
1 sopravasca Young 1V +  
1 kit raccordo vasca

Codice	Scelta profilo		
	A	K	H
	Bianco	Cromo	Nero opaco
<b>KITYD1V-</b>	33 €	33 €	33 €

# YOUNG 3V

PARETE VASCA, 1 FISSO E 1 ANTA GIREVOLE A 180°



## FINITURE VETRI



Trasparente  
cod 1



Aqua  
cod 2



Satin  
cod 4

## FINITURE PROFILI



Bianco  
opaco  
cod U



Silver  
cod B



Cromo  
cod K



Nero opaco  
cod H

Misure	Codice	Scelta vetro			Scelta profilo			
		1	2	4	U	B	K	H
Misura effettiva d'ingombro		Trasparente	Aqua	Satinato	Bianco opaco	Silver	Cromo	Nero opaco
98 x 151,6	<b>Y23V100-</b>		+ 38 €	+ 38 €	454 €	495 €	542 €	542 €

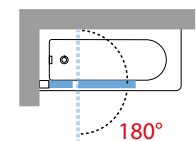
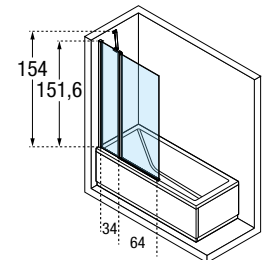

PARETI VASCA

Costruzione del codice **Codice** + **Vetro** + **Profilo** = Codice prodotto finale

# YOUNG 1BSV

PARETE VASCA, 2 ANTE RIPIEGABILI A SOFFIETTO



151,6 cm



6 mm



2 cm



## FINITURE VETRI



Trasparente  
cod 1



Aqua  
cod 2



Satin  
cod 4

## FINITURE PROFILI



Bianco  
opaco  
cod U



Silver  
cod B



Cromo  
cod K



Nero opaco  
cod H

Misure	Codice	Destra	Sinistra	Scelta vetro			Scelta profilo			
				1	2	4	U	B	K	H
Misura effettiva d'ingombro		D-	S-	Trasparente	Aqua	Satinato	Bianco opaco	Silver	Cromo	Nero opaco
120 x 151,6	<b>Y21BSV120</b>	D-	S-		+ 38 €	+ 38 €	550 €	607 €	668 €	668 €

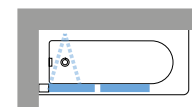
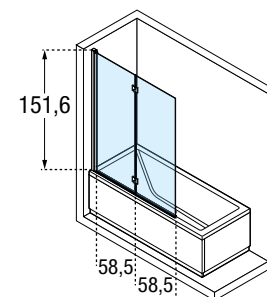

## KIT SOPRAVASCA DIVINA



Per il sopravasca Divina ordinare:  
1 sopravasca Young 1BSV +  
1 kit raccordo vasca

Codice	Scelta profilo		
	A	K	H
	Bianco	Cromo	Nero opaco
<b>KITYD1V-</b>	33 €	33 €	33 €

# ROSE ROSSE 3PV



150 cm

6 mm

6 cm porta

3 cm fisso

Fisso

## SOPRAVASCA, APERTURA 3 ANTE SCORREVOLI BILATERALI DA DESTRA E DA SINISTRA

Installabile in nicchia o abbinabile a fisso laterale ROSE VF



### FINITURE VETRI



Trasparente  
cod 1



Ser. Rose 1  
cod 56

### FINITURE PROFILI



Bianco  
cod D



Silver  
cod B



Cromo  
cod K

Misure		Codice	Scelta vetro		Scelta profilo		
Misura effettiva d'ingombro	Entrata (cm)		1	56	D	B	K
	*		Trasparente	Serigrafia rose 1	Bianco	Silver	Cromo
166↔172	86	<b>ROSE3PV166-</b>			1.049 €	1.143 €	1.248 €
176↔182	93	<b>ROSE3PV176-</b>		+ 38 €	1.078 €	1.174 €	1.280 €

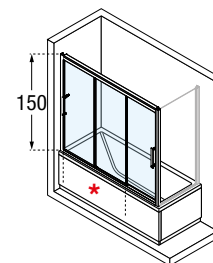

Misura effettiva d'ingombro	Entrata (cm)		1	56	D	B	K
<b>PARETE FISSA</b>							
		<b>F</b>					
68↔71	-	<b>ROSEVF68-</b>			328 €	359 €	393 €
78↔81	-	<b>ROSEVF78-</b>		+ 38 €	357 €	389 €	424 €

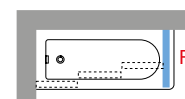
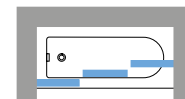

PARETI VASCA

Costruzione del codice **Codice** + **Vetro** + **Profilo** = Codice prodotto finale

# ROSE ROSSE 2PV



## SOPRAVASCA, APERTURA 1 ANTA SCORREVOLE E 1 FISSA IN LINEA

Installabile in nicchia o abbinabile a fisso laterale ROSE VF



### FINITURE VETRI

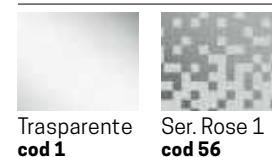

### FINITURE PROFILI



Misure			Codice	Destra	Sinistra	Scelta vetro		Scelta profilo		
Misura effettiva d'ingombro	Entrata (cm)					1	56	D	B	K
	*	<b>F1</b>				Trasparente	Serigrafia rose 1	Bianco	Silver	Cromo
166↔172	62	89	<b>ROSE2PV166</b>	D-	S-			923 €	1.015 €	1.119 €
176↔182	62	99	<b>ROSE2PV176</b>	D-	S-		+ 38 €	935 €	1.030 €	1.134 €

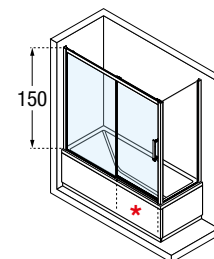

S Sinistra

Misura effettiva d'ingombro			D-	S-	1	56	D	B	K	
<b>PARETE FISSA</b>										
		<b>F</b>								
68↔71	-		<b>ROSEVF68-</b>	-	-		+ 38 €	328 €	359 €	393 €
78↔81	-		<b>ROSEVF78-</b>	-	-			357 €	389 €	424 €

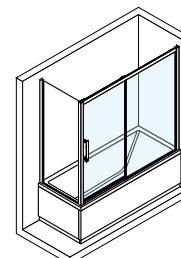

D Destra

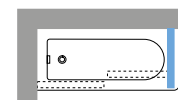
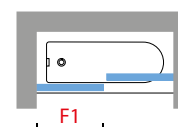



# AURORA 1

PARETE VASCA, ANTA GIREVOLE A 180°



150 cm



6 mm



3 cm



## FINITURE VETRI



Trasparente  
cod 1



Aqua  
cod 2



Satin  
cod 4

## FINITURE PROFILI



Bianco  
cod A



Silver  
cod B



Cromo  
cod K

Misure	Codice	Scelta vetro			Scelta profilo		
		1	2	4	A	B	K
Misura effettiva d'ingombro		Trasparente	Aqua	Satinato	Bianco	Silver	Cromo
70 X 150 H	<b>AURORAN170-</b>	●			288 €	318 €	350 €
75 X 150 H	<b>AURORAN175-</b>		+ 38 €		303 €	333 €	367 €
80 X 150 H	<b>AURORAN180-</b>	●		+ 38 €	317 €	349 €	383 €
85 X 150 H	<b>AURORAN185-</b>				330 €	364 €	402 €
L 45↔100 x H 100↑170	SPECIAL <b>AURORAN1SP</b>		+ 38 €	+ 38 €	403 €	444 €	489 €

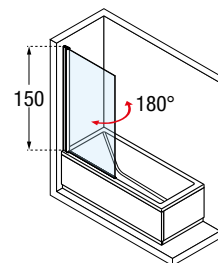

Misure	Codice	Scelta vetro			Scelta profilo		
		1	2	4	A	B	K
Misura effettiva d'ingombro							
<b>FISSO LATERALE</b>							
<b>F</b>							
67↔70	<b>AURORAN2FV70-</b>				413 €	457 €	500 €
72↔75	<b>AURORAN2FV75-</b>		+ 38 €	+ 38 €	425 €	469 €	519 €
77↔80	<b>AURORAN2FV80-</b>				438 €	482 €	532 €

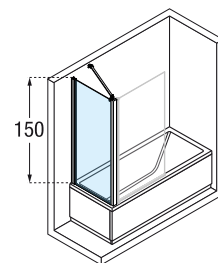

Costruzione del codice    **Codice** + **Vetro** + **Profilo** = Codice prodotto finale



# AURORA 2

PARETE VASCA, 2 ANTE A SOFFIETTO RIPIEGABILI ALL'INTERNO



## FINITURE VETRI



Trasparente  
cod 1

Aqua  
cod 2



Satin  
cod 4

## FINITURE PROFILI



Bianco  
cod A

Silver  
cod B



Cromo  
cod K

Misure	Codice	Scelta vetro			Scelta profilo		
		1	2	4	A	B	K
Misura effettiva d'ingombro		Trasparente	Aqua	Satinato	Bianco	Silver	Cromo
120 x 150 H	<b>AURORAN2-</b>		+ 38 €	+ 38 €	469 €	527 €	590 €
B1=30↔70 + B2=30↔60 x H 100;150	<b>AURORAN2SP</b>		+ 38 €	+ 38 €	570 €	639 €	717 €

## FISSO LATERALE

**F**

67↔70	<b>AURORAN2FV70-</b>			413 €	457 €	500 €
72↔75	<b>AURORAN2FV75-</b>	+ 38 €	+ 38 €	425 €	469 €	519 €
77↔80	<b>AURORAN2FV80-</b>			438 €	482 €	532 €

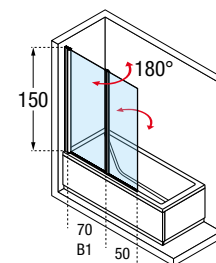

B2 ≤ B1 - 10 cm

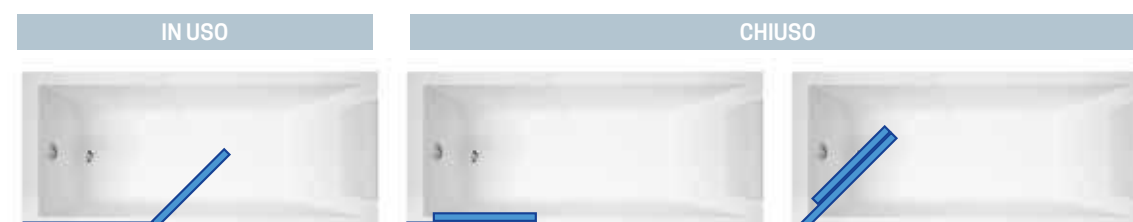
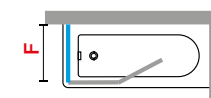
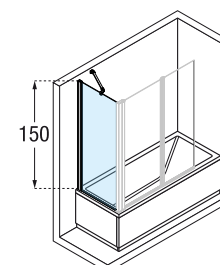
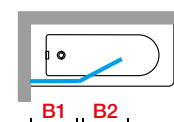

# AURORA 3

PARETE VASCA, 1 FISSO E 1 ANTA GIREVOLE A 180°



150 cm



6 mm



3 cm



## FINITURE VETRI



Trasparente  
cod 1



Aqua  
cod 2



Satin  
cod 4

## FINITURE PROFILI



Bianco  
cod A

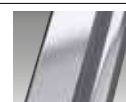

Silver  
cod B



Cromo  
cod K

Misure	Codice	Scelta vetro			Scelta profilo		
		1	2	4	A	B	K
Misura effettiva d'ingombro		Trasparente	Aqua	Satinato	Bianco	Silver	Cromo
98 x 150 H	<b>AURORAN3-</b>		+ 38 €	+ 38 €	390 €	440 €	498 €
30↔66 + 30↔80 x H 120↑170	<b>AURORAN3SP</b>		+ 38 €	+ 38 €	475 €	537 €	608 €

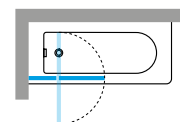
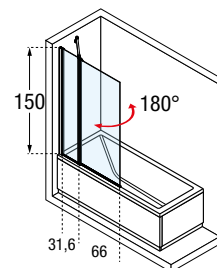

PARETI VASCA

Costruzione del codice **Codice** + **Vetro** + **Profilo** = Codice prodotto finale

# AURORA 4

SOPRAVASCA, DOPPIA APERTURA A 2 ANTE RIPIEGABILI A SOFFIETTO



150 cm 5 mm curva 6 mm dritta 3 cm



## FINITURE VETRI



Trasparente  
cod 1

## FINITURE PROFILI



Bianco  
cod A



Silver  
cod B



Cromo  
cod K

Misure	Codice	Scelta vetro	Scelta profilo		
Misura effettiva d'ingombro		1	A	B	K
70 x 150 H	<b>AURORA470-</b>	Trasparente	Bianco 939 €	Silver 1.042 €	Cromo 1.158 €
75 x 150 H	<b>AURORA475-</b>		939 €	1.042 €	1.158 €
80 x 150 H	<b>AURORA480-</b>		939 €	1.042 €	1.158 €

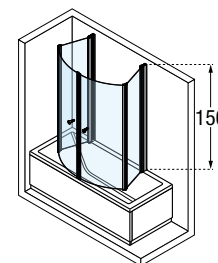

	A	B	C	D	E	F
70 cm	81	67	154	55	99,5	13,2
75 cm	81	72	164	55	99,5	13,2
80 cm	81	77	174	55	99,5	13,2

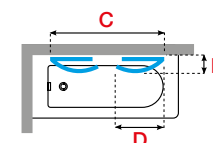
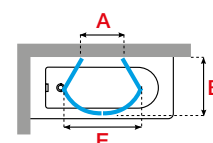

# AURORA 5

PARETE VASCA, 1 ANTA FISSA



150 cm



6 mm



3 cm



## FINITURE VETRI



Trasparente  
cod 1

## FINITURE PROFILI



Bianco  
cod A



Silver  
cod B



Cromo  
cod K

Misure	Codice	Scelta vetro	Scelta profilo		
Misura effettiva d'ingombro		1	A	B	K
70	<b>AURORA570-</b>	Trasparente	Bianco 265 €	Silver 299 €	Cromo 339 €
75	<b>AURORA575-</b>		280 €	318 €	359 €
80	<b>AURORA580-</b>		294 €	333 €	377 €
85	<b>AURORA585-</b>		310 €	352 €	398 €
H 100 ↓ 160 X L 40 ↔ 85 cm	<b>AURORAN5SP</b>		379 €	429 €	487 €

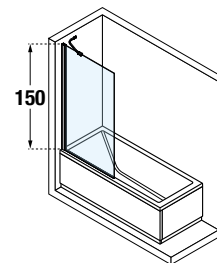

# AURORA 9

SOPRAVASCA, 3 ANTE A SOFFIETTO



138 cm



3 mm



## FINITURE VETRI



Trasparente  
cod 1



Piumato  
cod 3



Anelli  
cod 16

## FINITURE PROFILI



Bianco  
cod A

Misure	Codice	Scelta vetro		Scelta profilo	Scelta acrilico	Scelta profilo
		1	3	A	16	A
Misura effettiva d'ingombro		Trasparente	Piumato	Bianco	Anelli	Bianco
138	<b>AURORA93V-</b>		+ 38 €	493 €		435 €

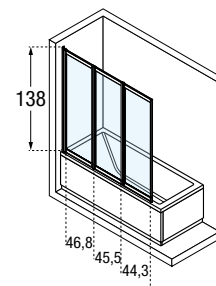

# AURORA 3PV4



150 cm



3 mm



6 cm



## SOPRAVASCA, APERTURA 3 ANTE SCORREVOLI BILATERALI DA DESTRA E DA SINISTRA

Installabile in nicchia o abbinabile a pannello fisso laterale AURORA VFL4



### FINITURE VETRI



Trasparente  
cod 1



Piumato  
cod 3



Ser. Esprit  
cod 5



Circolare  
cod 43

### FINITURE PROFILI



Bianco  
cod A



Silver  
cod B



Cromo  
cod K

Misure		Codice	Scelta vetro			Scelta profilo			Scelta acrilico	Scelta profilo		
Misura effettiva d'ingombro	Entrata (cm)		1	3	5	A	B	K	43	A	B	K
<b>A</b>	*		Traspa- rente	Piumato	Serigrafia esprit	Bianco	Silver	Cromo	Circolare	Bianco	Silver	Cromo
138↔144	83	<b>AURORA3PV138-</b>				767 €	844 €	929 €		729 €	788 €	890 €
144↔150	87	<b>AURORA3PV144-</b>				767 €	844 €	929 €		729 €	788 €	890 €
150↔156	91	<b>AURORA3PV150-</b>				794 €	874 €	963 €		755 €	818 €	924 €
156↔162	95	<b>AURORA3PV156-</b>		+ 38 €	+ 38 €	794 €	874 €	963 €		755 €	818 €	924 €
162↔168	99	<b>AURORA3PV162-</b>				794 €	874 €	963 €		755 €	818 €	924 €
168↔174	103	<b>AURORA3PV168-</b>				823 €	905 €	997 €		783 €	845 €	957 €
174↔180	107	<b>AURORA3PV174-</b>				823 €	905 €	997 €		783 €	845 €	957 €

### PORTE SPECIALI IN LARGHEZZA

L 180↔186	111	<b>AURORA3PV180-</b>								863 €	932 €	-
-----------	-----	----------------------	--	--	--	--	--	--	--	-------	-------	---

### PORTE SPECIALI IN ALTEZZA

H 80↔160		<b>AURORA3PVSP</b>	+ 38 €	-		1.028 €	1.132 €	1.244 €		978 €	1.057 €	1.194 €
L 96↔186												

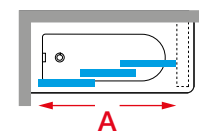
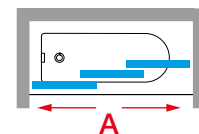
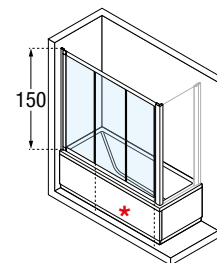

PARETI VASCA

Costruzione del codice **Codice** + **Vetro** + **Profilo** = Codice prodotto finale

# AURORA 2PV4



150 cm



4 mm



6 cm



## SOPRAVASCA, APERTURA 1 ANTA SCORREVOLE E 1 FISSA IN LINEA

Installabile in nicchia o abbinabile a pannello fisso laterale AURORA VFL4



### FINITURE VETRI



Trasparente  
cod 1



Piumato  
cod 3



Ser. Esprit  
cod 5

### FINITURE PROFILI



Bianco  
cod A



Silver  
cod B



Cromo  
cod K

Misure			Codice	Scelta vetro			Scelta profilo		
Misura effettiva d'ingombro	Anta fissa	Entrata (cm)		1	3	5	A	B	K
<b>A</b>	<b>F1</b>	*		Trasparente	Piumato	Serigrafia esprit	Bianco	Silver	Cromo
138↔144	68	60	<b>AURORA2PV138-</b>				732 €	804 €	885 €
144↔150	71	63	<b>AURORA2PV144-</b>				732 €	804 €	885 €
150↔156	74	66	<b>AURORA2PV150-</b>		+ 38 €	+ 38 €	759 €	835 €	920 €
156↔162	77	69	<b>AURORA2PV156-</b>				759 €	835 €	920 €
166↔172	82	74	<b>AURORA2PV166-</b>				788 €	867 €	953 €
176↔182	87	79	<b>AURORA2PV176-</b>				788 €	867 €	953 €

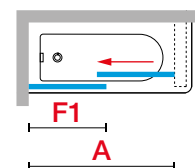
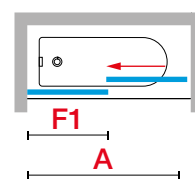
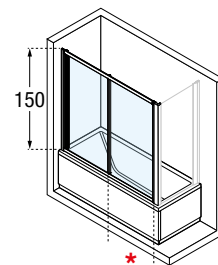



# AURORA VFL4



## PARETE FISSA LATERALE

Per porte sopravasca AURORA 2AV4, 2PV4, 2SV4 e 3PV4



### FINITURE VETRI



### FINITURE PROFILI



Misure	Codice	Scelta vetro			Scelta profilo			Scelta acrilico	Scelta profilo		
		1	3	5	A	B	K		43	A	B
Misura effettiva d'ingombro		Trasparente	Piumato	Serigrafia esprit	Bianco	Silver	Cromo	Circolare	Bianco	Silver	Cromo
62↔68	<b>AURORAVFL62-</b>				228 €	250 €	277 €		205 €	227 €	249 €
68↔74	<b>AURORAVFL68-</b>		+ 38 €	+ 38 €	244 €	270 €	297 €		220 €	243 €	268 €
74↔80	<b>AURORAVFL74-</b>				257 €	284 €	314 €		233 €	255 €	283 €
L 20↔100 H 80↔160	<b>AURORAVFLSP</b>		+ 38 €	-	319 €	352 €	387 €		288 €	318 €	350 €

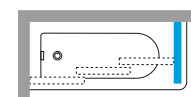
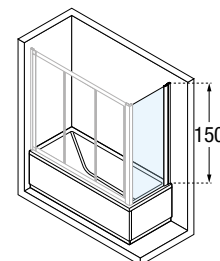

**PER LE SOLUZIONI CON 2 PANNELLI FISSI LATERALI, UTILIZZARE SEMPRE 2 BARRE DI SOSTEGNO AD ANGOLO**

Costruzione del codice **Codice** + **Vetro** + **Profilo** = Codice prodotto finale

# RIVIERA 1V

PARETE VASCA, ANTA GIREVOLE A 180°



150 cm



6 mm



## FINITURE VETRI



Trasparente  
cod 1

## FINITURE PROFILI



Bianco  
cod A



Silver  
cod B

Misure	Codice	Scelta vetro	Scelta profilo	
			A	B
Misura effettiva d'ingombro		1		
		Trasparente	Bianco	Silver
70	<b>RIV21V70-</b>		275 €	302 €
75	<b>RIV21V75-</b>		287 €	315 €
80	<b>RIV21V80-</b>		298 €	328 €
85	<b>RIV21V85-</b>		309 €	339 €

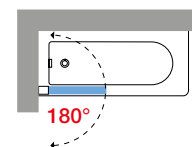
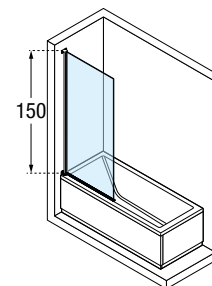

## DATI TECNICI

### FINITURE PROFILI

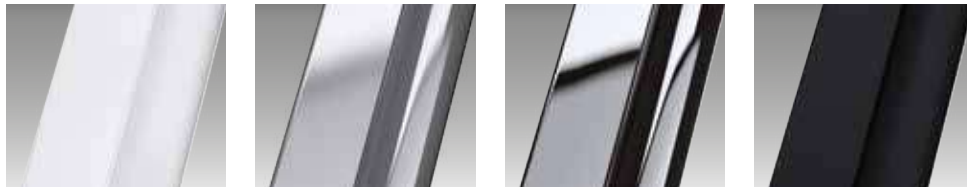

Bianco  
cod. A-D

Silver  
cod. B

Cromo  
cod. K



Nero  
cod. H

### VETRO TEMPRATO (European Standards UNI EN 14428)



Trasparente  
cod. 1



Aqua  
cod. 2  
(solo per Young 2.0 1V, 3V,  
1BSV, Aurora 1, 2, 3)

Piumato  
cod. 3  
(solo per Aurora 9, 3PV4,  
2SV4, VFL4)

Satin  
cod. 4  
(solo per Young 2.0 1V,  
3V, 1BSV, Aurora 1, 2, 3)

### SERIGRAFIA



Rose 1  
cod. 56  
(solo per Rose Rosse 3PV,  
2PV, PHV+F)

Esprit  
cod. 5  
(solo per Aurora 3PV4,  
2SV4, VFL4)

Ravenna  
cod. 51  
(solo per Kuadra 3V)

### ACRILICO



Circolare  
cod. 43  
(solo per Aurora 3PV4,  
VFL4)

Anelli  
cod. 16  
(solo per Aurora 9)

### COME RILEVARE LE MISURE

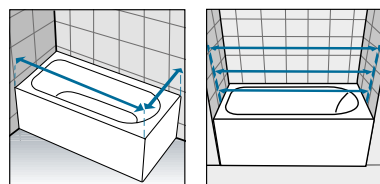

Rilevare le misure da muro a bordo esterno della vasca. Le misure devono essere rilevate sulla parete finita, a rivestimenti posati, secondo gli schemi riportati.





# COMPLEMENTI

IL PERFETTO  
ACCESSORIO PER  
TUTTI I NOSTRI  
PRODOTTI BAGNO

La gamma Novellini include una vasta selezione di accessori per la tua doccia, cabina o vasca da bagno. Sgabelli e sedili doccia, porta asciugamani da terra e da muro, tergovetro, appendini per vetro e a parete, maniglioni di sicurezza e cestelli doccia in filo metallico o in acciaio inox con vaschetta. C'è tutto ciò che serve per fare del tuo bagno la soluzione di stile perfetta per le tue esigenze.



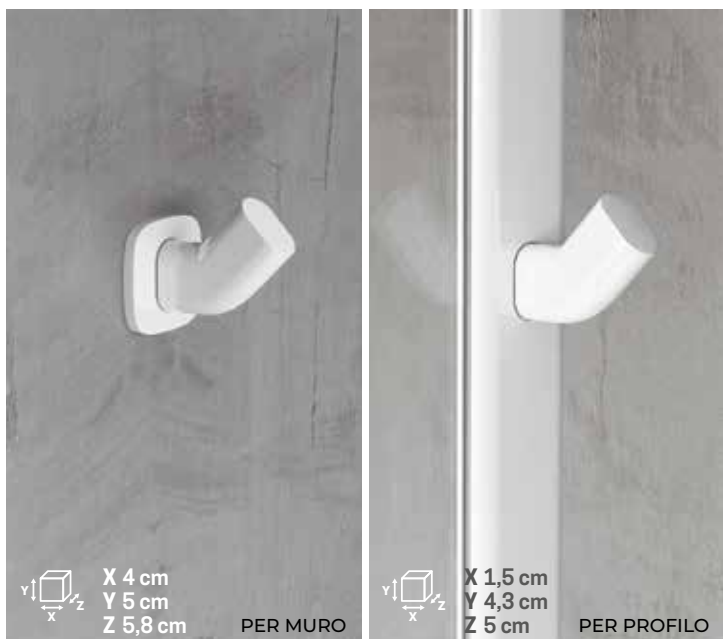

### APPENDIABITI SINGOLO

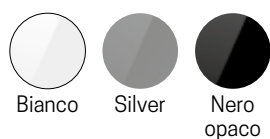

#### MURO

Codice	Scelta finitura / prezzo		
	A	B	H
	Bianco	Silver	Nero opaco
<b>R90AGEPAM-</b>	38 €	44 €	50 €

#### PROFILO

Codice	Scelta finitura / prezzo		
	A	B	H
	Bianco	Silver	Nero opaco
<b>R90AGEPAP-</b>	32 €	38 €	44 €

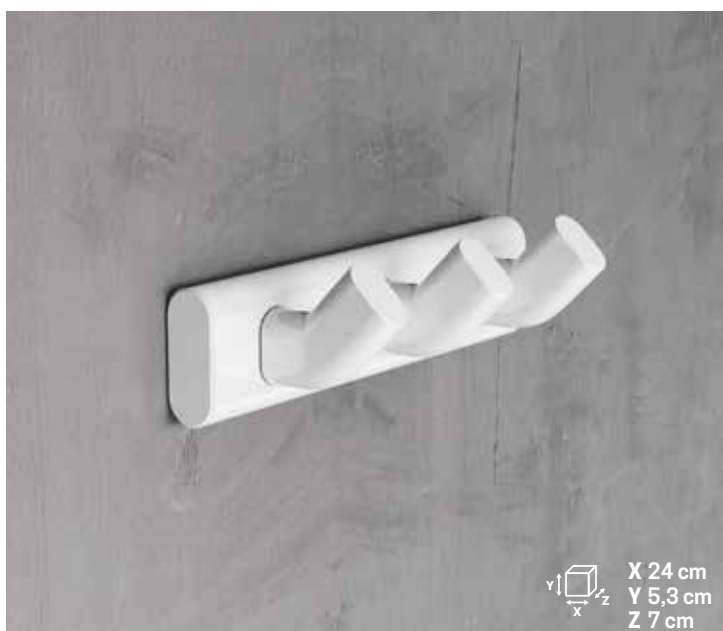

### APPENDIABITI MULTIPLO

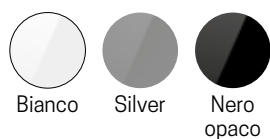

Codice	Scelta finitura / prezzo		
	A	B	H
	Bianco	Silver	Nero opaco
<b>R90AGEPAM3-</b>	125 €	138 €	150 €

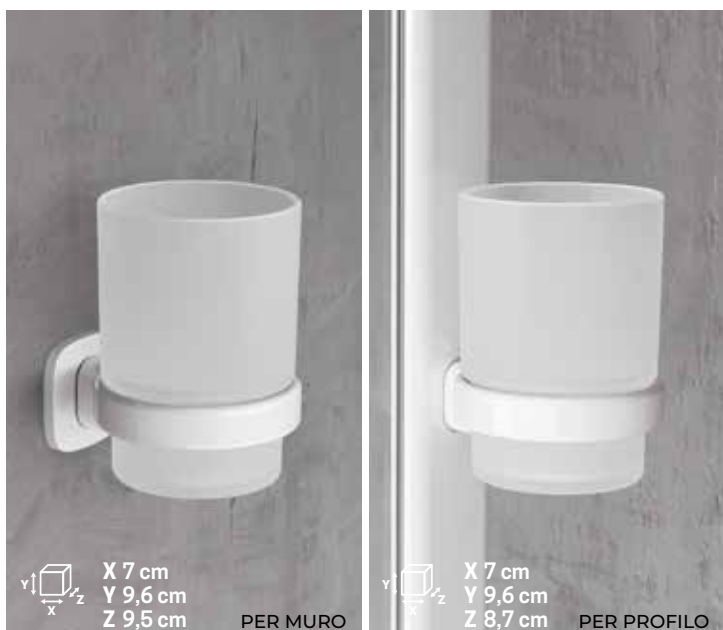

### BICCHIERE

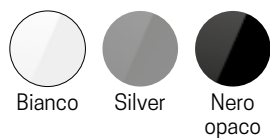

#### MURO

Codice	Scelta finitura / prezzo		
	A	B	H
	Bianco	Silver	Nero opaco
<b>R90AGEBIM-</b>	69 €	75 €	82 €

#### PROFILO

Codice	Scelta finitura / prezzo		
	A	B	H
	Bianco	Silver	Nero opaco
<b>R90AGEBIP-</b>	63 €	69 €	75 €



**DOSASAPONE**



**MURO**

Codice	Scelta finitura / prezzo		
	A	B	H
	Bianco	Silver	Nero opaco
<b>R90AGEDSM-</b>	82 €	88 €	94 €

**PROFILO**

Codice	Scelta finitura / prezzo		
	A	B	H
	Bianco	Silver	Nero opaco
<b>R90AGEDSP-</b>	75 €	82 €	88 €



**PORTA-PHON**

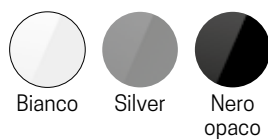

**MURO**

Codice	Scelta finitura / prezzo		
	A	B	H
	Bianco	Silver	Nero opaco
<b>R90AGEPPM-</b>	44 €	50 €	57 €



**PORTA-TERGIVETRO**  
(tergivetrol non incluso)



**MURO**

Codice	Scelta finitura / prezzo		
	A	B	H
	Bianco	Silver	Nero opaco
<b>R90AGEPRM-</b>	38 €	44 €	50 €

**PROFILO**

Codice	Scelta finitura / prezzo		
	A	B	H
	Bianco	Silver	Nero opaco
<b>R90AGEPRP-</b>	32 €	38 €	44 €





### MENSOLA

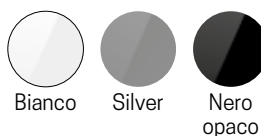

### MURO

Codice	Scelta finitura / prezzo		
	A	B	H
	Bianco	Silver	Nero opaco
<b>R90AGEMEM-</b>	63 €	69 €	75 €

### PROFILO

Codice	Scelta finitura / prezzo		
	A	B	H
	Bianco	Silver	Nero opaco
<b>R90AGEMEP-</b>	57 €	63 €	69 €



### PORTA-ROTOLO

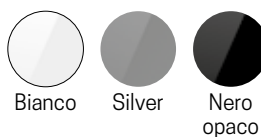

Codice	Scelta finitura / prezzo		
	A	B	H
	Bianco	Silver	Nero opaco
<b>R90AGEPT-</b>	107 €	113 €	119 €



### PORTA-SCOPINO

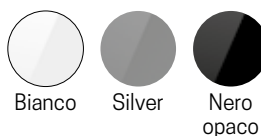

Codice	Scelta finitura / prezzo		
	A	B	H
	Bianco	Silver	Nero opaco
<b>R90AGEPS-</b>	88 €	100 €	113 €



X 8,5 cm  
Y 65 cm  
Z 12,2 cm

## PORTA-ROTOLO E PORTA-SCOPINO

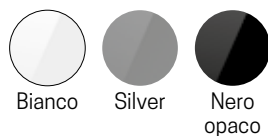

Codice	Scelta finitura / prezzo		
	A	B	H
	Bianco	Silver	Nero opaco
<b>R90AGEPTPS-</b>	200 €	219 €	238 €



X 90 cm  
Y 4,5 cm  
Z 10 cm

## PORTA-SALVIETTA CON MENSOLA LUMINOSA

da abbinare a vasca Divina, Calos 2.0, Stile, Sense 3-4 e Sense 2.0 3-4 con pannello in legno

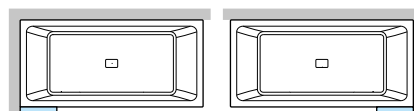

S Sinistra

D Destra

Misure (cm)	Codice	Destra	Sinistra	Scelta finitura / prezzo		
		D-	S-	A	B	H
				Bianco	Silver	Nero opaco
90	<b>R90AGEBPSML</b>	D-	S-	413 €	438 €	463 €



X 146/166/176 cm  
Y 4,5 cm  
Z 9 cm

## MENSOLA LUMINOSA CON PORTA OGGETTI

da abbinare a vasca Divina, Calos 2.0, Stile, Sense 3-4 e Sense 2.0 3-4 con pannello in legno

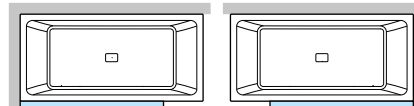
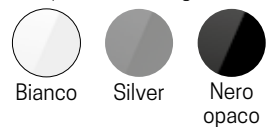

S Sinistra

D Destra

Misura vasca (cm)	Codice	Destra	Sinistra	Scelta finitura / prezzo		
		D-	S-	A	B	H
				Bianco	Silver	Nero opaco
150-160	<b>R90AGEBPSM150</b>	D-	S-	344 €	369 €	394 €
170	<b>R90AGEBPSM170</b>	D-	S-	357 €	382 €	407 €
180-190	<b>R90AGEBPSM180</b>	D-	S-	369 €	394 €	419 €



X 30/45/65 cm  
Y 4,5 cm  
Z 10 cm

## PORTA-SALVIETTA

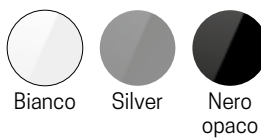

Misure (cm)	Codice	Scelta finitura / prezzo		
		A	B	H
30	<b>R90AGEBPS30-</b>	Bianco 113 €	Silver 119 €	Nero opaco 125 €
45	<b>R90AGEBPS45-</b>	125 €	132 €	138 €
65	<b>R90AGEBPS65-</b>	132 €	138 €	150 €



## TERGIVETRO

Tergivetro in metallo cromato e gomma (appendino escluso)

Codice	Prezzo
<b>R90RACLA0B</b>	74 €

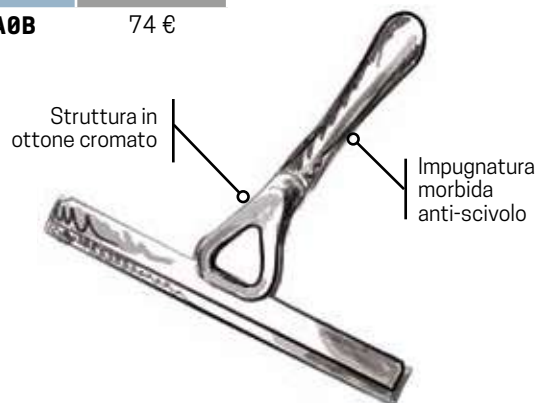

## TERGIVETRO

Tergivetro in metallo cromato e gomma (appendino escluso)

Codice	Prezzo
<b>R90RACLA0A</b>	39 €

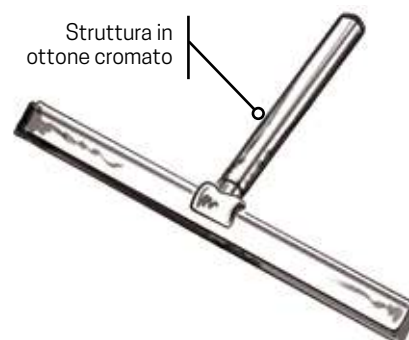

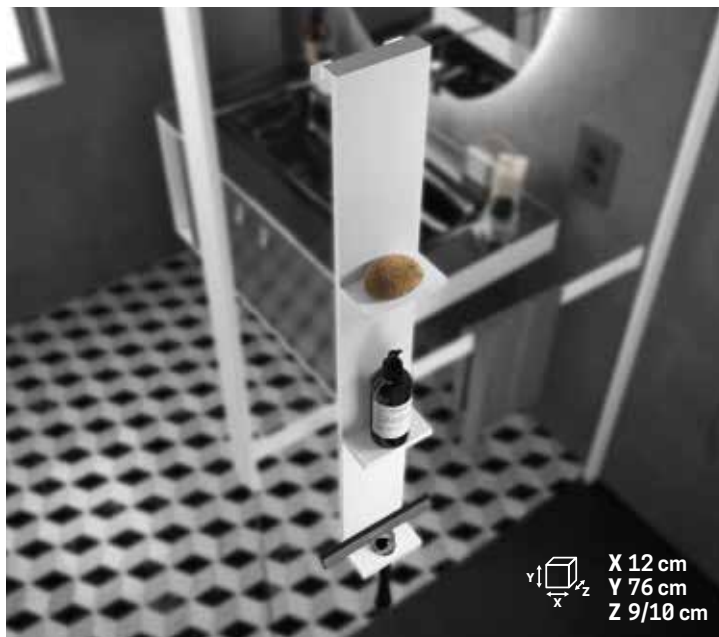

X 12 cm  
Y 76 cm  
Z 9/10 cm

## ACCESSORIO DA AGGANCIARE AL VETRO CON MENSOLE + PORTA-TERGIVETRO E APPENDIABITI ESTERNO (Tergivetro non incluso)

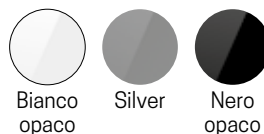

Misure (cm)	Codice	Scelta finitura / prezzo		
		U	B	H
12 x 76	<b>R90AKFP01290-</b>	Bianco opaco	Silver	Nero opaco
		125 €	138 €	150 €



X 35 cm  
Y 90 cm  
Z 8,5/8,5 cm

## MENSOLE INTERNA E PORTA SALVIETTE ESTERNO DA AGGANCIARE AL VETRO

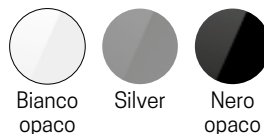

Misure (cm)	Codice	Scelta finitura / prezzo		
		U	B	H
35 x 90	<b>R90AKFPSP03590-</b>	Bianco opaco	Silver	Nero opaco
		300 €	325 €	350 €



X 35 cm  
Y 90 cm  
Z 8,5 cm

## TRE MENSOLE INTERNE E APPENDIABITI ESTERNO DA AGGANCIARE AL VETRO

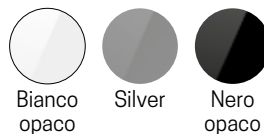

Misure (cm)	Codice	Scelta finitura / prezzo		
		U	B	H
35 x 90	<b>R90AKFP03590-</b>	Bianco opaco	Silver	Nero opaco
		275 €	294 €	313 €



### MENSOLA INTERNA E APPENDIBILI ESTERNO DA AGGANCIARE AL VETRO



Misure (cm)	Codice	Scelta finitura / prezzo		
		U	B	H
		Bianco opaco	Silver	Nero opaco
40 x 60	<b>R90AKFP04070-</b>	113 €	119 €	125 €

X 60 cm  
Y 40 cm  
Z 8,5 cm



### MENSOLA

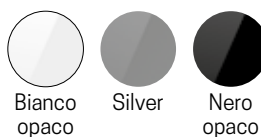

Misure (cm)	Codice	Scelta finitura / prezzo		
		U	B	H
		Bianco opaco	Silver	Nero opaco
9,7 x 17,5	<b>R90AKFME17-</b>	75 €	82 €	88 €
9,7 x 30	<b>R90AKFME30-</b>	82 €	88 €	94 €
9,7 x 45	<b>R90AKFME45-</b>	88 €	94 €	100 €

X 17,5/30/45 cm  
Y 1,2 cm  
Z 9,7 cm



### PORTA SAPONE DA APPOGGIO IN SOLID SURFACE (mensola non inclusa)



Misure (cm)	Codice	Scelta finitura / prezzo
		U
		Bianco opaco
9,7 x 12	<b>R90AKFBS01-</b>	50 €

X 12 cm  
Y 1,2 cm  
Z 9,7 cm



## MENSOLA CON FORO PORTA-TERGIVETRO

(tergivetrol non incluso)

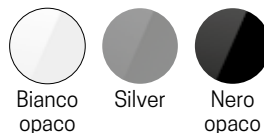

Misure (cm)	Codice	Scelta finitura / prezzo		
		U	B	H
		Bianco opaco	Silver	Nero opaco
9,7 x 30	<b>R90AKFMPR30-</b>	88 €	94 €	100 €
9,7 x 45	<b>R90AKFMPR45-</b>	113 €	119 €	125 €

TERGIVETRO in metallo cromato e gomma

Codice	Prezzo
<b>R90RACLA0B</b>	74 €



## MENSOLA CON BICCHIERE E DOSATORE PER SAPONE

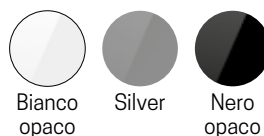

Misure (cm)	Codice	Scelta finitura / prezzo		
		U	B	H
		Bianco opaco	Silver	Nero opaco
9,7 x 30	<b>R90AKFMPB30-</b>	157 €	163 €	169 €
9,7 x 45	<b>R90AKFMPB45-</b>	200 €	207 €	213 €



## MENSOLA CON FRONTALE

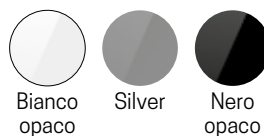

Misure (cm)	Codice	Scelta finitura / prezzo		
		U	B	H
		Bianco opaco	Silver	Nero opaco
10,9 x 35	<b>R90AKFMMA135-</b>	157 €	163 €	169 €
10,9 x 50	<b>R90AKFMMA150-</b>	169 €	175 €	182 €
10,9 x 65	<b>R90AKFMMA165-</b>	182 €	188 €	194 €



X 80/120/140 cm  
Y 8,5 cm  
Z 10,9 cm

### MENSOLA CON FRONTALE E PORTA SALVIETTE A SBALZO

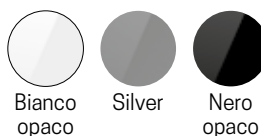

Misure (cm)	Codice	Scelta finitura / prezzo		
		U	B	H
		Bianco opaco	Silver	Nero opaco
10,9 x 80	<b>R90AKFMMA380-</b>	175 €	182 €	188 €
10,9 x 120	<b>R90AKFMMA3120-</b>	194 €	200 €	207 €
10,9 x 140	<b>R90AKFMMA3140-</b>	213 €	219 €	225 €



X 100/110 cm  
Y 8,5 cm  
Z 10,9 cm



### MENSOLA L. 70 E 80 CM CON FRONTALE A SBALZO, PORTA SALVIETTE E CON BICCHIERE E DOSATORE PER SAPONE

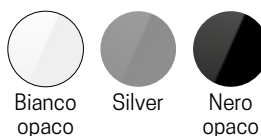

Misure (cm)	Codice	Destra	Sinistra	Scelta finitura / prezzo		
		D-	S-	U	B	H
				Bianco opaco	Silver	Nero opaco
10,9 x 100	<b>R90AKFMMA2100F</b>	D-	S-	332 €	338 €	344 €
10,9 x 110	<b>R90AKFMMA2110F</b>	D-	S-	344 €	350 €	357 €



X 100/110 cm  
Y 8,5 cm  
Z 10,9 cm

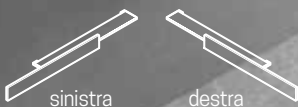

### MENSOLA L. 70 E 80 CM CON FRONTALE A SBALZO PORTA SALVIETTE

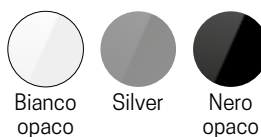

Misure (cm)	Codice	Destra	Sinistra	Scelta finitura prezzo		
		D-	S-	U	B	H
				Bianco opaco	Silver	Nero opaco
10,9 x 100	<b>R90AKFMMA2100</b>	D-	S-	175 €	182 €	188 €
10,9 x 110	<b>R90AKFMMA2110</b>	D-	S-	188 €	194 €	200 €



X 85/110 cm  
 Y 1,2 cm  
 Z 12,5 cm

## MENSOLA SOVRAPPONIBILE A SPECCHI (CON SPESSORE MAX 35mm)

(specchio non incluso)

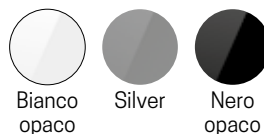

Misure (cm)	Codice	Scelta finitura / prezzo		
		U	B	H
		Bianco opaco	Silver	Nero opaco
12,5 x 85	<b>R90AKFMS85-</b>	175 €	182 €	188 €
12,5 x 110	<b>R90AKFMS110-</b>	175 €	182 €	188 €

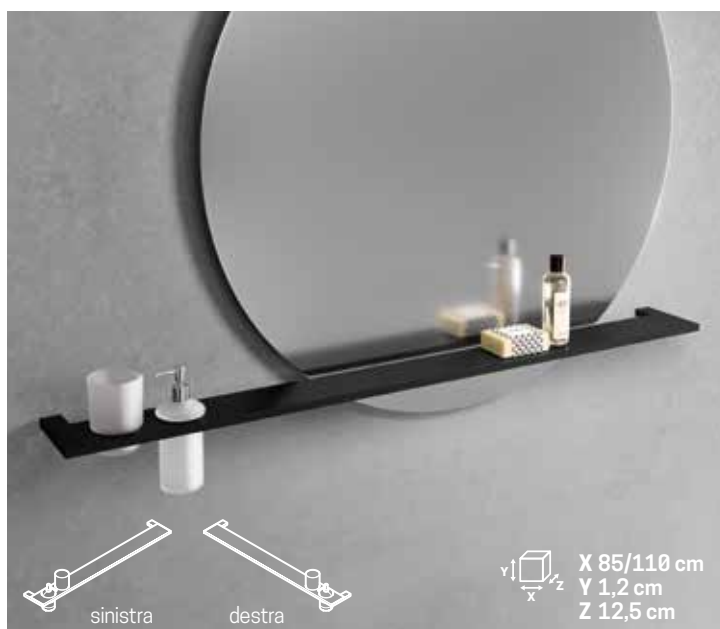

X 85/110 cm  
 Y 1,2 cm  
 Z 12,5 cm

sinistra      destra

## MENSOLA CON BICCHIERE E DOSATORE SAPONE, SOVRAPPONIBILE A SPECCHI (CON SPESSORE MAX 35mm)

(specchio non incluso)

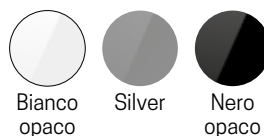

Misure (cm)	Codice	Destra	Sinistra	Scelta finitura / prezzo		
		D-	S-	U	B	H
				Bianco opaco	Silver	Nero opaco
12,5 x 85	<b>R90AKFMSF85</b>	D-	S-	332 €	338 €	344 €
12,5 x 110	<b>R90AKFMSF110</b>	D-	S-	332 €	338 €	344 €



X 61,2 cm  
 Y 6 cm  
 Z 35 cm

## MENSOLA DOGATA PORTA ASCIUGAMANI

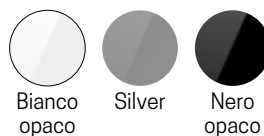

Misure (cm)	Codice	Scelta finitura / prezzo		
		U	B	H
		Bianco opaco	Silver	Nero opaco
35 x 61,2	<b>R90AKFPA-</b>	325 €	350 €	375 €





### PORTA SALVIETTE

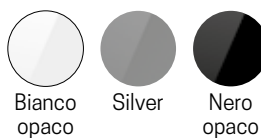

Misure (cm)	Codice	Scelta finitura / prezzo		
		U	B	H
		Bianco opaco	Silver	Nero opaco
9 x 30	<b>R90AKFPS0130-</b>	119 €	125 €	132 €
9 x 45	<b>R90AKFPS0145-</b>	125 €	132 €	138 €
9 x 60	<b>R90AKFPS0160-</b>	144 €	150 €	157 €



### PORTA SALVIETTE DOPPIO

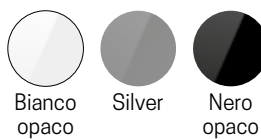

Misure (cm)	Codice	Scelta finitura / prezzo		
		U	B	H
		Bianco opaco	Silver	Nero opaco
10 x 30	<b>R90AKFPS0230-</b>	138 €	144 €	157 €
10 x 45	<b>R90AKFPS0245-</b>	144 €	157 €	169 €
10 x 60	<b>R90AKFPS0260-</b>	150 €	163 €	175 €



### PORTA SALVIETTE CON MENSOLA INTERNA

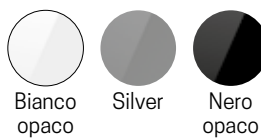

Misure (cm)	Codice	Scelta finitura / prezzo		
		U	B	H
		Bianco opaco	Silver	Nero opaco
12 x 30	<b>R90AKFMPS30-</b>	144 €	150 €	157 €
12 x 45	<b>R90AKFMPS45-</b>	157 €	163 €	169 €
12 x 60	<b>R90AKFMPS60-</b>	169 €	175 €	182 €



X 40 cm  
Y 4,2 cm  
Z 6 cm

## PORTA SALVIETTE FIANCO MOBILE



Misure (cm)	Codice	Scelta finitura / prezzo		
		U	B	H
		Bianco opaco	Silver	Nero opaco
6 x 40	<b>R90AKFMPS140-</b>	100 €	107 €	113 €



X 6 cm  
Y 4 cm  
Z 3,3 cm

## APPENDIABITI A MURO



Misure (cm)	Codice	Scelta finitura / prezzo		
		U	B	H
		Bianco opaco	Silver	Nero opaco
6 x 4	<b>R90AKFPAQM-</b>	50 €	57 €	63 €



X 12 cm  
Y 4 cm  
Z 3,3 cm

## APPENDIABITI DOPPIO

12 x 4	<b>R90AKFPAQM2-</b>	100 €	113 €	125 €
--------	---------------------	-------	-------	-------



X 21,2 cm  
Y 16,1 cm  
Z 9,7 cm



X 21,2 cm  
Y 31,1 cm  
Z 9,7 cm

## PORTAROTOLO SINGOLO / DOPPIO



### PORTAROTOLO SINGOLO

Misure (cm)	Codice	Scelta finitura / prezzo		
		U	B	H
		Bianco opaco	Silver	Nero opaco
16,2 x 21,2	<b>R90AKFPR16-</b>	119 €	125 €	132 €

### PORTAROTOLO DOPPIO

31,2 x 21,2	<b>R90AKFPR31-</b>	157 €	169 €	182 €
-------------	--------------------	-------	-------	-------



X 21,2 cm  
Y 75 cm  
Z 9,7 cm

### PORTA ROTOLO SINGOLO + PORTA SCOPINO

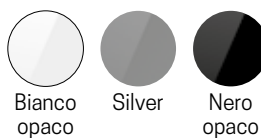

Misure (cm)	Codice	Scelta finitura / prezzo		
		U	B	H
21,2 x 75	<b>R90AKFPRS-</b>	Bianco opaco	Silver	Nero opaco
		263 €	282 €	300 €



X 47 cm  
Y 75 cm  
Z 15 cm

### COLONNA PORTA SALVIETTE, PORTA ROTOLO E PORTA SCOPINO

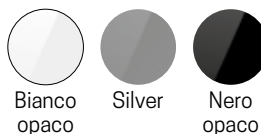

Misure (cm)	Codice	Scelta finitura / prezzo		
		U	B	H
47 x 75	<b>R90AKFPRS-</b>	Bianco opaco	Silver	Nero opaco
		350 €	375 €	400 €



X 35 cm  
Y 75 cm  
Z 15 cm

### COLONNA PORTA SALVIETTE

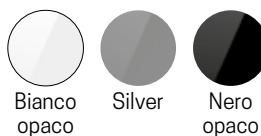

Misure (cm)	Codice	Scelta finitura / prezzo		
		U	B	H
35 x 75	<b>R90AKFPS-</b>	Bianco opaco	Silver	Nero opaco
		238 €	257 €	275 €

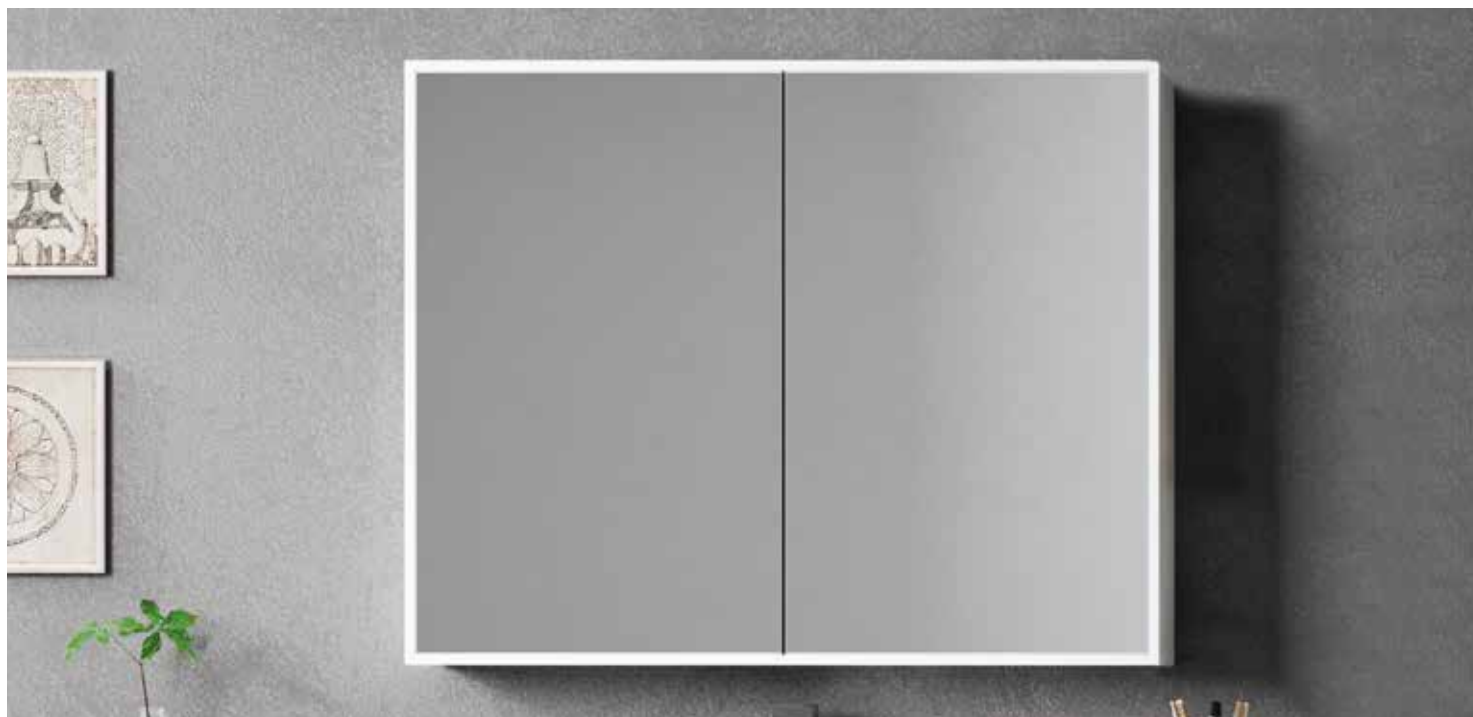

## “SLIDE” SPECCHI CONTENITORI STRUTTURA ALLUMINIO PROF. 14 CM SENZA ILLUMINAZIONE

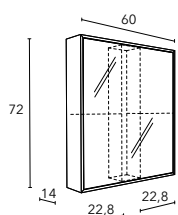

un'anta a specchio

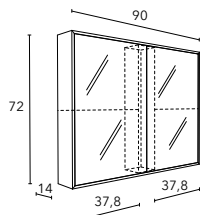

due ante a specchio

Misure				Codice	Prezzo		
Altezza	Largh. Specchio	Largh. Anta	U		B	H	
					Bianco	Silver	Nero
<b>UN'ANTA A SPECCHIO SENZA SCHIENA</b>							
72	60	60	Cerniere a destra	<b>D4EPM8S6</b>	687 €	687 €	687 €
72	60	60	Cerniere a sinistra	<b>S4EPM8S6</b>	687 €	687 €	687 €
<b>UN'ANTA A SPECCHIO CON SCHIENA A SPECCHIO</b>							
72	60	60	Cerniere a destra	<b>D4EPP8S6</b>	809 €	809 €	809 €
72	60	60	Cerniere a sinistra	<b>S4EPP8S6</b>	809 €	809 €	809 €
<b>UN'ANTA A SPECCHIO SENZA SCHIENA</b>							
72	90	45X2	-	<b>L4EPM9Z6</b>	829 €	829 €	829 €
<b>UN'ANTA A SPECCHIO CON SCHIENA A SPECCHIO</b>							
72	90	45X2	-	<b>L4EPP9Z6</b>	983 €	983 €	983 €

## “SLIDE” SPECCHI CONTENITORI STRUTTURA ALLUMINIO PROF. 14 CM CON KIT LUCE

Il KIT LUCE COMPRENDE: illuminazione led interna, 1 presa shuko, 1 interruttore a sfioramento ON/OFF + dimmer

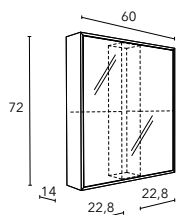

un'anta a specchio

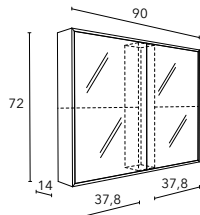

due ante a specchio

Misure				Codice	Prezzo		
Altezza	Largh. Specchio	Largh. Anta	U		B	H	
					Bianco	Silver	Nero
<b>UN'ANTA A SPECCHIO SENZA SCHIENA</b>							
72	60	60	Cerniere a destra	<b>D4EPN8S6</b>	850 €	850 €	850 €
72	60	60	Cerniere a sinistra	<b>S4EPN8S6</b>	850 €	850 €	850 €
<b>UN'ANTA A SPECCHIO CON SCHIENA A SPECCHIO</b>							
72	60	60	Cerniere a destra	<b>D4EPQ8S6</b>	986 €	986 €	986 €
72	60	60	Cerniere a sinistra	<b>S4EPQ8S6</b>	986 €	986 €	986 €
<b>DUE ANTE A SPECCHIO SENZA SCHIENA</b>							
72	90	45X2	-	<b>L4EPN9Z6</b>	992 €	992 €	992 €
<b>DUE ANTE A SPECCHIO CON SCHIENA A SPECCHIO</b>							
72	90	45X2	-	<b>L4EPQ9Z6</b>	1.162 €	1.162 €	1.162 €



A richiesta 2 ripiani a vetro interni: maggiorazione € 50  
A richiesta predisposizione per lampada superiore con interruttore interno: maggiorazione € 20  
Optional: KIT SOUND BLUETOOTH da inserire solo su specchi contenitori con kit luce € 250



**“SLIDE” SPECCHI CONTENITORI  
STRUTTURA ALLUMINIO PROF. 14 CM  
SENZA ILLUMINAZIONE**

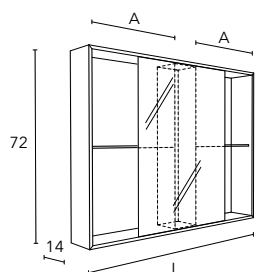

**A Vano Utile**  
(90) (120) (150) (180)  
**38,4 53,4 68,4 83,4**

Misure			Codice	Prezzo		
Altezza	Largh. Specchio	Largh. Anta		U	B	H
				Bianco	Silver	Nero
<b>SENZA SCHIENA</b>						
72	90	51	<b>L4EPMRZ6</b>	780 €	780 €	780 €
72	120	66	<b>L4EPMRQ6</b>	810 €	810 €	810 €
72	150	81	<b>L4EPMRW6</b>	845 €	845 €	845 €
72	180	96	<b>L4EPMRY6</b>	880 €	880 €	880 €
<b>CON SCHIENA A SPECCHIO</b>						
72	90	51	<b>L4EPPRZ6</b>	845 €	845 €	845 €
72	120	66	<b>L4EPPRQ6</b>	891 €	891 €	891 €
72	150	81	<b>L4EPPRW6</b>	942 €	942 €	942 €
72	180	96	<b>L4EPPRY6</b>	1.080 €	1.080 €	1.080 €

**“SLIDE” SPECCHI CONTENITORI  
STRUTTURA ALLUMINIO PROF. 14 CM  
CON KIT LUCE**

Il KIT LUCE COMPRENDE: illuminazione led interna, 1 presa shuko, 1 interruttore a sfioramento ON/OFF + dimmer

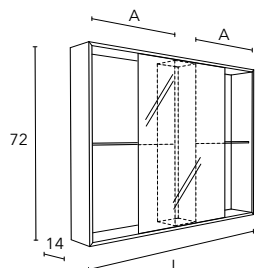

**A Vano Utile**  
(90) (120) (150) (180)  
**38,4 53,4 68,4 83,4**

Misure			Codice	Prezzo		
Altezza	Largh. Specchio	Largh. Anta		U	B	H
				Bianco	Silver	Nero
<b>SENZA SCHIENA</b>						
72	90	51	<b>L4EPNRZ6</b>	940 €	940 €	940 €
72	120	66	<b>L4EPNRQ6</b>	970 €	970 €	970 €
72	150	81	<b>L4EPNRW6</b>	1.005 €	1.005 €	1.005 €
72	180	96	<b>L4EPNRY6</b>	1.040 €	1.040 €	1.040 €
<b>CON SCHIENA A SPECCHIO</b>						
72	90	51	<b>L4EPQRZ6</b>	1.005 €	1.005 €	1.005 €
72	120	66	<b>L4EPQRQ6</b>	1.051 €	1.051 €	1.051 €
72	150	81	<b>L4EPQRW6</b>	1.102 €	1.102 €	1.102 €
72	180	96	<b>L4EPQRY6</b>	1.240 €	1.240 €	1.240 €



A richiesta 2 ripiani a vetro interni: maggiorazione € 50  
A richiesta predisposizione per lampada superiore con interruttore interno: maggiorazione € 20  
Optional: KIT SOUND BLUETOOTH da inserire solo su specchi contenitori con kit luce € 250

# ACCESSORI **FRAME**

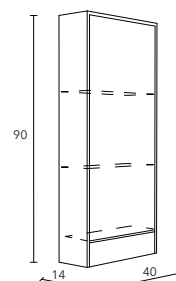

un'anta

## PENSILE PROF. 14 CM

Misure				Anta					Struttura		
				Finitura Anta					Scelta Profilo		
				<b>00</b>	<b>U</b>	<b>R</b>	<b>O</b>	<b>S</b>	<b>U</b>	<b>B</b>	<b>H</b>
				Specchio	Bianco Morbido	Cenere	Polvere	Tortora	Bianco	Silver	Nero
<b>SENZA SCHIENA</b>											
40	40	Cerniere a destra	<b>D4EPZ1D7</b>	486 €	553 €	626 €	626 €	626 €			
<b>CON SCHIENA A SPECCHIO</b>											
40	40	Cerniere a destra	<b>S4EPZ1D7</b>	486 €	553 €	626 €	626 €	626 €			



**“SLIDE” SPECCHI CONTENITORI VERTICALI CON ANTA INTERA A SPECCHIO PROF. 18 CM**

Misure		Codice	Scelta finitura									Scelta colore profilo		
Altezza	Larghezza		A	U	I	N	M	X	R	O	S	U	B	H
58	45	Cerniere a destra <b>D4EPD6JN</b>	Bianco lucido 583 €	Bianco Morbido 583 €	Bianco rigato 583 €	Burlington 583 €	Grain 583 €	Dolomite 583 €	Cenere 650 €	Polvere 650 €	Tortora 650 €	Bianco Morbido	Silver	Nero
58	45	Cerniere a sinistra <b>S4EPD6JN</b>	583 €	583 €	583 €	583 €	583 €	583 €	650 €	650 €	650 €			
82	45	Cerniere a destra <b>D4EPD6J6</b>	635 €	635 €	635 €	635 €	635 €	635 €	714 €	714 €	714 €			
82	45	Cerniere a sinistra <b>S4EPD6J6</b>	635 €	635 €	635 €	635 €	635 €	635 €	714 €	714 €	714 €			
94	45	Cerniere a destra <b>D4EPD6J8</b>	703 €	703 €	703 €	703 €	703 €	703 €	788 €	788 €	788 €			
94	45	Cerniere a sinistra <b>S4EPD6J8</b>	703 €	703 €	703 €	703 €	703 €	703 €	788 €	788 €	788 €			
130	45	Cerniere a destra <b>D4EPD6JC</b>	806 €	806 €	806 €	806 €	806 €	806 €	903 €	903 €	903 €			
130	45	Cerniere a sinistra <b>S4EPD6JC</b>	806 €	806 €	806 €	806 €	806 €	806 €	903 €	903 €	903 €			

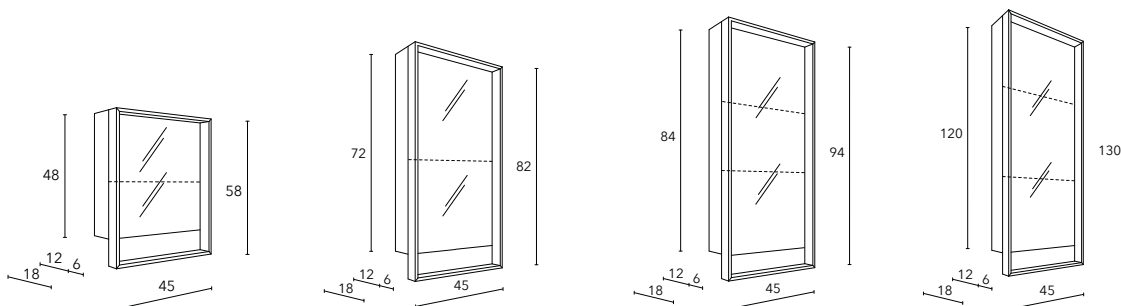

## ACCESSORI **FRAME**



### SPECCHI RETROILLUMINATI TRE LATI LUCE LED (no lato inferiore)

Lo specchio può essere posizionato in VERTICALE. Specificare al momento dell'ordine.

#### Altezza 52 cm

Altezza	Larghezza	Codice	Prezzo
52	60	<b>L4ESA16000</b>	334 €
52	70	<b>L4ESA17000</b>	340 €
52	80	<b>L4ESA18000</b>	347 €
52	90	<b>L4ESA19000</b>	353 €
52	100	<b>L4ESA1A100</b>	394 €
52	105	<b>L4ESA1A600</b>	428 €
52	110	<b>L4ESA1B200</b>	431 €
52	120	<b>L4ESA1C300</b>	438 €
52	130	<b>L4ESA1D400</b>	442 €
52	140	<b>L4ESA1E500</b>	446 €
52	150	<b>L4ESA1F600</b>	451 €
52	160	<b>L4ESA1G700</b>	456 €
52	170	<b>L4ESA1H800</b>	461 €
52	180	<b>L4ESA1J900</b>	465 €

#### Altezza 72 cm

Altezza	Larghezza	Codice	Prezzo
72	60	<b>L4ESA26000</b>	343 €
72	70	<b>L4ESA27000</b>	352 €
72	80	<b>L4ESA28000</b>	402 €
72	90	<b>L4ESA29000</b>	434 €
72	100	<b>L4ESA2A100</b>	440 €
72	105	<b>L4ESA2A600</b>	444 €
72	110	<b>L4ESA2B200</b>	446 €
72	120	<b>L4ESA2C300</b>	455 €
72	130	<b>L4ESA2D400</b>	463 €
72	140	<b>L4ESA2E500</b>	494 €
72	150	<b>L4ESA2F600</b>	505 €
72	160	<b>L4ESA2G700</b>	522 €
72	170	<b>L4ESA2H800</b>	540 €
72	180	<b>L4ESA2J900</b>	558 €

#### Altezza 84 cm

Altezza	Larghezza	Codice	Prezzo
84	60	<b>L4ESA36000</b>	352 €
84	70	<b>L4ESA37000</b>	401 €
84	80	<b>L4ESA38000</b>	435 €
84	90	<b>L4ESA39000</b>	443 €
84	100	<b>L4ESA3A100</b>	449 €
84	105	<b>L4ESA3A600</b>	452 €
84	110	<b>L4ESA3B200</b>	457 €
84	120	<b>L4ESA3C300</b>	466 €
84	130	<b>L4ESA3D400</b>	499 €
84	140	<b>L4ESA3E500</b>	506 €
84	150	<b>L4ESA3F600</b>	522 €
84	160	<b>L4ESA3G700</b>	540 €
84	170	<b>L4ESA3H800</b>	558 €
84	180	<b>L4ESA3J900</b>	574 €

\* Prezzo specchio fuori misura in Larghezza: fare riferimento alla misura inferiore e applicare una maggiorazione del 25%. Larghezza massima 200 cm.





SPECCHI RETROILLUMINATI TRE LATI LUCE LED CON MENSOLA INFERIORE IN ALLUMINIO PROF.14 CM

Altezza 52 cm

Larghezza	Codice	Scelta Profilo		
		U	B	H
		Bianco opaco	Silver	Nero opaco
60	<b>L4ESB16000</b>	437 €	437 €	437 €
70	<b>L4ESB17000</b>	447 €	447 €	447 €
80	<b>L4ESB18000</b>	460 €	460 €	460 €
90	<b>L4ESB19000</b>	470 €	470 €	470 €
100	<b>L4ESB1A100</b>	510 €	510 €	510 €
105	<b>L4ESB1A600</b>	552 €	552 €	552 €
110	<b>L4ESB1B200</b>	557 €	557 €	557 €
120	<b>L4ESB1C300</b>	570 €	570 €	570 €
130	<b>L4ESB1D400</b>	577 €	577 €	577 €
140	<b>L4ESB1E500</b>	586 €	586 €	586 €
150	<b>L4ESB1F600</b>	595 €	595 €	595 €
160	<b>L4ESB1G700</b>	604 €	604 €	604 €
170	<b>L4ESB1H800</b>	613 €	613 €	613 €
180	<b>L4ESB1J900</b>	622 €	622 €	622 €

Altezza 72 cm

Codice	Scelta Profilo		
	U	B	H
	Bianco opaco	Silver	Nero opaco
<b>L4ESB26000</b>	446 €	446 €	446 €
<b>L4ESB27000</b>	459 €	459 €	459 €
<b>L4ESB28000</b>	514 €	514 €	514 €
<b>L4ESB29000</b>	551 €	551 €	551 €
<b>L4ESB2A100</b>	560 €	560 €	560 €
<b>L4ESB2A600</b>	569 €	569 €	569 €
<b>L4ESB2B200</b>	573 €	573 €	573 €
<b>L4ESB2C300</b>	586 €	586 €	586 €
<b>L4ESB2D400</b>	599 €	599 €	599 €
<b>L4ESB2E500</b>	637 €	637 €	637 €
<b>L4ESB2F600</b>	645 €	645 €	645 €
<b>L4ESB2G700</b>	662 €	662 €	662 €
<b>L4ESB2H800</b>	680 €	680 €	680 €
<b>L4ESB2J900</b>	700 €	700 €	700 €

Altezza 84 cm

Codice	Scelta Profilo		
	U	B	H
	Bianco opaco	Silver	Nero opaco
<b>L4ESB36000</b>	453 €	453 €	453 €
<b>L4ESB37000</b>	509 €	509 €	509 €
<b>L4ESB38000</b>	548 €	548 €	548 €
<b>L4ESB39000</b>	561 €	561 €	561 €
<b>L4ESB3A100</b>	569 €	569 €	569 €
<b>L4ESB3A600</b>	577 €	577 €	577 €
<b>L4ESB3B200</b>	583 €	583 €	583 €
<b>L4ESB3C300</b>	598 €	598 €	598 €
<b>L4ESB3D400</b>	636 €	636 €	636 €
<b>L4ESB3E500</b>	649 €	649 €	649 €
<b>L4ESB3F600</b>	661 €	661 €	661 €
<b>L4ESB3G700</b>	676 €	676 €	676 €
<b>L4ESB3H800</b>	693 €	693 €	693 €
<b>L4ESB3J900</b>	719 €	719 €	719 €

# ACCESSORI **FRAME**



**SPECCHI CON MENSOLA IN ALLUMINIO PROF. 14 CM, LED INTEGRATO**

## Altezza 52 cm

Larghezza	Codice	Scelta Profilo		
		U	B	H
		Bianco opaco	Silver	Nero opaco
60	<b>L4ESF16000</b>	227 €	227 €	227 €
70	<b>L4ESF17000</b>	243 €	243 €	243 €
80	<b>L4ESF18000</b>	259 €	259 €	259 €
90	<b>L4ESF19000</b>	274 €	274 €	274 €
100	<b>L4ESF1A100</b>	289 €	289 €	289 €
105	<b>L4ESF1A600</b>	297 €	297 €	297 €
110	<b>L4ESF1B200</b>	305 €	305 €	305 €
120	<b>L4ESF1C300</b>	317 €	317 €	317 €
130	<b>L4ESF1D400</b>	337 €	337 €	337 €
140	<b>L4ESF1E500</b>	356 €	356 €	356 €
150	<b>L4ESF1F600</b>	370 €	370 €	370 €
160	<b>L4ESF1G700</b>	385 €	385 €	385 €
170	<b>L4ESF1H800</b>	399 €	399 €	399 €
180	<b>L4ESF1J900</b>	414 €	414 €	414 €

## Altezza 72 cm

Codice	Scelta Profilo		
	U	B	H
	Bianco opaco	Silver	Nero opaco
<b>L4ESF26000</b>	263 €	263 €	263 €
<b>L4ESF27000</b>	284 €	284 €	284 €
<b>L4ESF28000</b>	305 €	305 €	305 €
<b>L4ESF29000</b>	326 €	326 €	326 €
<b>L4ESF2A100</b>	345 €	345 €	345 €
<b>L4ESF2A600</b>	356 €	356 €	356 €
<b>L4ESF2B200</b>	366 €	366 €	366 €
<b>L4ESF2C300</b>	384 €	384 €	384 €
<b>L4ESF2D400</b>	413 €	413 €	413 €
<b>L4ESF2E500</b>	443 €	443 €	443 €
<b>L4ESF2F600</b>	467 €	467 €	467 €
<b>L4ESF2G700</b>	492 €	492 €	492 €
<b>L4ESF2H800</b>	516 €	516 €	516 €
<b>L4ESF2J900</b>	540 €	540 €	540 €

## Altezza 84 cm

Codice	Scelta Profilo		
	U	B	H
	Bianco opaco	Silver	Nero opaco
<b>L4ESF36000</b>	280 €	280 €	280 €
<b>L4ESF37000</b>	301 €	301 €	301 €
<b>L4ESF38000</b>	324 €	324 €	324 €
<b>L4ESF39000</b>	345 €	345 €	345 €
<b>L4ESF3A100</b>	365 €	365 €	365 €
<b>L4ESF3A600</b>	377 €	377 €	377 €
<b>L4ESF3B200</b>	388 €	388 €	388 €
<b>L4ESF3C300</b>	406 €	406 €	406 €
<b>L4ESF3D400</b>	431 €	431 €	431 €
<b>L4ESF3E500</b>	457 €	457 €	457 €
<b>L4ESF3F600</b>	477 €	477 €	477 €
<b>L4ESF3G700</b>	497 €	497 €	497 €
<b>L4ESF3H800</b>	518 €	518 €	518 €
<b>L4ESF3J900</b>	538 €	538 €	538 €



SPECCHI CON MENSOLE IN ALLUMINIO PROF. 14 CM, LED INTEGRATO NELLA MENSOLA SUPERIORE

Altezza 52 cm

Larghezza	Codice	Scelta Profilo		
		U	B	H
		Bianco opaco	Silver	Nero opaco
60	<b>L4ES816000</b>	398 €	398 €	398 €
70	<b>L4ES817000</b>	418 €	418 €	418 €
80	<b>L4ES818000</b>	439 €	439 €	439 €
90	<b>L4ES819000</b>	466 €	466 €	466 €
100	<b>L4ES81A100</b>	487 €	487 €	487 €
105	<b>L4ES81A600</b>	504 €	504 €	504 €
110	<b>L4ES81B200</b>	513 €	513 €	513 €
120	<b>L4ES81C300</b>	540 €	540 €	540 €
130	<b>L4ES81D400</b>	556 €	556 €	556 €
140	<b>L4ES81E500</b>	<b>574 €</b>	574 €	574 €
150	<b>L4ES81F600</b>	586 €	586 €	586 €
160	<b>L4ES81G700</b>	599 €	599 €	599 €
170	<b>L4ES81H800</b>	615 €	615 €	615 €
180	<b>L4ES81J900</b>	631 €	631 €	631 €

Altezza 72 cm

Codice	Scelta Profilo		
	U	B	H
	Bianco opaco	Silver	Nero opaco
<b>L4ES826000</b>	409 €	409 €	409 €
<b>L4ES827000</b>	438 €	438 €	438 €
<b>L4ES828000</b>	466 €	466 €	466 €
<b>L4ES829000</b>	494 €	494 €	494 €
<b>L4ES82A100</b>	513 €	513 €	513 €
<b>L4ES82A600</b>	539 €	539 €	539 €
<b>L4ES82B200</b>	556 €	556 €	556 €
<b>L4ES82C300</b>	584 €	584 €	584 €
<b>L4ES82D400</b>	612 €	612 €	612 €
<b>L4ES82E500</b>	641 €	641 €	641 €
<b>L4ES82F600</b>	652 €	652 €	652 €
<b>L4ES82G700</b>	668 €	668 €	668 €
<b>L4ES82H800</b>	690 €	690 €	690 €
<b>L4ES82J900</b>	712 €	712 €	712 €

Altezza 84 cm

Codice	Scelta Profilo		
	U	B	H
	Bianco opaco	Silver	Nero opaco
<b>L4ES836000</b>	415 €	415 €	415 €
<b>L4ES837000</b>	445 €	445 €	445 €
<b>L4ES838000</b>	473 €	473 €	473 €
<b>L4ES839000</b>	503 €	503 €	503 €
<b>L4ES83A100</b>	523 €	523 €	523 €
<b>L4ES83A600</b>	549 €	549 €	549 €
<b>L4ES83B200</b>	566 €	566 €	566 €
<b>L4ES83C300</b>	596 €	596 €	596 €
<b>L4ES83D400</b>	624 €	624 €	624 €
<b>L4ES83E500</b>	653 €	653 €	653 €
<b>L4ES83F600</b>	664 €	664 €	664 €
<b>L4ES83G700</b>	679 €	679 €	679 €
<b>L4ES83H800</b>	702 €	702 €	702 €
<b>L4ES83J900</b>	725 €	725 €	725 €

# ACCESSORI **FRAME**



**SPECCHI CON MENSOLA IN ALLUMINIO PROF. 14 CM, LED INTEGRATO NELLA MENSOLA SUPERIORE E MENSOLA INFERIORE ALLUNGATA DI 60 CM CON PORTA SALVIETTE**

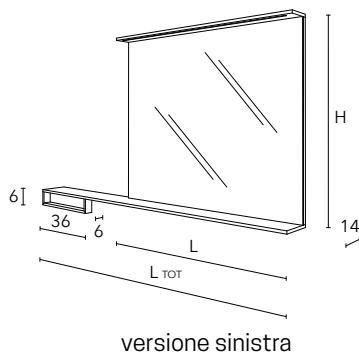
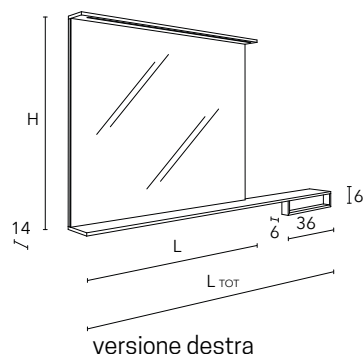

Misure			Codice	Destra	Sinistra	Scelta Profilo		
Altezza	Largh. Totale	Largh. Specchio				U	B	H
						Bianco opaco	Silver	Nero opaco
52	120	60	<b>SPEC101</b>	D	S	537 €	537 €	537 €
52	130	70	<b>SPEC102</b>	D	S	558 €	558 €	558 €
52	140	80	<b>SPEC103</b>	D	S	582 €	582 €	582 €
52	150	90	<b>SPEC104</b>	D	S	610 €	610 €	610 €
52	165	105	<b>SPEC105</b>	D	S	647 €	647 €	647 €
52	170	110	<b>SPEC106</b>	D	S	657 €	657 €	657 €
52	180	120	<b>SPEC107</b>	D	S	687 €	687 €	687 €
52	190	130	<b>SPEC108</b>	D	S	705 €	705 €	705 €
52	200	140	<b>SPEC109</b>	D	S	732 €	732 €	732 €
72	120	60	<b>SPEC201</b>	D	S	553 €	553 €	553 €
72	130	70	<b>SPEC202</b>	D	S	583 €	583 €	583 €
72	140	80	<b>SPEC203</b>	D	S	612 €	612 €	612 €
72	150	90	<b>SPEC204</b>	D	S	642 €	642 €	642 €
72	165	105	<b>SPEC205</b>	D	S	686 €	686 €	686 €
72	170	110	<b>SPEC206</b>	D	S	707 €	707 €	707 €
72	180	120	<b>SPEC207</b>	D	S	736 €	736 €	736 €
72	190	130	<b>SPEC208</b>	D	S	759 €	759 €	759 €
72	200	140	<b>SPEC209</b>	D	S	782 €	782 €	782 €
84	120	60	<b>SPEC301</b>	D	S	562 €	562 €	562 €
84	130	70	<b>SPEC302</b>	D	S	590 €	590 €	590 €
84	140	80	<b>SPEC303</b>	D	S	621 €	621 €	621 €
84	150	90	<b>SPEC304</b>	D	S	650 €	650 €	650 €
84	165	105	<b>SPEC305</b>	D	S	695 €	695 €	695 €
84	170	110	<b>SPEC306</b>	D	S	716 €	716 €	716 €
84	180	120	<b>SPEC307</b>	D	S	747 €	747 €	747 €
84	190	130	<b>SPEC308</b>	D	S	778 €	778 €	778 €
84	200	140	<b>SPEC309</b>	D	S	807 €	807 €	807 €



## BOISERIE PROF. 12 CM CON ELEMENTI IN ALLUMINIO

Misure			Codice	Scelta finitura									Scelta colore profilo		
Larghezza	Altezza	Profondità		A	U	I	N	M	X	R	O	S	U	B	H
				Bianco lucido	Bianco Morbido	Bianco rigato	Burlington	Grain	Dolomite	Cenere	Polvere	Tortora	Bianco Morbido	Silver	Nero

### DUE MENSOLE

Versione destra	60	24	12	<b>D4EV97E5</b>	358 €	358 €	358 €	358 €	358 €	358 €	388 €	388 €	388 €			
Versione sinistra	60	24	12	<b>S4EV97E5</b>	358 €	358 €	358 €	358 €	358 €	358 €	388 €	388 €	388 €			

### UNA MENSOLA, UN PORTA SALVIETTE

Versione destra	60	24	12	<b>D4EV98E5</b>	384 €	384 €	384 €	384 €	384 €	384 €	414 €	414 €	414 €			
Versione sinistra	60	24	12	<b>S4EV98E5</b>	384 €	384 €	384 €	384 €	384 €	384 €	414 €	414 €	414 €			

### UNA MENSOLA, PORTA SALVIETTE CROMO

Versione destra	60	24	12	<b>D4EV99E5</b>	348 €	348 €	348 €	348 €	348 €	348 €	379 €	379 €	379 €			
Versione sinistra	60	24	12	<b>S4EV99E5</b>	348 €	348 €	348 €	348 €	348 €	348 €	379 €	379 €	379 €			

### DUE MENSOLE

Versione destra	60	24	12	<b>D4EV9AE5</b>	388 €	388 €	388 €	388 €	388 €	388 €	418 €	418 €	418 €			
Versione sinistra	60	24	12	<b>S4EV9AE5</b>	388 €	388 €	388 €	388 €	388 €	388 €	418 €	418 €	418 €			

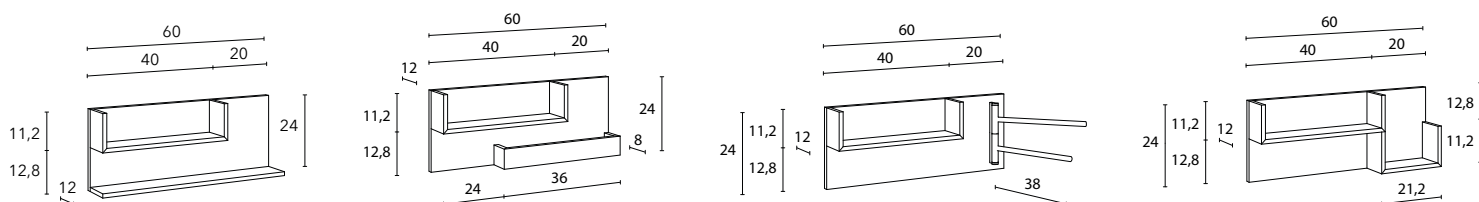

# ACCESSORI FRAME



## BOISERIE PROF. 12 CM CON ELEMENTI IN ALLUMINIO

Misure			Codice	Scelta finitura										Scelta colore profilo		
Larghezza	Altezza	Profondità		A	U	I	N	M	X	R	O	S	U	B	H	
				Bianco lucido	Bianco Morbido	Bianco rigato	Burlington	Grain	Dolomite	Cenere	Polvere	Tortora	Bianco Morbido	Silver	Nero	
<b>UNA MENSOLA</b>																
Versione destra	100	24	12	<b>D4EV91A1</b>	359 €	359 €	359 €	359 €	359 €	359 €	401 €	401 €	401 €			
Versione sinistra	100	24	12	<b>S4EV91A1</b>	359 €	359 €	359 €	359 €	359 €	359 €	401 €	401 €	401 €			
Versione destra	120	24	12	<b>D4EV91C3</b>	382 €	382 €	382 €	382 €	382 €	382 €	434 €	434 €	434 €			
Versione sinistra	120	24	12	<b>S4EV91C3</b>	382 €	382 €	382 €	382 €	382 €	382 €	434 €	434 €	434 €			
Versione destra	140	24	12	<b>D4EV91E5</b>	401 €	401 €	401 €	401 €	401 €	401 €	463 €	463 €	463 €			
Versione sinistra	140	24	12	<b>S4EV91E5</b>	401 €	401 €	401 €	401 €	401 €	401 €	463 €	463 €	463 €			
<b>UNA MENSOLA, DUE FORI Ø 6CM PORTA BICCHIERI</b>																
Versione destra	100	24	12	<b>D4EV93A1</b>	368 €	368 €	368 €	368 €	368 €	368 €	411 €	411 €	411 €			
Versione sinistra	100	24	12	<b>S4EV93A1</b>	368 €	368 €	368 €	368 €	368 €	368 €	411 €	411 €	411 €			
Versione destra	120	24	12	<b>D4EV93C3</b>	389 €	389 €	389 €	389 €	389 €	389 €	441 €	441 €	441 €			
Versione sinistra	120	24	12	<b>S4EV93C3</b>	389 €	389 €	389 €	389 €	389 €	389 €	441 €	441 €	441 €			
Versione destra	140	24	12	<b>D4EV93E5</b>	411 €	411 €	411 €	411 €	411 €	411 €	472 €	472 €	472 €			
Versione sinistra	140	24	12	<b>S4EV93E5</b>	411 €	411 €	411 €	411 €	411 €	411 €	472 €	472 €	472 €			
<b>UNA MENSOLA, PORTA SALVIETTE</b>																
Versione destra	100	24	12	<b>D4EV96A1</b>	438 €	438 €	438 €	438 €	438 €	438 €	480 €	480 €	480 €			
Versione sinistra	100	24	12	<b>S4EV96A1</b>	438 €	438 €	438 €	438 €	438 €	438 €	480 €	480 €	480 €			
Versione destra	120	24	12	<b>D4EV96C3</b>	459 €	459 €	459 €	459 €	459 €	459 €	511 €	511 €	511 €			
Versione sinistra	120	24	12	<b>S4EV96C3</b>	459 €	459 €	459 €	459 €	459 €	459 €	511 €	511 €	511 €			
Versione destra	140	24	12	<b>D4EV96E5</b>	480 €	480 €	480 €	480 €	480 €	480 €	542 €	542 €	542 €			
Versione sinistra	140	24	12	<b>S4EV96E5</b>	480 €	480 €	480 €	480 €	480 €	480 €	542 €	542 €	542 €			

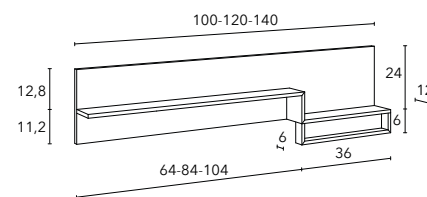
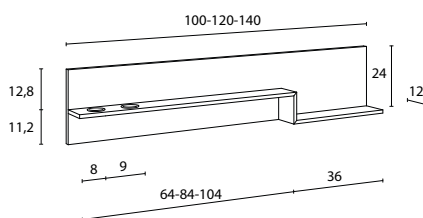
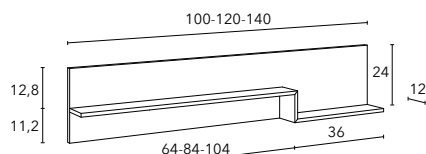



## BOISERIE PROF. 12 CM CON ELEMENTI IN ALLUMINIO

Misure			Codice	Scelta finitura									Scelta colore profilo		
Larghezza	Altezza	Profondità		A	U	I	N	M	X	R	O	S	U	B	H
				Bianco lucido	Bianco Morbido	Bianco rigato	Burlington	Grain	Dolomite	Cenere	Polvere	Tortora	Bianco Morbido	Silver	Nero

### UNA MENSOLA, DUE FORI Ø 6CM PORTA BICCHIERI, PORTA SALVIETTE

Versione destra	100	24	12	<b>D4EV92A1</b>	447 €	447 €	447 €	447 €	447 €	447 €	491 €	491 €	491 €			
Versione sinistra	100	24	12	<b>S4EV92A1</b>	447 €	447 €	447 €	447 €	447 €	447 €	491 €	491 €	491 €			
Versione destra	120	24	12	<b>D4EV92C3</b>	472 €	472 €	472 €	472 €	472 €	472 €	523 €	523 €	523 €			
Versione sinistra	120	24	12	<b>S4EV92C3</b>	472 €	472 €	472 €	472 €	472 €	472 €	523 €	523 €	523 €			
Versione destra	140	24	12	<b>D4EV92E5</b>	491 €	491 €	491 €	491 €	491 €	491 €	551 €	551 €	551 €			
Versione sinistra	140	24	12	<b>S4EV92E5</b>	491 €	491 €	491 €	491 €	491 €	491 €	551 €	551 €	551 €			

### UNA MENSOLA, UN FORO Ø 8CM PORTA PHON

Versione destra	100	24	12	<b>D4EV95A1</b>	363 €	363 €	363 €	363 €	363 €	363 €	406 €	406 €	406 €			
Versione sinistra	100	24	12	<b>S4EV95A1</b>	363 €	363 €	363 €	363 €	363 €	363 €	406 €	406 €	406 €			
Versione destra	120	24	12	<b>D4EV95C3</b>	384 €	384 €	384 €	384 €	384 €	384 €	437 €	437 €	437 €			
Versione sinistra	120	24	12	<b>S4EV95C3</b>	384 €	384 €	384 €	384 €	384 €	384 €	437 €	437 €	437 €			
Versione destra	140	24	12	<b>D4EV95E5</b>	406 €	406 €	406 €	406 €	406 €	406 €	467 €	467 €	467 €			
Versione sinistra	140	24	12	<b>S4EV95E5</b>	406 €	406 €	406 €	406 €	406 €	406 €	467 €	467 €	467 €			

### UNA MENSOLA, DUE FORI Ø 6CM PORTA BICCHIERI, PORTA SALVIETTE, UN FORO Ø 8CM PORTA PHON

Versione destra	100	24	12	<b>D4EV94A1</b>	373 €	373 €	373 €	373 €	373 €	373 €	415 €	415 €	415 €			
Versione sinistra	100	24	12	<b>S4EV94A1</b>	373 €	373 €	373 €	373 €	373 €	373 €	415 €	415 €	415 €			
Versione destra	120	24	12	<b>D4EV94C3</b>	394 €	394 €	394 €	394 €	394 €	394 €	446 €	446 €	446 €			
Versione sinistra	120	24	12	<b>S4EV94C3</b>	394 €	394 €	394 €	394 €	394 €	394 €	446 €	446 €	446 €			
Versione destra	140	24	12	<b>D4EV94E5</b>	415 €	415 €	415 €	415 €	415 €	415 €	477 €	477 €	477 €			
Versione sinistra	140	24	12	<b>S4EV94E5</b>	415 €	415 €	415 €	415 €	415 €	415 €	477 €	477 €	477 €			

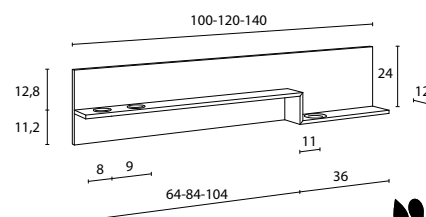
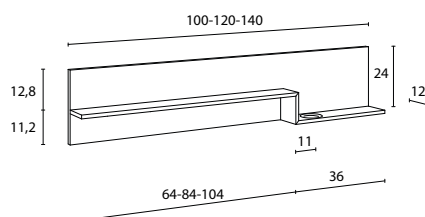
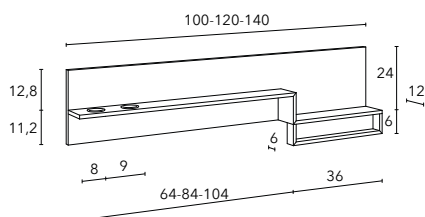

# RUBINETTERIA SERIE D - Abbinato a serie Divina



## MISCELATORE MONOCOMANDO PER LAVABO versione alta

Allacci idraulici	Codice	Finitura	Prezzo
1/2"	<b>RUBDLAHH-K</b>	Cromo	362 €
1/2"	<b>RUBDLAHH-H</b>	Nero	488 €

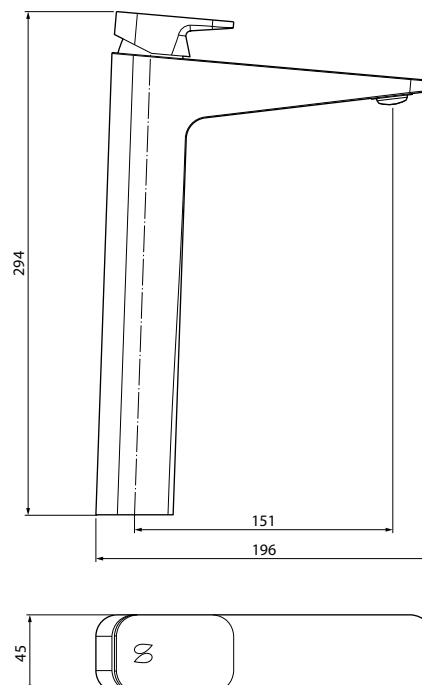

Piletta Click-Clack compresa nel prezzo





**MISCELATORE MONOCOMANDO PER LAVABO**  
versione bassa

Allacci idraulici	Codice	Finitura	Prezzo
1/2"	<b>RUBDLAHL-K</b>	Cromo	304 €
1/2"	<b>RUBDLAHL-H</b>	Nero	413 €

Piletta standard compresa nel prezzo

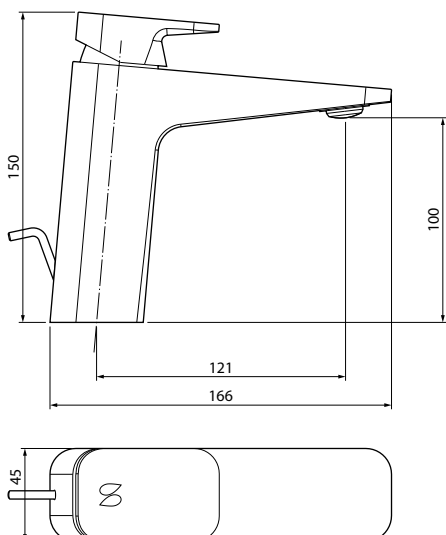

**MISCELATORE MONOCOMANDO PER BIDET**

Allacci idraulici	Codice	Finitura	Prezzo
1/2"	<b>RUBDBI-K</b>	Cromo	304 €
1/2"	<b>RUBDBI-H</b>	Nero	413 €

Piletta standard compresa nel prezzo

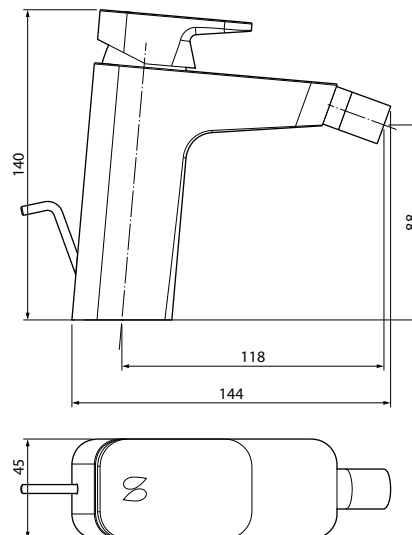

# RUBINETTERIA SERIE FLY 3

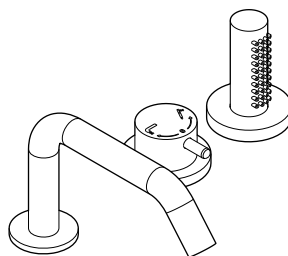

## RUBINETTERIA BORDO VASCA con miscelatore progressivo a 2 funzioni: rubinetteria bordo vasca, doccetta di servizio

Allacci idraulici	Codice	Finitura	Prezzo
1/2"	<b>RUBBVASY3-K</b>	Cromo	413 €
1/2"	<b>RUBBVASY3-28</b>	Nero opaco	562 €

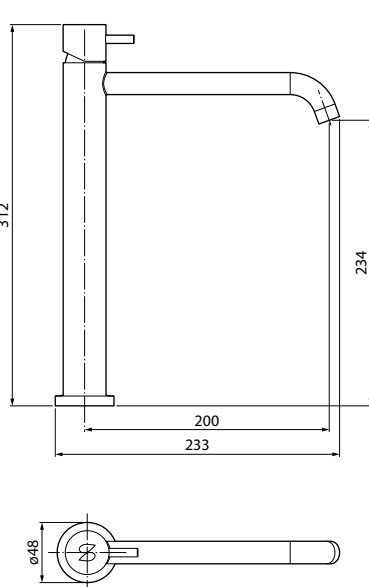
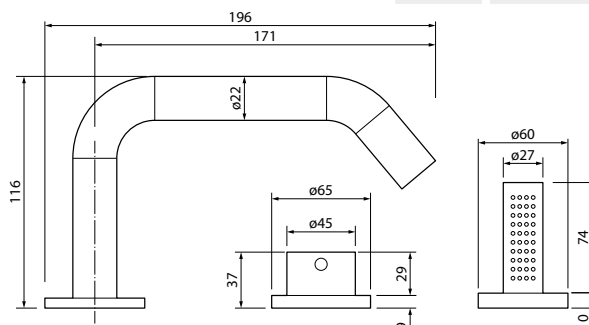

## MISCELATORE MONOCOMANDO PER LAVABO versione alta

Allacci idraulici	Codice	Finitura	Prezzo
1/2"	<b>RUBLAHHFY3-K</b>	Cromo	290 €
1/2"	<b>RUBLAHHFY3-28</b>	Nero opaco	394 €



Piletta Click-Clack compresa nel prezzo

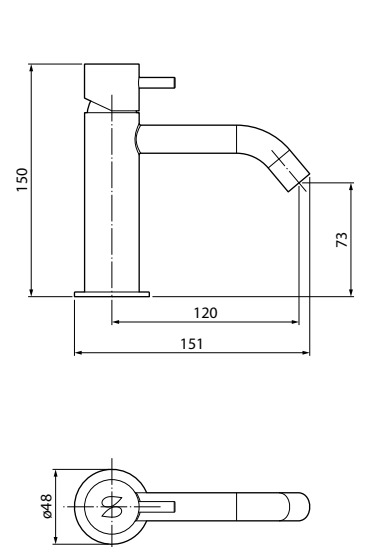

## MISCELATORE MONOCOMANDO PER LAVABO versione bassa

Allacci idraulici	Codice	Finitura	Prezzo
1/2"	<b>RUBLAHLFY3-K</b>	Cromo	239 €
1/2"	<b>RUBLAHLFY3-28</b>	Nero opaco	323 €



Piletta Click-Clack compresa nel prezzo

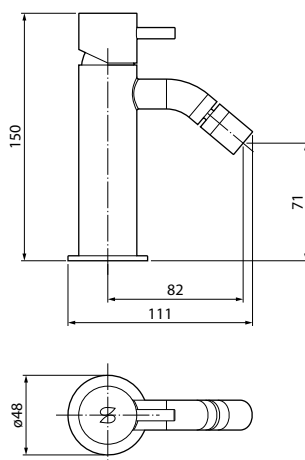

### MISCELATORE MONOCOMANDO PER BIDET

Allacci idraulici	Codice	Finitura	Prezzo
1/2"	<b>RUBBIFY3-K</b>	Cromo	239 €
1/2"	<b>RUBBIFY3-28</b>	Nero opaco	323 €



Piletta Click-Clack compresa nel prezzo

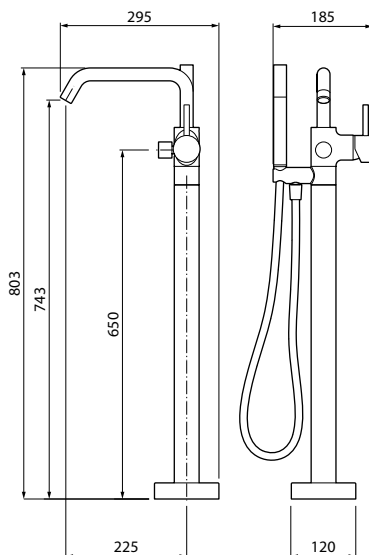

### PIANTANA DA TERRA

Finitura	Codice	Prezzo
Cromo	<b>RUBPVASRSN-K</b>	1.438 €
Nero opaco	<b>RUBPVASRSN-H</b>	1.688 €

# RUBINETTERIA SERIE FLY 2

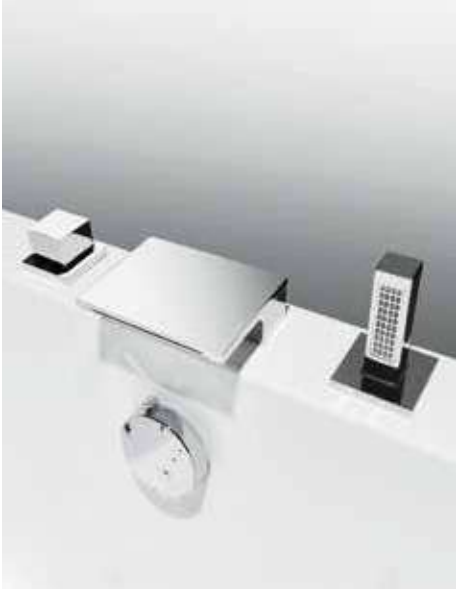

### RUBINETTERIA BORDO VASCA

con miscelatore progressivo a 2 funzioni:  
bocca a cascata di riempimento, doccia di servizio

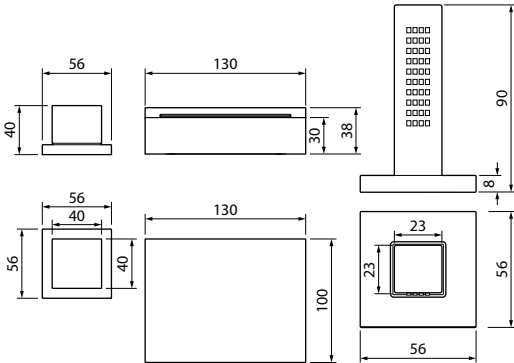
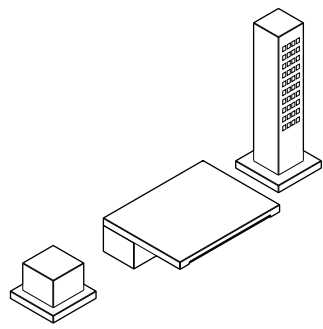
Allacci idraulici	Codice	Finitura	Prezzo
1/2"	<b>KRUBBVAQNO-K</b>	Cromo	593 €

Versione alta



Versione bassa



### MISCELATORE MONOCOMANDO PER LAVABO





Misure	Allacci idraulici	Codice	Finitura	Prezzo
Versione alta				
H 28,8 x 19,4 cm	1/2"	<b>RUBLA288NO-K</b>	Cromo	407 €
Versione basse				
H 15,5 x 15,3 cm	1/2"	<b>RUBLA151NO-K</b>	Cromo	349 €



Pilletta Click-Clack compresa nel prezzo

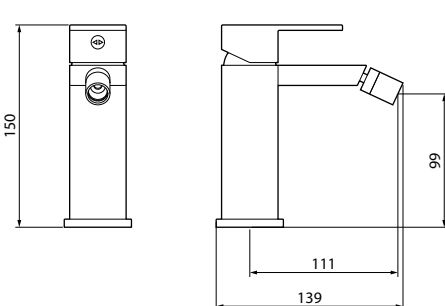

### MISCELATORE MONOCOMANDO PER BIDET





Pilletta Click-Clack compresa nel prezzo

Misure	Allacci idraulici	Codice	Finitura	Prezzo
H 15 x 13,9 cm	1/2"	<b>RUBBI151NO-K</b>	Cromo	323 €

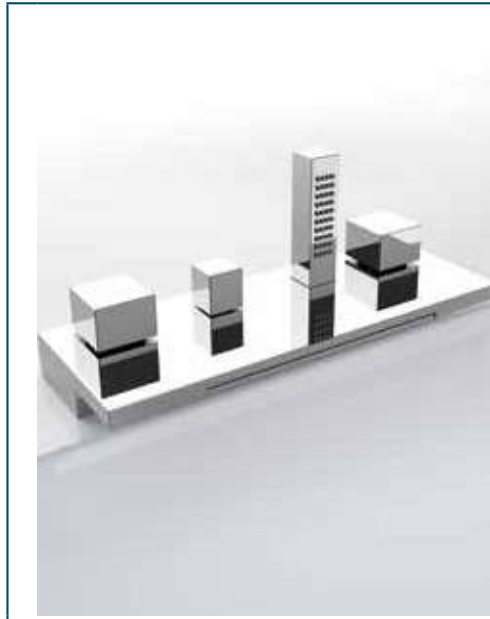
# RUBINETTERIA PER VASCHE

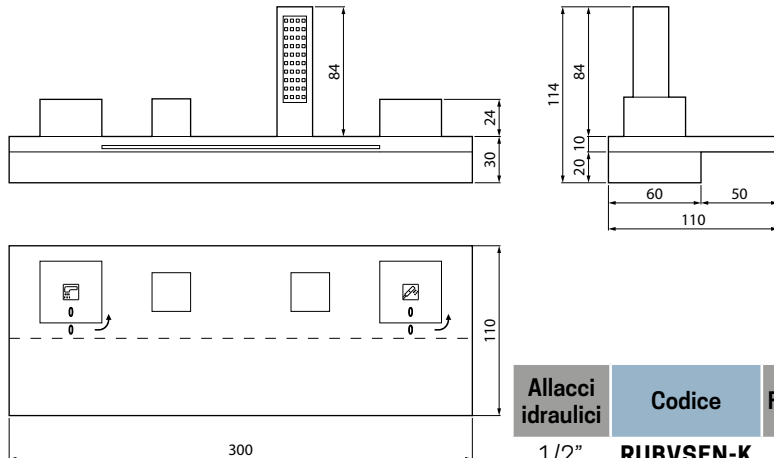

**RUBINETTERIA BORDO VASCA** (per Sense Dual, Sense 3, Sense 4)  
con 2 cartucce di miscelazione progressiva:  
bocca a cascata di riempimento, doccetta di servizio



Allacci idraulici	Codice	Finitura	Prezzo
1/2"	<b>RUBVSEN-K</b>	Cromo	1.030 €



**RUBINETTERIA BORDO VASCA** (per Stile)  
con cartuccia di miscelazione progressiva, doccetta di servizio  
design Marco Pellici

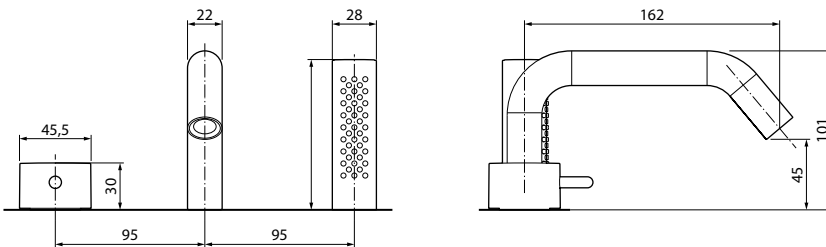

Allacci idraulici	Codice	Finitura	Prezzo
	<b>RUBVSTI-K</b>	Cromo	685 €
	<b>RUBVSTI-H</b>	Nero opaco	825 €



**SIFONE D'ARREDO**

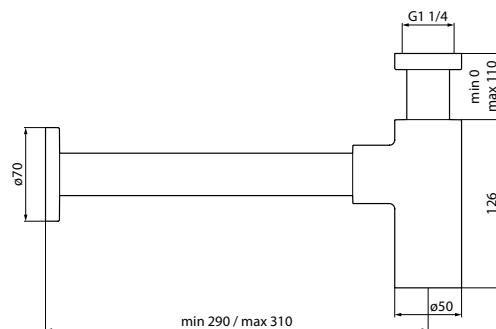

Allacci idraulici	Codice	Finitura	Prezzo
1/4"	<b>SIFRUBLAV-K</b>	Cromo	110 €
1/4"	<b>SIFRUBLAV-28</b>	Nero opaco	182 €



X 32 cm  
Y 44 cm  
Z 26 cm

## SEDILE IN ACRILICO OPALINO (Portata max 100 kg)

Codice	Prezzo
<b>SED030PL</b>	369 €

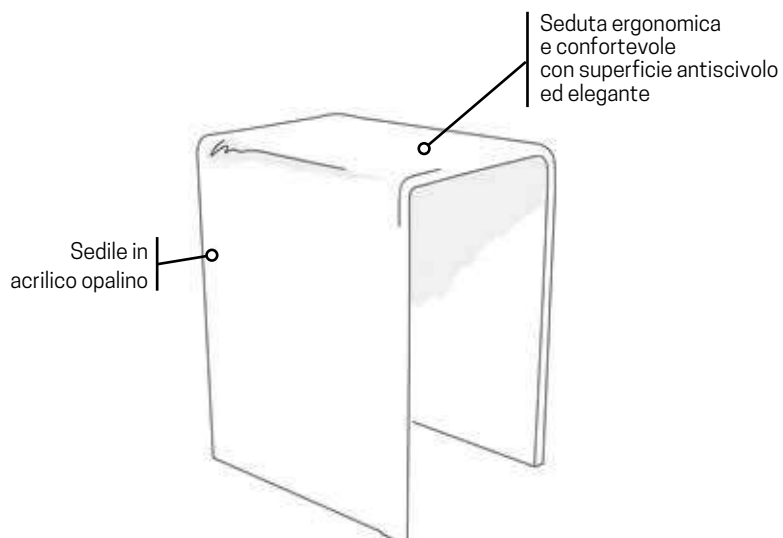

X 37 cm  
Y 37 cm  
Z 48 cm

## SGABELLO (Portata max 100 kg)

Sgabello nero RAL 7012 o bianco RAL 9003, con telaio in alluminio anodizzato

Finitura	Codice	Prezzo
Nero	<b>SED02Q-H</b>	565 €

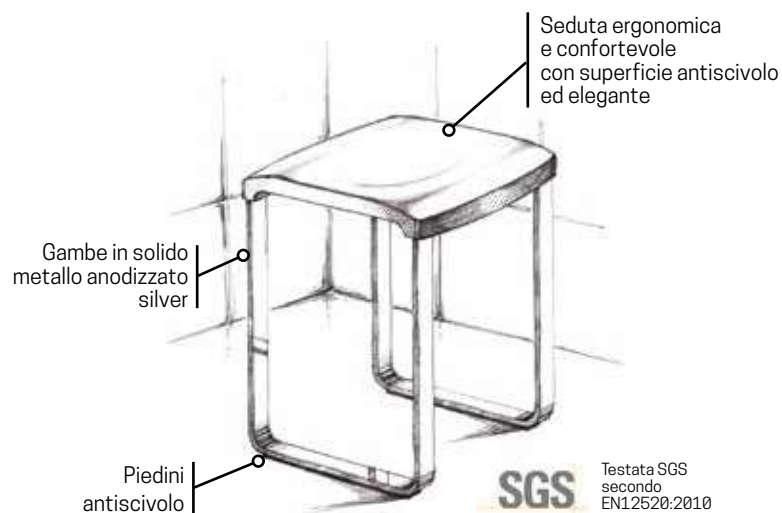

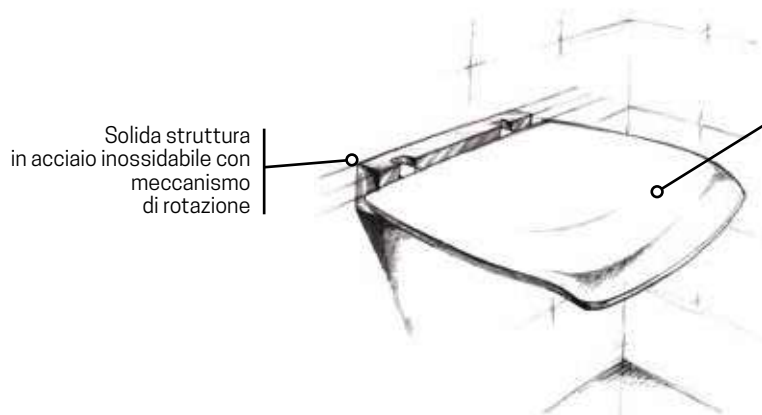

Solida struttura in acciaio inossidabile con meccanismo di rotazione

Seduta ergonomica e confortevole con superficie antiscivolo

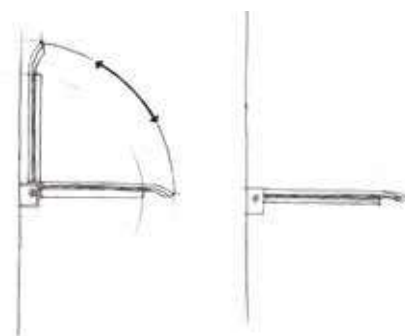

X 38 cm  
Y 7 cm  
Z 37 cm



X 33 cm  
Y 20 cm  
Z 27 cm

### SEDILE RECLINABILE (Portata max 100 kg)

Sedile reclinabile a parete nero RAL 7021 o bianco RAL 9003, con struttura in metallo cromato

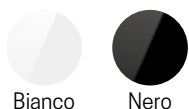

Bianco Nero

Finitura	Codice	Prezzo
Bianco	<b>SED02QFM-A</b>	373 €
Nero	<b>SED02QFM-H</b>	373 €

### SEDILE RECLINABILE TONDO IN EVA (Portata max 100 kg)

Sedile reclinabile a parete nero RAL 7021 o bianco RAL 9003, con struttura in metallo cromato

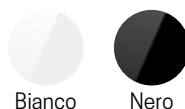

Bianco Nero

Finitura	Codice	Prezzo
Bianco	<b>SED01FM-A</b>	412 €
Nero	<b>SED01FM-H</b>	454 €

## ACCESSORI



### CESTINO SGANCIABILE

Cestino sganciabile in metallo cromato

Codice	Prezzo
<b>R90CESTE0F</b>	114 €

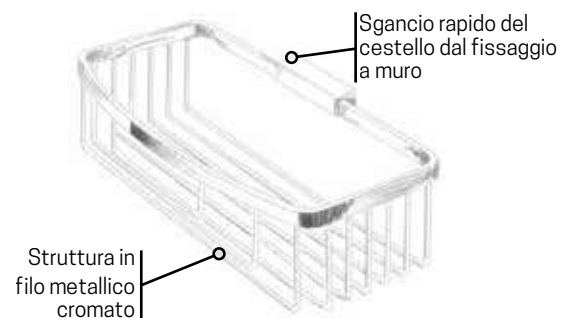

### CESTINO ANGOLARE SGANCIABILE

Cestino sganciabile in metallo cromato

Codice	Prezzo
<b>R90CESTE0G</b>	114 €



### CESTINO DOPPIO APPENDIBILE

Cestino appendibile in metallo cromato

Codice	Prezzo
<b>R90CESTE0H</b>	253 €





### CESTINO SGANCIABILE

Cestino sganciabile in metallo cromato

Colore vaschetta interna in plastica:

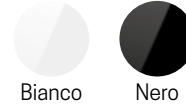

Finitura	Codice	Prezzo
Bianco	<b>R90CESTE0A-A</b>	120 €
Nero	<b>R90CESTE0A-H</b>	120 €

X 22 cm  
Y 7 cm  
Z 11 cm



### CESTINO ANGOLARE A 2 FERITOIE

Cestino contenitore con struttura in metallo cromato e vaschetta estraibile per la pulizia in plastica bianca RAL 9003 o nera RAL 7021

Colore vaschetta interna in plastica:



Finitura	Codice	Prezzo
Bianco	<b>R90CESTE0B-A</b>	120 €
Nero	<b>R90CESTE0B-H</b>	120 €

X 17 cm  
Y 7 cm  
Z 16 cm



### CESTINO ANGOLARE DOPPIO A 2 FERITOIE

Cestino doppio contenitore con struttura in metallo cromato e vaschetta estraibile per la pulizia in plastica bianca RAL 9003 o nera RAL 7021

Colore vaschetta interna in plastica:



Finitura	Codice	Prezzo
Bianco	<b>R90CESTE0D-A</b>	253 €
Nero	<b>R90CESTE0D-H</b>	253 €

X 17 cm  
Y 38 cm  
Z 16 cm

## ACCESSORI



### CESTINO DOPPIO A 2 FERITOIE

Cestino doppio contenitore con struttura in metallo cromato e vaschetta estraibile per la pulizia in plastica bianca RAL 9003 o nera RAL 7021

Colore vaschetta interna in plastica:

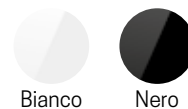

Finitura	Codice	Prezzo
Bianco	<b>R90CESTE0E-A</b>	294 €
Nero	<b>R90CESTE0E-H</b>	294 €

X 22 cm  
Y 65 cm  
Z 16 cm



### MANIGLIONE DI SICUREZZA

Maniglione in metallo verniciato antiscivolo o cromato

Finitura	Codice	Prezzo
Bianco	<b>R90MANGL0C-A</b>	162 €
Nero opaco	<b>R90MANGL0C-H</b>	204 €
Cromo	<b>R90MANGL0C-K</b>	247 €

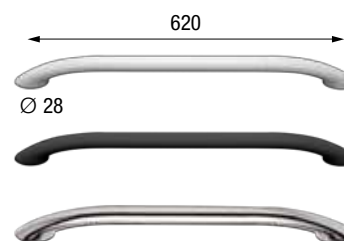



**APPENDINO DOPPIO**

Appendino cromato per vetri fino a 10mm di spessore

Codice	Prezzo
<b>R90APPEN0G</b>	20 €

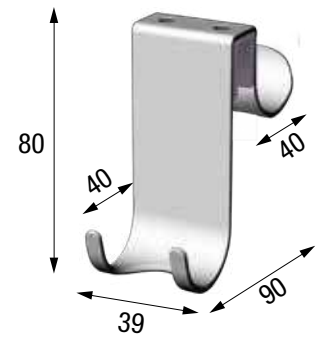

**APPENDINO**

Appendino cromato per vetri fino a 10mm di spessore

Codice	Prezzo
<b>R90APPEN0D</b>	20 €

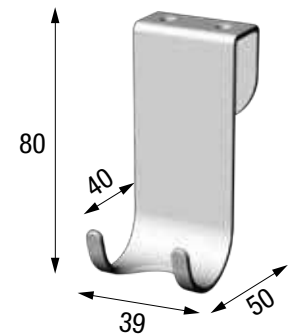

**APPENDINO**

Appendino cromato per parete  
(Adesivo di fissaggio in dotazione)

Codice	Prezzo
<b>R90APPEN0E</b>	17 €

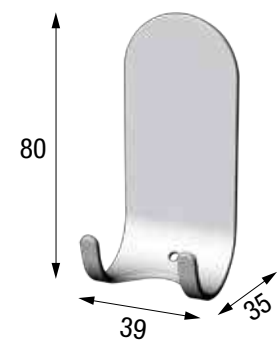

**APPENDINO**

Appendino in metallo cromato

Codice	Prezzo
<b>R90APPEN0F</b>	20 €

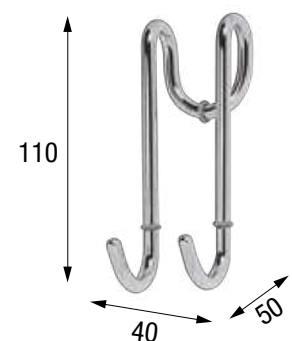

## ACCESSORI

### BARRA DI SOSTEGNO 150 cm

(tipo Kuadra H)



Finitura	Codice	Prezzo
Bianco	<b>R80GIANF15-A</b>	93 €
Bianco opaco	<b>R80GIANF15-U</b>	93 €
Silver	<b>R80GIANF15-B</b>	104 €
Cromo	<b>R80GIANF15-K</b>	115 €
Nero opaco	<b>R80GIANF15-H</b>	115 €
Inox sp.	<b>R80GIANF15-Z</b>	138 €

### BARRA DI SOSTEGNO 150 cm

(tipo Lunes H)



Finitura	Codice	Prezzo
Bianco	<b>R80LUH15-A</b>	60 €
Silver	<b>R80LUH15-B</b>	65 €
Cromo	<b>R80LUH15-K</b>	72 €

### BARRA DI SOSTEGNO AD ANGOLO

Finitura cromo



Finitura	Misure	Codice	Prezzo
Bianco opaco	25 cm	<b>R80LOU250-U</b>	72 €
Cromo	25 cm	<b>R80LOU250-K</b>	72 €
Nero opaco	25 cm	<b>R80LOU250-H</b>	72 €
Inox sp.	25 cm	<b>R80LOU250-Z</b>	87 €
Bianco opaco	35 cm	<b>R80LOU350-U</b>	78 €
Cromo	35 cm	<b>R80LOU350-K</b>	78 €
Nero opaco	35 cm	<b>R80LOU350-H</b>	78 €
Inox sp.	35 cm	<b>R80LOU350-Z</b>	94 €
Bianco opaco	45 cm	<b>R80LOU450-U</b>	85 €
Cromo	45 cm	<b>R80LOU450-K</b>	85 €
Nero opaco	45 cm	<b>R80LOU450-H</b>	85 €
Inox sp.	45 cm	<b>R80LOU450-Z</b>	102 €

### BARRA DI SOSTEGNO A MURO

(per Aurora/Star)



Finitura	Codice	Prezzo
Bianco	<b>R80FIS46-A</b>	50 €
Silver	<b>R80FIS46-B</b>	59 €

### SUPPORTI PER LA BARRA DI SOSTEGNO A SOFFITTO



Finitura	Codice	Prezzo
Bianco	<b>R801SOFEL-A</b>	40 €
Cromo	<b>R801SOFEL-K</b>	43 €
Nero opaco	<b>R801SOFEL-H</b>	43 €

### PROFILO DI FISSAGGIO A SOFFITTO PER VETRI 6/8MM - H297CM



Finitura	Codice	Prezzo
Bianco	<b>R80GKHSOF-D</b>	190 €
Bianco opaco	<b>R80GKHSOF-U</b>	190 €
Silver	<b>R80GKHSOF-B</b>	209 €
Cromo	<b>R80GKHSOF-K</b>	230 €
Nero opaco	<b>R80GKHSOF-H</b>	230 €
Inox sp.	<b>R80GKHSOF-Z</b>	276 €

**PIEDINI DI FISSAGGIO DEL VETRO AL SUOLO**

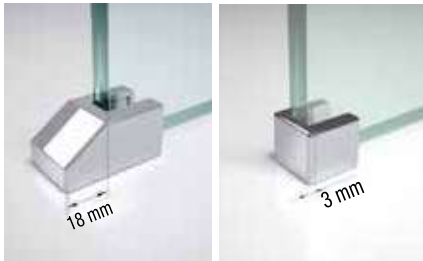

Finitura	Codice	Prezzo
PER KUADRA H (8 MM)		
Bianco	<b>R05PIKUH1-A</b>	15 €
Cromo	<b>R05PIKUH1-K</b>	18 €
Nero opaco	<b>R05PIKUH1-H</b>	18 €
Inox sp.	<b>R05PIKUH1-Z</b>	22 €
PER GIADA H (6 MM)		
Bianco	<b>R05PIGIH1-A</b>	15 €
Cromo	<b>R05PIGIH1-K</b>	18 €

**PROFILO DI TENUTA IN ALLUMINIO per fissi da 6/8 mm**



Finitura	Misure	Codice	Prezzo
Bianco	100	<b>P51BOHU10-A</b>	28 €
Bianco opaco		<b>P51BOHU10-U</b>	28 €
Silver		<b>P51BOHU10-B</b>	33 €
Cromo		<b>P51BOHU10-K</b>	37 €
Nero opaco		<b>P51BOHU10-H</b>	37 €
Inox sp.		<b>P51BOHU10-Z</b>	45 €

**PIEDINO DI FISSAGGIO INTERNO AL PIATTO DOCCIA Ø 29 mm**



Codice	Prezzo
<b>R05KUHL1-K</b>	60 €

**BARRA DI SOSTEGNO ORIENTABILE**



Finitura	Misure	Codice	Prezzo
Bianco opaco	100	<b>R80KUOR100-U</b>	105 €
Silver	100	<b>R80KUOR100-B</b>	117 €
Cromo	100	<b>R80KUOR100-K</b>	127 €
Nero opaco	100	<b>R80KUOR100-H</b>	127 €
Inox sp.	100	<b>R80KUOR100-Z</b>	153 €
Bianco opaco	150	<b>R80KUOR150-U</b>	109 €
Silver	150	<b>R80KUOR150-B</b>	120 €
Cromo	150	<b>R80KUOR150-K</b>	132 €
Nero opaco	150	<b>R80KUOR150-H</b>	132 €
Inox sp.	150	<b>R80KUOR150-Z</b>	159 €
Bianco opaco	180	<b>R80KUOR180-U</b>	114 €
Silver	180	<b>R80KUOR180-B</b>	124 €
Cromo	180	<b>R80KUOR180-K</b>	135 €
Nero opaco	180	<b>R80KUOR180-H</b>	135 €
Inox sp.	180	<b>R80KUOR180-Z</b>	162 €

1 barra orientabile da 100/150/180 cm (accorciabile), 1 attacco a muro, 1 morsetto di fissaggio al vetro

**FILTRO ADDOLCITORE PER CABINE**

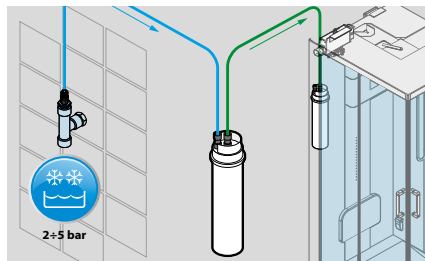

Codice	Prezzo
<b>R90FLTATC01</b>	204 €

# MANIGLIE PER BOX DOCCIA

<p><b>Interasse 256 mm</b> KUADRA, LOUVRE</p>  <table border="1"> <thead> <tr> <th>Finitura</th> <th>Codice</th> <th>Prezzo</th> </tr> </thead> <tbody> <tr> <td>Cromo</td> <td><b>R40EIMAGIN1-K</b></td> <td>113 €</td> </tr> </tbody> </table>	Finitura	Codice	Prezzo	Cromo	<b>R40EIMAGIN1-K</b>	113 €	<p><b>Interasse 256 mm</b> ROSE ROSSE</p>  <table border="1"> <thead> <tr> <th>Finitura</th> <th>Codice</th> <th>Prezzo</th> </tr> </thead> <tbody> <tr> <td>Cromo</td> <td><b>R40MAROS1-K</b></td> <td>65 €</td> </tr> </tbody> </table>	Finitura	Codice	Prezzo	Cromo	<b>R40MAROS1-K</b>	65 €	<p><b>Interasse 256 mm</b> ROSE ROSSE</p>  <table border="1"> <thead> <tr> <th>Finitura</th> <th>Codice</th> <th>Prezzo</th> </tr> </thead> <tbody> <tr> <td>Cromo</td> <td><b>R40MACNF1-K</b></td> <td>72 €</td> </tr> </tbody> </table>	Finitura	Codice	Prezzo	Cromo	<b>R40MACNF1-K</b>	72 €	<p><b>Interasse 256 mm</b> ROSE ROSSE</p>  <table border="1"> <thead> <tr> <th>Finitura</th> <th>Codice</th> <th>Prezzo</th> </tr> </thead> <tbody> <tr> <td>Cromo</td> <td><b>R40MANEX1-K</b></td> <td>99 €</td> </tr> </tbody> </table>	Finitura	Codice	Prezzo	Cromo	<b>R40MANEX1-K</b>	99 €						
Finitura	Codice	Prezzo																															
Cromo	<b>R40EIMAGIN1-K</b>	113 €																															
Finitura	Codice	Prezzo																															
Cromo	<b>R40MAROS1-K</b>	65 €																															
Finitura	Codice	Prezzo																															
Cromo	<b>R40MACNF1-K</b>	72 €																															
Finitura	Codice	Prezzo																															
Cromo	<b>R40MANEX1-K</b>	99 €																															
<p><b>Interasse 256 mm</b> ROSE ROSSE</p>  <table border="1"> <thead> <tr> <th>Finitura</th> <th>Codice</th> <th>Prezzo</th> </tr> </thead> <tbody> <tr> <td>Cristallo</td> <td><b>R40MAROS2-K</b></td> <td>65 €</td> </tr> </tbody> </table>	Finitura	Codice	Prezzo	Cristallo	<b>R40MAROS2-K</b>	65 €	<p><b>Interasse 140 mm</b></p>  <table border="1"> <thead> <tr> <th>Finitura</th> <th>Codice</th> <th>Prezzo</th> </tr> </thead> <tbody> <tr> <td>Cromo</td> <td><b>R40MATWS1-K</b></td> <td>55 €</td> </tr> <tr> <td>Nero opaco</td> <td><b>R40MATWS1-H</b></td> <td>55 €</td> </tr> </tbody> </table>	Finitura	Codice	Prezzo	Cromo	<b>R40MATWS1-K</b>	55 €	Nero opaco	<b>R40MATWS1-H</b>	55 €	<p><b>Interasse 140 mm</b></p>  <table border="1"> <thead> <tr> <th>Finitura</th> <th>Codice</th> <th>Prezzo</th> </tr> </thead> <tbody> <tr> <td>Cromo</td> <td><b>R40MAYOU2-K</b></td> <td>55 €</td> </tr> </tbody> </table>	Finitura	Codice	Prezzo	Cromo	<b>R40MAYOU2-K</b>	55 €	<p><b>Interasse 140 mm</b></p>  <table border="1"> <thead> <tr> <th>Finitura</th> <th>Codice</th> <th>Prezzo</th> </tr> </thead> <tbody> <tr> <td>Bianco</td> <td><b>R40MAEV1-A</b></td> <td>19 €</td> </tr> <tr> <td>Cromo</td> <td><b>R40MAEV1-K</b></td> <td>24 €</td> </tr> </tbody> </table>	Finitura	Codice	Prezzo	Bianco	<b>R40MAEV1-A</b>	19 €	Cromo	<b>R40MAEV1-K</b>	24 €
Finitura	Codice	Prezzo																															
Cristallo	<b>R40MAROS2-K</b>	65 €																															
Finitura	Codice	Prezzo																															
Cromo	<b>R40MATWS1-K</b>	55 €																															
Nero opaco	<b>R40MATWS1-H</b>	55 €																															
Finitura	Codice	Prezzo																															
Cromo	<b>R40MAYOU2-K</b>	55 €																															
Finitura	Codice	Prezzo																															
Bianco	<b>R40MAEV1-A</b>	19 €																															
Cromo	<b>R40MAEV1-K</b>	24 €																															
<p><b>Interasse 256 mm</b> ROSE ROSSE - LOUVRE - SKILL</p>  <table border="1"> <thead> <tr> <th>Finitura</th> <th>Codice</th> <th>Prezzo</th> </tr> </thead> <tbody> <tr> <td>Cromo</td> <td><b>R40EIMAGIN1-K</b></td> <td>113 €</td> </tr> </tbody> </table>	Finitura	Codice	Prezzo	Cromo	<b>R40EIMAGIN1-K</b>	113 €	<p><b>Interasse 256 mm</b> ROSE ROSSE - LOUVRE - SKILL</p>  <table border="1"> <thead> <tr> <th>Finitura</th> <th>Codice</th> <th>Prezzo</th> </tr> </thead> <tbody> <tr> <td>Cromo</td> <td><b>R40EIMACNF1-K</b></td> <td>119 €</td> </tr> </tbody> </table>	Finitura	Codice	Prezzo	Cromo	<b>R40EIMACNF1-K</b>	119 €	<p><b>Interasse 140 mm</b> CRYSTAL</p>  <table border="1"> <thead> <tr> <th>Finitura</th> <th>Codice</th> <th>Prezzo</th> </tr> </thead> <tbody> <tr> <td>Cromo</td> <td><b>R40EIMAZPH2-K</b></td> <td>94 €</td> </tr> <tr> <td>Nero</td> <td><b>R40EIMAZPH2-H</b></td> <td>94 €</td> </tr> </tbody> </table>	Finitura	Codice	Prezzo	Cromo	<b>R40EIMAZPH2-K</b>	94 €	Nero	<b>R40EIMAZPH2-H</b>	94 €	<p><b>Interasse 384 mm</b> YOUNG - YOUNG PLUS - EON</p>  <table border="1"> <thead> <tr> <th>Finitura</th> <th>Codice</th> <th>Prezzo</th> </tr> </thead> <tbody> <tr> <td>Cromo</td> <td><b>R40EIMAY21-K</b></td> <td>88 €</td> </tr> <tr> <td>Nero</td> <td><b>R40EIMAY21-H</b></td> <td>88 €</td> </tr> </tbody> </table>	Finitura	Codice	Prezzo	Cromo	<b>R40EIMAY21-K</b>	88 €	Nero	<b>R40EIMAY21-H</b>	88 €
Finitura	Codice	Prezzo																															
Cromo	<b>R40EIMAGIN1-K</b>	113 €																															
Finitura	Codice	Prezzo																															
Cromo	<b>R40EIMACNF1-K</b>	119 €																															
Finitura	Codice	Prezzo																															
Cromo	<b>R40EIMAZPH2-K</b>	94 €																															
Nero	<b>R40EIMAZPH2-H</b>	94 €																															
Finitura	Codice	Prezzo																															
Cromo	<b>R40EIMAY21-K</b>	88 €																															
Nero	<b>R40EIMAY21-H</b>	88 €																															

## PROFILO DI FINITURA L. 400 cm



Codice	Prezzo
<b>PRVA2-A</b>	92 €

## KIT 2 PROFILI DI FINITURA RIGIDI IN PLASTICA 195 cm

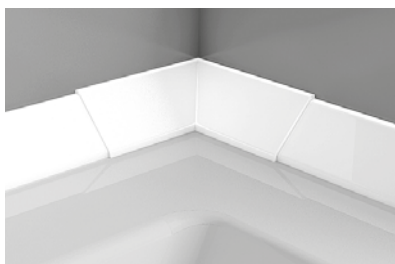

Codice	Prezzo
<b>PRVA195-30</b>	74 €

## PROFILO DI FINITURA RIGIDO IN ALLUMINIO



Misure	Codice	Prezzo
1 lato 185 cm	<b>PRV185-30</b>	84 €
2 lati 185x85 cm	<b>PRV18585-30</b>	108 €
3 lati 85x185x85 cm	<b>PRV8518585-30</b>	128 €

## PANNELLO D'ISPEZIONE PER VASCA AD INCASSO 60x33x2 cm



SENSE

Codice	Prezzo
<b>PANISPEL-A</b>	167 €

IRIS, CALOS 2.0, UNA, VOGUE, VENUS, CALYPSO, BABY

Codice	Prezzo
<b>PANISP-A</b>	167 €

## COLONNA DI SCARICO



Codice	Prezzo
<b>COLSCAVK-K</b>	99 €

## TUBO DI SCARICO SALVAGOCCIA



STILE, IRIS, CALOS 2.0, UNA, VOGUE, VENUS, CALYPSO

Codice	Prezzo
<b>R90SCDOCBV</b>	139 €

SENSE, DIVINA

Codice	Prezzo
<b>R90SGCVSEDI</b>	139 €

## KIT PIEDINI REGOLABILI



Codice	Prezzo
<b>PIEDVASCA</b>	64 €

## KIT PIEDINI REGOLABILI PER VASCHE AD INCASSO



Codice	Prezzo
<b>PIEDVASCA70</b>	70 €
<b>PIEDVASCA75</b>	70 €
<b>PIEDVASCA80</b>	70 €
<b>PIEDVASCA90</b>	70 €
<b>PIEDVASCA100</b>	70 €

## KIT PULIZIA 12 FLACONI con vaporizzatore



Codice	Prezzo
<b>KITPUPV12</b>	193 €

# PROFILI PER BOX DOCCIA

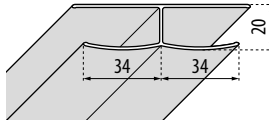

**LUNES / STAR 2.0** H 195 cm  
**ZEPHYROS 2.0** H 200 cm  
**STAR** H 185 cm

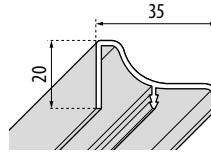

**LUNES / STAR 2.0** H 195 cm  
**ZEPHYROS 2.0** H 200 cm  
**STAR** H 185 cm

Finitura	Codice			Misure altezza (max 200 cm)		
	LUNES STAR 2.0	ZEPHYROS 2.0	STAR	Standard	Speciale	
					<190	>190
Bianco	PROH15ST3-A	PROH15ST2-U	PROH15ST1-A	58 €		
	PROH1501	PROH1501	PROH1501		62 €	
	PROH1502	PROH1502	PROH1502			66 €
Silver	PROH15ST3-B	PROH15ST2-B	PROH15ST1-B	65 €		
	PROH1501	PROH1501	PROH1501		69 €	
	PROH1502	PROH1502	PROH1502			74 €
Cromo	PROH15ST3-K	PROH15ST2-K		72 €		
	PROH1501	PROH1501			77 €	
	PROH1502	PROH1502				82 €
Nero opaco	PROH15ST3-H	PROH15ST2-H		72 €		
	PROH1501	PROH1501			77 €	
	PROH1502	PROH1502				82 €
Argento	PROH15ST3-J			67 €		
	PROH1501				72 €	
	PROH1502					77 €

Finitura	Codice			Misure altezza (max 200 cm)		
	LUNES STAR 2.0	ZEPHYROS 2.0	STAR	Standard	Speciale	
					<190	>190
Bianco	PRO002ST3-A	PRO002ST2-U	PRO002ST1-A	58 €		
	PRO00201	PRO00201	PRO00201		62 €	
	PRO00202	PRO00202	PRO00202			66 €
Silver	PRO002ST3-B	PRO002ST2-B	PRO002ST1-B	65 €		
	PRO00201	PRO00201	PRO00201		69 €	
	PRO00202	PRO00202	PRO00202			74 €
Cromo	PRO002ST3-K	PRO002ST2-K		72 €		
	PRO00201	PRO00201			77 €	
	PRO00202	PRO00202				82 €
Nero opaco	PRO002ST3-H	PRO002ST2-H		72 €		
	PRO00201	PRO00201			77 €	
	PRO00202	PRO00202				82 €
Argento	PRO002ST3-J			67 €		
	PRO00201				72 €	
	PRO00202					77 €

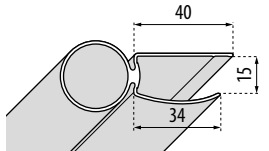

**LUNES / STAR 2.0** H 195 cm  
**ZEPHYROS 2.0** H 200 cm  
**STAR** H 185 cm

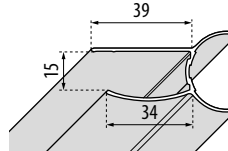

**LUNES / STAR 2.0** H 195 cm  
**ZEPHYROS 2.0** H 200 cm  
**STAR** H 185 cm

Finitura	Codice			Misure altezza (max 200 cm)		
	LUNES STAR 2.0	ZEPHYROS 2.0	STAR	Standard	Speciale	
					<190	>190
Bianco	INCB001ST3-A	INCB001ST2-U	INCB001ST1-A	61 €		
	INCB00101	INCB00101	INCB00101		65 €	
	INCB00102	INCB00102	INCB00102			69 €
Silver	INCB001ST3-B	INCB001ST2-B	INCB001ST1-B	68 €		
	INCB00101	INCB00101	INCB00101		72 €	
	INCB00102	INCB00102	INCB00102			77 €
Cromo	INCB001ST3-K	INCB001ST2-K		75 €		
	INCB00101	INCB00101			80 €	
	INCB00102	INCB00102				86 €
Nero opaco	INCB001ST3-H	INCB001ST2-H		75 €		
	INCB00101	INCB00101			80 €	
	INCB00102	INCB00102				86 €
Argento	INCB001ST3-J			70 €		
	INCB00101				75 €	
	INCB00102					80 €

Finitura	Codice			Misure altezza (max 200 cm)		
	LUNES STAR 2.0	ZEPHYROS 2.0	STAR	Standard	Speciale	
					<190	>190
Bianco	INCA002ST3-A	INCA002ST2-U	INCA002ST1-A	60 €		
	INCA00201	INCA00201	INCA00201		64 €	
	INCA00202	INCA00202	INCA00202			68 €
Silver	INCA002ST3-B	INCA002ST2-B	INCA002ST1-B	67 €		
	INCA00201	INCA00201	INCA00201		71 €	
	INCA00202	INCA00202	INCA00202			76 €
Cromo	INCA002ST3-K	INCA002ST2-K		74 €		
	INCA00201	INCA00201			79 €	
	INCA00202	INCA00202				84 €
Nero opaco	INCA002ST3-H	INCA002ST2-H		74 €		
	INCA00201	INCA00201			79 €	
	INCA00202	INCA00202				84 €
Argento	INCA002ST3-J			64 €		
	INCA00201				68 €	
	INCA00202					73 €

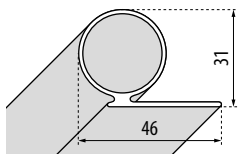

**LUNES / STAR 2.0** H 195 cm  
**ZEPHYROS 2.0** H 200 cm  
**STAR** H 185 cm

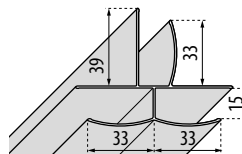

**LUNES / STAR 2.0** H 195 cm  
**ZEPHYROS 2.0** H 200 cm  
**STAR** H 185 cm

Finitura	Codice			Misure altezza (max 200 cm)		
	LUNES STAR 2.0	ZEPHYROS 2.0	STAR	Standard	Speciale	
					<190	>190
Bianco	INCA005ST3-A	INCA005ST2-U	INCA005ST1-A	60 €		
	INCA00501	INCA00501	INCA00501		64 €	
	INCA00502	INCA00502	INCA00502			68 €
Silver	INCA005ST3-B	INCA005ST2-B	INCA005ST1-B	67 €		
	INCA00501	INCA00501	INCA00501		71 €	
	INCA00502	INCA00502	INCA00502			76 €
Cromo	INCA005ST3-K	INCA005ST2-K		74 €		
	INCA00501	INCA00501			79 €	
	INCA00502	INCA00502				84 €
Nero opaco	INCA005ST3-H	INCA005ST2-H		74 €		
	INCA00501	INCA00501			79 €	
	INCA00502	INCA00502				84 €
Argento	INCA005ST3-J			64 €		
	INCA00501				68 €	
	INCA00502					73 €
Inox		INCA005ST2-Z		89 €		
		INCA00501			95 €	
		INCA00502				101 €

Finitura	Codice			Misure altezza (max 200 cm)		
	LUNES STAR 2.0	ZEPHYROS 2.0	STAR	Standard	Speciale	
					<190	>190
Bianco	PRT15ST3-A	PRT15ST2-U	PRT15ST1-A	80 €		
	PRT1501	PRT1501	PRT1501		86 €	
	PRT1502	PRT1502	PRT1502			91 €
Silver	PRT15ST3-B	PRT15ST2-B	PRT15ST1-B	89 €		
	PRT1501	PRT1501	PRT1501		95 €	
	PRT1502	PRT1502	PRT1502			102 €
Cromo	PRT15ST3-K	PRT15ST2-K		99 €		
	PRT1501	PRT1501			106 €	
	PRT1502	PRT1502				113 €
Nero opaco	PRT15ST3-H	PRT15ST2-H		99 €		
	PRT1501	PRT1501			106 €	
	PRT1502	PRT1502				113 €
Argento	PRT15ST3-J			86 €		
	PRT1501				92 €	
	PRT1502					98 €



# PROFILI PER BOX DOCCIA

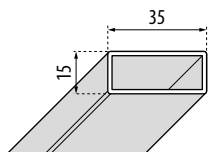

**LUNES / STAR 2.0** H 195 cm  
**ZEPHYROS 2.0** H 200 cm  
**STAR** H 185 cm

Finitura	Codice			Misure altezza (max 200 cm)		
	LUNES STAR 2.0	ZEPHYROS 2.0	STAR	Standard	Speciale	
					<190	>190
Bianco	P15X35ST3-A	P15X35ST2-U	P15X35ST1-A	52 €		
	P15X3501	P15X3501	P15X3501		55 €	
	P15X3502	P15X3502	P15X3502			59 €
Silver	P15X35ST3-B	P15X35ST2-B	P15X35ST1-B	58 €		
	P15X3501	P15X3501	P15X3501		62 €	
	P15X3502	P15X3502	P15X3502			66 €
Cromo	P15X35ST3-K	P15X35ST2-K		64 €		
	P15X3501	P15X3501			68 €	
	P15X3502	P15X3502				73 €
Nero opaco	P15X35ST3-H	P15X35ST2-H		64 €		
	P15X3501	P15X3501			68 €	
	P15X3502	P15X3502				73 €
Argento	P15X35ST3-J			55 €		
	P15X3501				59 €	
	P15X3502					63 €

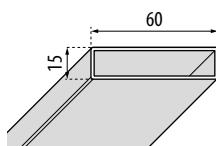

**LUNES / STAR 2.0** H 195 cm  
**ZEPHYROS 2.0** H 200 cm  
**STAR** H 185 cm

Finitura	Codice			Misure altezza (max 200 cm)		
	LUNES STAR 2.0	ZEPHYROS 2.0	STAR	Standard	Speciale	
					<190	>190
Bianco	P15X60ST3-A	P15X60ST2-U	P15X60ST1-A	62 €		
	P15X6001	P15X6001	P15X6001		66 €	
	P15X6002	P15X6002	P15X6002			70 €
Silver	P15X60ST3-B	P15X60ST2-B	P15X60ST1-B	68 €		
	P15X6001	P15X6001	P15X6001		73 €	
	P15X6002	P15X6002	P15X6002			78 €
Cromo	P15X60ST3-K	P15X60ST2-K		76 €		
	P15X6001	P15X6001			81 €	
	P15X6002	P15X6002				87 €
Nero opaco	P15X60ST3-H	P15X60ST2-H		76 €		
	P15X6001	P15X6001			81 €	
	P15X6002	P15X6002				87 €
Argento	P15X60ST3-J			66 €		
	P15X6001				70 €	
	P15X6002					75 €

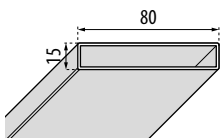

**LUNES / STAR 2.0** H 195 cm  
**ZEPHYROS 2.0** H 200 cm  
**STAR** H 185 cm

Finitura	Codice			Misure altezza		
	LUNES STAR 2.0	ZEPHYROS 2.0	STAR	Standard	Speciale	
					<190	>190
Bianco	P15X80ST3-A	P15X80ST2-U	P15X80ST1-A	68 €		
	P15X8001	P15X8001	P15X8001		73 €	
	P15X8002	P15X8002	P15X8002			78 €
Silver	P15X80ST3-B	P15X80ST2-B	P15X80ST1-B	76 €		
	P15X8001	P15X8001	P15X8001		81 €	
	P15X8002	P15X8002	P15X8002			86 €
Cromo	P15X80ST3-K	P15X80ST2-K		84 €		
	P15X8001	P15X8001			90 €	
	P15X8002	P15X8002				96 €
Nero opaco	P15X80ST3-H	P15X80ST2-H		84 €		
	P15X8001	P15X8001			90 €	
	P15X8002	P15X8002				96 €
Argento	P15X80ST3-J			73 €		
	P15X8001				78 €	
	P15X8002					83 €

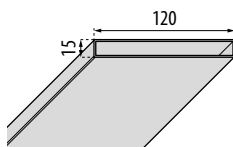

**LUNES / STAR 2.0** H 195 cm  
**ZEPHYROS 2.0** H 200 cm  
**STAR** H 185 cm

Finitura	Codice			Misure altezza (max 200 cm)		
	LUNES STAR 2.0	ZEPHYROS 2.0	STAR	Standard	Speciale	
					<190	>190
Bianco	P15X120ST3-A	P15X120ST2-U	P15X120ST1-A	80 €		
	P15X12001	P15X12001	P15X12001		86 €	
	P15X12002	P15X12002	P15X12002			91 €
Silver	P15X120ST3-B	P15X120ST2-B	P15X120ST1-B	89 €		
	P15X12001	P15X12001	P15X12001		95 €	
	P15X12002	P15X12002	P15X12002			102 €
Cromo	P15X120ST3-K	P15X120ST2-K		99 €		
	P15X12001	P15X12001			106 €	
	P15X12002	P15X12002				113 €
Nero opaco	P15X120ST3-H	P15X120ST2-H		99 €		
	P15X12001	P15X12001			106 €	
	P15X12002	P15X12002				113 €
Argento	P15X120ST3-J			86 €		
	P15X12001				92 €	
	P15X12002					98 €

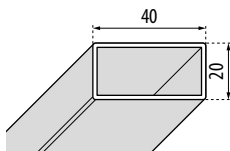

**LUNES / STAR 2.0** H 195 cm  
**ZEPHYROS 2.0** H 200 cm  
**STAR** H 185 cm

Finitura	Codice			Misure altezza (max 200 cm)		
	LUNES STAR 2.0	ZEPHYROS 2.0	STAR	Standard	Speciale	
					<190	>190
Bianco	P20X40ST3-A	P20X40ST2-U	P20X40ST1-A	63 €		
	P20X4001	P20X4001	P20X4001		68 €	
	P20X4002	P20X4002	P20X4002			72 €
Silver	P20X40ST3-B	P20X40ST2-B	P20X40ST1-B	70 €		
	P20X4001	P20X4001	P20X4001		75 €	
	P20X4002	P20X4002	P20X4002			80 €
Cromo	P20X40ST3-K	P20X40ST2-K		78 €		
	P20X4001	P20X4001			83 €	
	P20X4002	P20X4002				89 €
Nero opaco	P20X40ST3-H	P20X40ST2-H		78 €		
	P20X4001	P20X4001			83 €	
	P20X4002	P20X4002				89 €
Argento	P20X40ST3-J			67 €		
	P20X4001				72 €	
	P20X4002					77 €

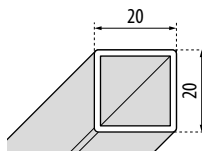

**LUNES / STAR 2.0** H 195 cm  
**ZEPHYROS 2.0** H 200 cm  
**STAR** H 185 cm

Finitura	Codice			Misure altezza (max 200 cm)		
	LUNES STAR 2.0	ZEPHYROS 2.0	STAR	Standard	Speciale	
					<195	>195
Bianco	P20X20ST3-A	P20X20ST2-U	P20X20ST1-A	53 €		
	P20X2001	P20X2001	P20X2001		56 €	
	P20X2002	P20X2002	P20X2002			60 €
Silver	P20X20ST3-B	P20X20ST2-B	P20X20ST1-B	59 €		
	P20X2001	P20X2001	P20X2001		63 €	
	P20X2002	P20X2002	P20X2002			67 €
Cromo	P20X20ST3-K	P20X20ST2-K		65 €		
	P20X2001	P20X2001			70 €	
	P20X2002	P20X2002				74 €
Nero opaco	P20X20ST3-H	P20X20ST2-H		65 €		
	P20X2001	P20X2001			70 €	
	P20X2002	P20X2002				74 €
Argento	P20X20ST3-J			56 €		
	P20X2001				60 €	
	P20X2002					64 €

# PROFILI PER BOX DOCCIA

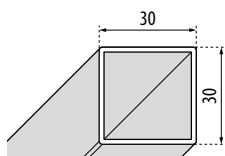

**LUNES / STAR 2.0** H 195 cm  
**ZEPHYROS 2.0** H 200 cm  
**STAR** H 185 cm

Finitura	Codice			Misure altezza (max 200 cm)		
	LUNES	ZEPHYROS 2.0	STAR	Standard	Speciale	
	STAR 2.0				<195	>195
Bianco	P30X30ST3-A	P30X30200ST-U	P30X30ST1-A	61 €		
	P30X3001	P30X3001	P30X3001		65 €	
	P30X3002	P30X3002	P30X3002			69 €
Silver	P30X30ST3-B	P30X30200ST-B	P30X30ST1-B	68 €		
	P30X3001	P30X3001	P30X3001		72 €	
	P30X3002	P30X3002	P30X3002			77 €
Cromo	P30X30ST3-K	P30X30200ST-K		75 €		
	P30X3001	P30X3001			80 €	
	P30X3002	P30X3002				86 €
Nero opaco	P30X30ST3-H	P30X30200ST-H		75 €		
	P30X3001	P30X3001			80 €	
	P30X3002	P30X3002				86 €
Argento	P30X30ST3-J			65 €		
	P30X3001				69 €	
	P30X3002					74 €

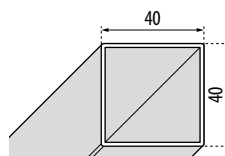

**LUNES / STAR 2.0** H 195 cm  
**ZEPHYROS 2.0** H 200 cm  
**STAR** H 185 cm

Finitura	Codice			Misure altezza (max 200 cm)		
	LUNES	ZEPHYROS 2.0	STAR	Standard	Speciale	
	STAR 2.0				<190	>190
Bianco	P40X40ST3-A	P40X40ST2-U	P40X40ST1-A	63 €		
	P40X4001	P40X4001	P40X4001		68 €	
	P40X4002	P40X4002	P40X4002			72 €
Silver	P40X40ST3-B	P40X40ST2-B	P40X40ST1-B	70 €		
	P40X4001	P40X4001	P40X4001		75 €	
	P40X4002	P40X4002	P40X4002			80 €
Cromo	P40X40ST3-K	P40X40ST2-K		78 €		
	P40X4001	P40X4001			83 €	
	P40X4002	P40X4002				89 €
Nero opaco	P40X40ST3-H	P40X40ST2-H		78 €		
	P40X4001	P40X4001			83 €	
	P40X4002	P40X4002				89 €
Argento	P40X40ST3-J			67 €		
	P40X4001				72 €	
	P40X4002					77 €

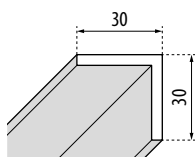

**LUNES / STAR 2.0** H 195 cm  
**ZEPHYROS 2.0** H 200 cm  
**STAR** H 185 cm

Finitura	Codice			Misure altezza (max 200 cm)		
	LUNES	ZEPHYROS 2.0	STAR	Standard	Speciale	
	STAR 2.0				<190	>190
Bianco	L30X30ST3-A	L30X30ST2-U	L30X30ST1-A	56 €		
	L30X3001	L30X3001	L30X3001		60 €	
	L30X3002	L30X3002	L30X3002			64 €
Silver	L30X30ST3-B	L30X30ST2-B	L30X30ST1-B	62 €		
	L30X3001	L30X3001	L30X3001		66 €	
	L30X3002	L30X3002	L30X3002			71 €
Cromo	L30X30ST3-K	L30X30ST2-K		69 €		
	L30X3001	L30X3001			74 €	
	L30X3002	L30X3002				79 €
Nero opaco	L30X30ST3-H	L30X30ST2-H		69 €		
	L30X3001	L30X3001			74 €	
	L30X3002	L30X3002				79 €
Argento	L30X30ST3-J			60 €		
	L30X3001				64 €	
	L30X3002					68 €

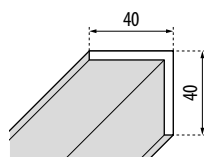

**LUNES / STAR 2.0** H 195 cm  
**ZEPHYROS 2.0** H 200 cm  
**STAR** H 185 cm

Finitura	Codice			Misure altezza (max 200 cm)		
	LUNES	ZEPHYROS 2.0	STAR	Standard	Speciale	
	STAR 2.0				<190	>190
Bianco	L40X40ST3-A	L40X40ST2-U	L40X40ST1-A	58 €		
	L40X4001	L40X4001	L40X4001		62 €	
	L40X4002	L40X4002	L40X4002			66 €
Silver	L40X40ST3-B	L40X40ST2-B	L40X40ST1-B	65 €		
	L40X4001	L40X4001	L40X4001		69 €	
	L40X4002	L40X4002	L40X4002			74 €
Cromo	L40X40ST3-K	L40X40ST2-K		72 €		
	L40X4001	L40X4001			77 €	
	L40X4002	L40X4002				82 €
Nero opaco	L40X40ST3-H	L40X40ST2-H		72 €		
	L40X4001	L40X4001			77 €	
	L40X4002	L40X4002				82 €
Argento	L40X40ST3-J			62 €		
	L40X4001				67 €	
	L40X4002					71 €

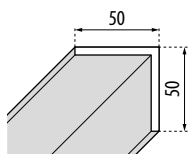

**LUNES / STAR 2.0** H 195 cm  
**ZEPHYROS 2.0** H 200 cm  
**STAR** H 185 cm

Finitura	Codice			Misure altezza (max 200 cm)		
	LUNES	ZEPHYROS 2.0	STAR	Standard	Speciale	
	STAR 2.0				<190	>190
Bianco	L50X50ST3-A	L50X50ST2-U	L50X50ST1-A	56 €		
	L50X5001	L50X5001	L50X5001		60 €	
	L50X5002	L50X5002	L50X5002			64 €
Silver	L50X50ST3-B	L50X50ST2-B	L50X50ST1-B	62 €		
	L50X5001	L50X5001	L50X5001		66 €	
	L50X5002	L50X5002	L50X5002			71 €
Cromo	L50X50ST3-K	L50X50ST2-K		69 €		
	L50X5001	L50X5001			74 €	
	L50X5002	L50X5002				79 €
Nero opaco	L50X50ST3-H	L50X50ST2-H		69 €		
	L50X5001	L50X5001			74 €	
	L50X5002	L50X5002				79 €
Argento	L50X50ST3-J			60 €		
	L50X5001				64 €	
	L50X5002					68 €

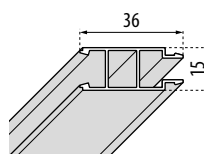

**LUNES / STAR 2.0** H 195 cm  
**ZEPHYROS 2.0** H 200 cm  
**STAR** H 185 cm

Finitura	Codice			Misure altezza (max 200 cm)		
	LUNES	ZEPHYROS 2.0	STAR	Standard	Speciale	
	STAR 2.0				<190	>190
Bianco	P05HAAST3-A	P05HAAST2-U	P05HAAST1-A	64 €		
	P05HAA01	P05HAA01	P05HAA01		68 €	
	P05HAA02	P05HAA02	P05HAA02			73 €
Silver	P05HAAST3-B	P05HAAST2-B	P05HAAST1-B	71 €		
	P05HAA01	P05HAA01	P05HAA01		76 €	
	P05HAA02	P05HAA02	P05HAA02			81 €
Cromo	P05HAAST3-K	P05HAAST2-K		79 €		
	P05HAA01	P05HAA01			85 €	
	P05HAA02	P05HAA02				90 €
Nero opaco	P05HAAST3-H	P05HAAST2-H		79 €		
	P05HAA01	P05HAA01			85 €	
	P05HAA02	P05HAA02				90 €
Argento	P05HAAST3-J			68 €		
	P05HAA01				73 €	
	P05HAA02					78 €

# PROFILI PER BOX DOCCIA

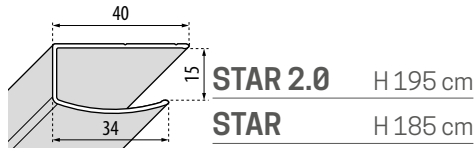

Finitura	Codice		Misure altezza (max 200 cm)	
	STAR 2.0	STAR	Standard	Speciale
Bianco	P01HAAST3-A	P01HAAST1-A	69 €	
	P01HAA01	P01HAA01		74 €
	P01HAA02	P01HAA02		78 €
Silver	P01HAAST3-B	P01HAAST1-B	77 €	
	P01HAA01	P01HAA01		82 €
	P01HAA02	P01HAA02		87 €

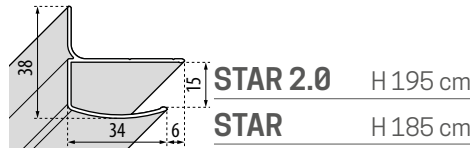

Finitura	Codice		Misure altezza (max 200 cm)	
	STAR	STAR 2.0	Standard	Speciale
Bianco	P01HAPST1-A	P01HAPCST3-A	69 €	
	P01HAP01	P01HAP01		74 €
	P01HAP02	P01HAP02		78 €
Silver	P01HAPST1-B	P01HAPCST3-B	77 €	
	P01HAP01	P01HAP01		82 €
	P01HAP02	P01HAP02		87 €



Finitura	Codice		Misure altezza (max 200 cm)	
	STAR	STAR 2.0	Standard	Speciale
Bianco	P01SACST1-A	P01SACST3-A	73 €	
	P01SAC01	P01SAC01		78 €
	P01SAC02	P01SAC02		83 €
Silver	P01SACST1-B	P01SACST3-B	81 €	
	P01SAC01	P01SAC01		87 €
	P01SAC02	P01SAC02		92 €



Finitura	Codice		Misure altezza (max 200 cm)	
	LUNES	ZEPHYROS 2.0	Standard	Speciale
Bianco	P05BHST-A	P05BHST2-U	74 €	
	P05BH01	P05BH01		79 €
	P05BH02	P05BH02		84 €
Silver	P05BHST-B	P05BHST2-B	82 €	
	P05BH01	P05BH01		88 €
	P05BH02	P05BH02		93 €
Cromo	P05BHST-K	P05BHST2-K	91 €	
	P05BH01	P05BH01		97 €
	P05BH02	P05BH02		104 €
Nero opaco	P05BHST-H	P05BHST2-H	91 €	
	P05BH01	P05BH01		97 €
	P05BH02	P05BH02		104 €
Argento	P05BHST-J		79 €	
	P05BH01			84 €
	P05BH02			90 €



Finitura	Codice		Misure altezza (max 200 cm)	
	LUNES	ZEPHYROS 2.0	Standard	Speciale
Bianco	P05BHCST-A	P05BHCST2-U	77 €	
	P05BHC01	P05BHC01		82 €
	P05BHC02	P05BHC02		88 €
Silver	P05BHCST-B	P05BHCST2-B	86 €	
	P05BHC01	P05BHC01		91 €
	P05BHC02	P05BHC02		97 €
Cromo	P05BHCST-K	P05BHCST2-K	95 €	
	P05BHC01	P05BHC01		102 €
	P05BHC02	P05BHC02		108 €
Nero opaco	P05BHCST-H	P05BHCST2-H	95 €	
	P05BHC01	P05BHC01		102 €
	P05BHC02	P05BHC02		108 €
Argento	P05BHCST-J		82 €	
	P05BHC01			88 €
	P05BHC02			94 €

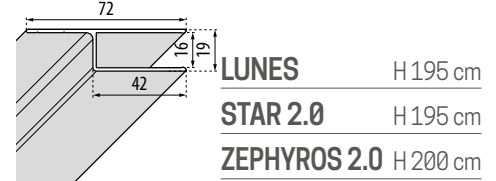

Finitura	Codice		Misure altezza (max 200 cm)	
	LUNES STAR 2.0	ZEPHYROS 2.0	Standard	Speciale
Bianco	P01L215STL-A	P01L215STL2-U	87 €	
	P01L21502SP	P01L21502SP		93 €
	P01L21502SP	P01L21502SP	96 €	99 €
Silver	P01L21502SP	P01L21502SP		103 €
	P01L21502SP	P01L21502SP		110 €
Cromo	P01L215STL-K	P01L215STL2-K	107 €	
	P01L21502SP	P01L21502SP		114 €
Nero opaco	P01L215STL-H	P01L215STL2-H	107 €	
	P01L21502SP	P01L21502SP		114 €
Argento	P01L215STL-J		92 €	
	P01L21502SP			99 €



Finitura	Codice		Misure altezza (max 200 cm)	
	ZEPHYROS 2.0	Standard	Speciale	
Bianco	P01BHRAST2-U	68 €		
	P01BHRA01		73 €	
	P01BHRA02			78 €
Silver	P01BHRAST2-B	76 €		
	P01BHRA01		81 €	
	P01BHRA02			86 €
Cromo	P01BHRAST2-K	84 €		
	P01BHRA01		90 €	
	P01BHRA02			96 €
Nero opaco	P01BHRAST2-H	84 €		
	P01BHRA01		90 €	
	P01BHRA02			96 €



Finitura	Codice		Misure altezza (max 200 cm)	
	ZEPHYROS 2.0	Standard	Speciale	
Bianco	P01BHMOST2-U	70 €		
	P01BHM001		75 €	
	P01BHM002			80 €
Silver	P01BHMOST2-B	78 €		
	P01BHM001		84 €	
	P01BHM002			89 €
Cromo	P01BHMOST2-K	87 €		
	P01BHM001		93 €	
	P01BHM002			99 €
Nero opaco	P01BHMOST2-H	87 €		
	P01BHM001		93 €	
	P01BHM002			99 €



Finitura	Codice		Misure altezza (max 200 cm)
	LUNES H	GIADA H	Standard
Bianco	P01LGHST-A	P01LGHST-A	71 €
Silver	P01LGHST-B	P01LGHST-B	79 €
Cromo	P01LGHST-K	P01LGHST-K	88 €

# PROFILI PER BOX DOCCIA

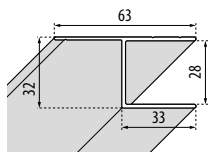

**YOUNG** H 198,4 cm

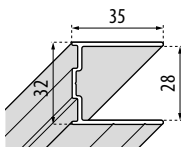

**YOUNG** H 200 cm

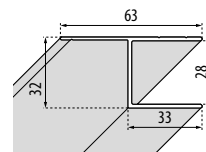

**YOUNG** H 200 cm

Finitura	Codice	Misure altezza (max 200 cm)	
		Standard	Speciale
Bianco opaco	P01Y2MOBSTL-U	116 €	
	P01Y2MOB002SP		124 €
Silver	P01Y2MOBSTL-B	128 €	
	P01Y2MOB002SP		136 €
Cromo	P01Y2MOBSTL-K	141 €	
	P01Y2MOB002SP		151 €
Nero opaco	P01Y2MOBSTL-H	141 €	
	P01Y2MOB002SP		151 €
Inox sp.	P01Y2MOBSTL-Z	170 €	
	P01Y2MOB002SP		182 €

Finitura	Codice	Misure altezza (max 200 cm)	
		Standard	
		Fisso (H 198,4)	Porta (H 200)
Bianco	P01BNMOAST-U		113 €
	P01BNMOBST-U	113 €	
Silver	P01BNMOAST-B		126 €
	P01BNMOBST-B	126 €	
Cromo	P01BNMOAST-K		140 €
	P01BNMOBST-K	140 €	
Nero opaco	P01BNMOAST-H		140 €
	P01BNMOBST-H	140 €	
Inox sp.	P01BNMOAST-Z		168 €
	P01BNMOBST-Z	168 €	

Finitura	Codice	Misure altezza (max 200 cm)	
		Standard	Speciale
Bianco opaco	P01Y2MOASTL-U	116 €	
	P01Y2MOA002SP		124 €
Silver	P01Y2MOASTL-B	128 €	
	P01Y2MOA002SP		136 €
Cromo	P01Y2MOASTL-K	141 €	
	P01Y2MOA002SP		151 €
Nero opaco	P01Y2MOASTL-H	141 €	
	P01Y2MOA002SP		151 €
Inox sp.	P01Y2MOASTL-Z	170 €	
	P01Y2MOA002SP		182 €

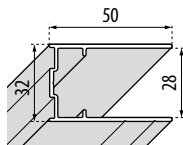

**YOUNG** H 200 cm

In sostituzione del profilo a muro +15 mm

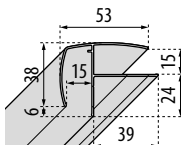

**STAR 2.0** H 195 cm

**STAR** H 185 cm

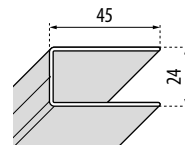

**KUADRA H** H 200 cm

Finitura	Codice	Misure altezza (max 200 cm)		
		Standard		Speciale
		Fisso (H 198,4)	Porta (H 200)	Da 140 a 200
Bianco	P05Y2ST-U	92 €		
	P05Y2ST2-U		98 €	
	P05Y2SP			104 €
Silver	P05Y2ST-B	102 €		
	P05Y2ST2-B		109 €	
	P05Y2SP			116 €
Cromo	P05Y2ST-K	113 €		
	P05Y2ST2-K		117 €	
	P05Y2SP			125 €
Nero opaco	P05Y2ST-H	113 €		
	P05Y2ST2-H		121 €	
	P05Y2SP			129 €
Inox sp.	P05Y2ST-Z	136 €		
	P05Y2ST2-Z		145 €	
	P05Y2SP			155 €

Finitura	Codice		Misure altezza (max 200 cm)	
	STAR	STAR 2.0	Standard	Speciale
			<190	>190
Bianco	P05HAFST1-A	P05HAFST3-A	64 €	
	P05HAF01	P05HAF01		68 €
	P05HAF02	P05HAF02		73 €
Silver	P05HAFST1-B	P05HAFST3-B	71 €	
	P05HAF01	P05HAF01		76 €
	P05HAF02	P05HAF02		81 €

Finitura	Codice	Misure altezza (max 200 cm)
		Standard
Bianco	P01KUHST-U	82 €
Silver	P01KUHST-B	91 €
Cromo	P01KUHST-K	101 €
Nero opaco	P01KUHST-H	101 €
Inox sp.	P01KUHST-Z	121 €

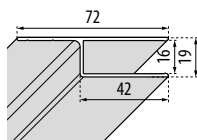

**FREE 2** H 190 cm

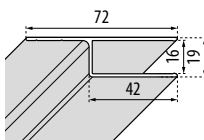

**FREE 2** H 85 cm

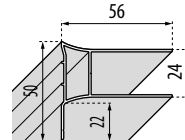

**ROSE ROSSE** H 200 cm

In sostituzione del profilo a muro +15 mm

Finitura	Codice	Misure altezza (max 200 cm)	
		Standard	Speciale
Bianco	P01FR215ASTL-A	78 €	
	P01FR215002SP		84 €
Silver	P01FR215ASTL-B	87 €	
	P01FR215002SP		93 €

Finitura	Codice	Misure altezza (max 200 cm)	
		Standard	Speciale
Bianco	P01FR215BSTL-A	78 €	
	P01FR215002SP		84 €
Silver	P01FR215BSTL-B	87 €	
	P01FR215002SP		93 €

Finitura	Codice	Misure altezza (max 200 cm)
		Standard
Bianco	P05ROSCST-A	83 €
Silver	P05ROSCST-B	92 €
Cromo	P05ROSCST-K	102 €

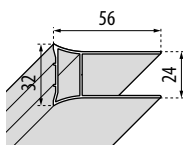

**ROSE ROSSE** H 200 cm

In sostituzione del profilo a muro +15 mm

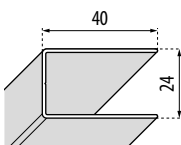

**ROSE ROSSE** H 200 cm

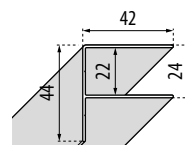

**ROSE ROSSE** H 200 cm

Finitura	Codice	Misure altezza (max 200 cm)
		Standard
Bianco	P05ROSST-A	79 €
Silver	P05ROSST-B	88 €
Cromo	P05ROSST-K	98 €

Finitura	Codice	Misure Altezza	
		Standard	Speciale
Bianco	P01BEAST-A	58 €	
	P01BEASP		62 €
Silver	P01BEAST-B	65 €	
	P01BEASP		69 €
Cromo	P01BEAST-K	72 €	
	P01BEASP		77 €

Finitura	Codice	Misure altezza (max 200 cm)	
		Standard	Speciale
Bianco	P01BEGST-A	66 €	
	P01BEGSP		70 €
Silver	P01BEGST-B	73 €	
	P01BEGSP		78 €
Cromo	P01BEGST-K	81 €	
	P01BEGSP		87 €

# PROFILI PER BOX DOCCIA

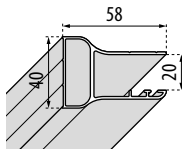

**LOUVRE** H 195 cm  
In sostituzione del profilo a muro +15 mm

Finitura	Codice	Misure altezza	
		Standard	Speciale
Silver	P05BI2MOST-B	114 €	
	P04DIA01		122 €
	P04DIA02		130 €
Cromo	P05BI2MOST-K	127 €	
	P04DIA01		136 €
	P04DIA02		145 €

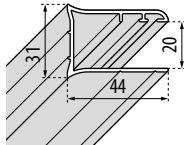

**LOUVRE** H 195 cm

Finitura	Codice	Misure altezza	
		Standard	Speciale <195
Silver	P01BI2MOST-B	96 €	
	P02DIA01		103 €
Cromo	P01BI2MOST-K	107 €	
	P02DIA01		114 €

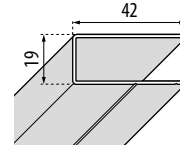

**LUNES** H 195 cm

Finitura	Codice	Misure altezza	
		Standard	Speciale <195
Bianco	P01BJMOST-A	68 €	
	P01BJMOSP		73 €
Silver	P01BJMOST-B	76 €	
	P01BJMOSP		81 €
Cromo	P01BJMOST-K	84 €	
	P01BJMOSP		90 €
Argento	P01BJMOST-J	73 €	
	P01BJMOSP		78 €

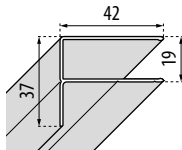

**LUNES** H 195 cm

Finitura	Codice	Misure altezza	
		Standard	Speciale
Bianco	P01BJGBST-A	70 €	
	P01BJGBSP		75 € 80 €
Silver	P01BJGBST-B	78 €	
	P01BJGBSP		84 € 89 €
Cromo	P01BJGBST-K	87 €	
	P01BJGBSP		93 € 99 €
Argento	P01BJGBST-J	75 €	
	P01BJGBSP		80 € 86 €

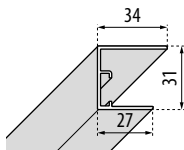

**KUADRA 2.0** H 200 cm

Finitura	Codice	Standard
Bianco opaco	P01BWMOST-U	111 €
Silver	P01BWMOST-B	120 €
Nero opaco	P01BWMOST-H	131 €
Cromo	P01BWMOST-K	131 €
Inox sp.	P01BWMOST-Z	158 €

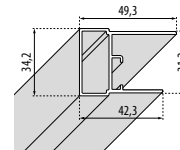

**KUADRA 2.0** H 200 cm  
In sostituzione del profilo a muro +15 mm

Finitura	Codice	Misure altezza	
		Standard	Speciale <200
Bianco opaco	P05BWMOST-U	103 €	
	P05BWMOSP		110 €
Silver	P05BWMOST-B	114 €	
	P05BWMOSP		122 €
Cromo	P05BWMOST-K	127 €	
	P05BWMOSP		136 €
Nero opaco	P05BWMOST-H	127 €	
	P05BWMOSP		136 €
Inox sp.	P05BWMOST-Z	152 €	
	P05BWMOSP		163 €

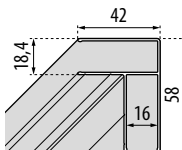

**LUNES STAR 2.0** H 195 cm

Finitura	Codice	Misure altezza	
		Standard	Speciale
Bianco	P05BJFST-A	64 €	
	P05BJFSP		68 € 73 €
Silver	P05BJFST-B	71 €	
	P05BJFSP		76 € 81 €
Cromo	P05BJFST-K	79 €	
	P05BJFSP		85 € 90 €
Argento	P05BJFST-J	68 €	
	P05BJFSP		73 € 78 €

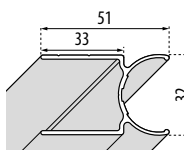

**YOUNG PLUS** H 200 cm

Finitura	Codice	Misure altezza	
		Standard	Speciale
Bianco	P0INCBMOST-U	60 €	
	P0INCBMOSP		64 €
Silver	P0INCBMOST-B	67 €	
	P0INCBMOSP		71 €
Cromo	P0INCBMOST-K	74 €	
	P0INCBMOSP		79 €
Nero opaco	P0INCBMOST-H	74 €	
	P0INCBMOSP		79 €
Inox	P0INCBMOST-Z	89 €	
	P0INCBMOSP		95 €

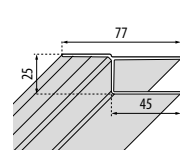

**KUADRA H** H 200 cm

Finitura	Codice	Standard
Bianco	P01KUHSTL-U	87 €
Silver	P01KUHSTL-B	97 €
Cromo	P01KUHSTL-K	108 €
Nero opaco	P01KUHSTL-H	108 €
Inox sp.	P01KUHSTL-Z	129 €

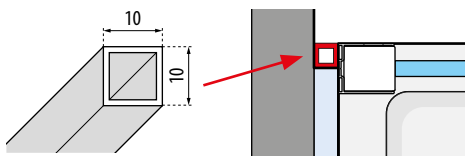

Finitura	Codice	Standard
		H. 200 CM
Bianco opaco	P10X10ST2-U	62 €
Silver	P10X10ST2-B	65 €
Cromo	P10X10ST2-K	72 €
Nero opaco	P10X10ST2-H	72 €
Argento	P10X10ST2-J	62 €
Inox sp.	P10X10ST2-Z	86 €

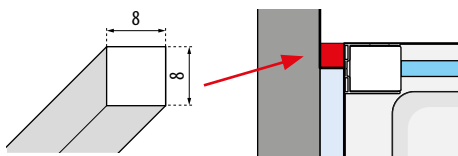

Finitura	Codice	Standard
		H. 200 CM
Bianco opaco	P08X08ST2-U	62 €
Silver	P08X08ST2-B	65 €
Cromo	P08X08ST2-K	72 €
Nero opaco	P08X08ST2-H	72 €
Argento	P08X08ST2-J	62 €
Inox sp.	P08X08ST2-Z	86 €

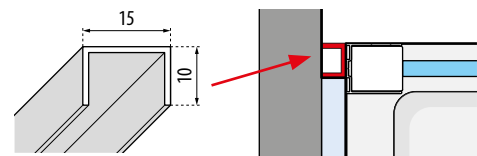

Finitura	Codice	Standard
		H. 200 CM
Bianco opaco	P51U1510ST2-U	81 €
Silver	P51U1510ST2-B	86 €
Cromo	P51U1510ST2-K	95 €
Nero opaco	P51U1510ST2-H	95 €
Argento	P51U1510ST2-J	82 €
Inox sp.	P51U1510ST2-Z	114 €

# SOLE TERMOARREDO IN CRISTALLO

**VETRO STRATIFICATO DI SICUREZZA** spessore 13 mm (6+1+6 mm)



I pannelli SOLE sono realizzati in vetro stratificato di sicurezza, con un livello di protezione IPX4. Quindi possono essere utilizzati anche nel bagno essendo protetti dagli spruzzi d'acqua.



## SOLE TELECOMANDO

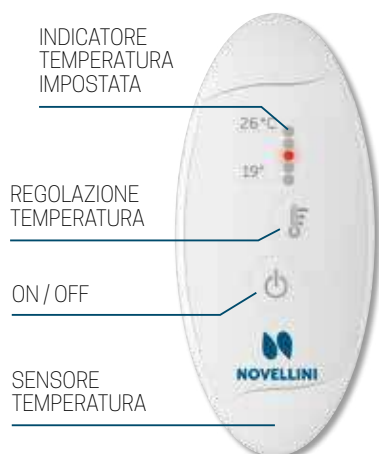

### NUOVA ELETTRONICA

con possibilità di installazione separata o collegata all'impianto di riscaldamento

### NUOVO SISTEMA DI RISPARMIO CONSUMO BATTERIE

# COME SCEGLIERE IL TUO TERMOARREDO?

1

## QUALE MISURA E POTENZA SCEGLIERE

La potenza necessaria è legata a diversi fattori quali la cubatura della stanza, la trasmittanza termica dell'edificio, o se viene usato in bagno a integrazione di un altro tipo di riscaldamento primario, ecc.

2

## CALCOLO INDICATIVO DELLA POTENZA

A → 2,70 mt. x  
 B → 1,90 mt. x  
 H → 2,70 mt. x  
**W/m<sup>3</sup>** → **50** =  
**Watt. 692**

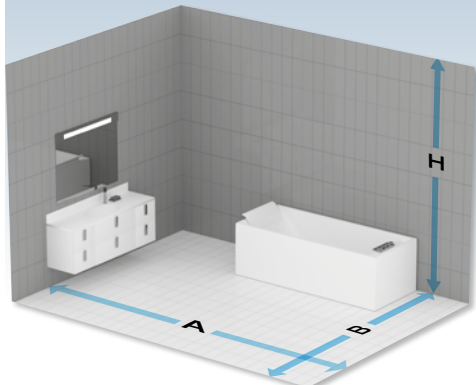

### 2A NECESSARIA IN RELAZIONE ALLE PRESTAZIONI TERMICHE DI UN FABBRICATO

	Trasmittanza termica edificio	Potenza necessaria in W/m <sup>3</sup> (Cubatura del locale)
Buona	0.3	30/40 W/m <sup>3</sup>
Sufficiente	0.5	40/50 W/m <sup>3</sup>
Scarsa	0.8	50/60 W/m <sup>3</sup>
Molto scarsa	1.0	60/100 W/m <sup>3</sup>

### 2B CALCOLO DELLA POTENZA DEL VOSTRO RADIATORE IN CRISTALLO

**A x B x H x W/m<sup>3</sup> =** Totale Watt necessari

**ATTENZIONE:** per una valutazione esatta delle calorie o watt necessari, si consiglia un consulto di un termotecnico che valuti nello specifico le varianti che potrebbero influire su questo calcolo come infissi, isolamento, muri, etc.

3

## POSIZIONE DEL TERMOARREDO (nella stanza da bagno)



Posizionare il termoarredo solo nella zona

③

(IEC 60364-7-701)  
(CEI 64 - 8/7)

CE



SOLE / DECORAZIONI DISPONIBILI



Codice **N0041**



Codice **T0011**



Codice **A0011**



Codice **R0021**



Codice **N0031**



Codice **T0211**



Codice **A0031**



Codice **T0241**



Codice **T0081**



Codice **T1410**

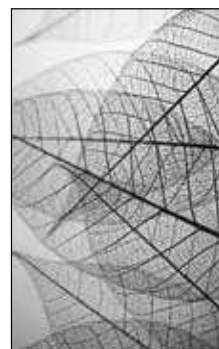

Codice **TA180**



Codice **T0071**



Codice **N0011**



Codice **T0171**



Codice **R0061**



Codice **FR020**



Codice **FR030**



Codice **FR040**



Codice **FR050**



Codice **GR020**

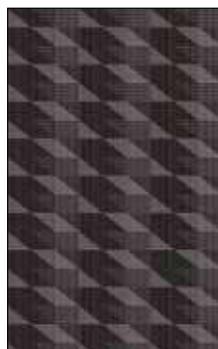

Codice **GR050**



Codice **GR060**



Codice **GR070**



Codice **IR010**





Codice **IR020**



Codice **IR030**

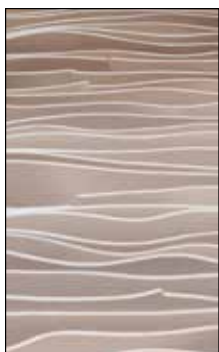

Codice **IR040**



Codice **IR050**



Codice **IR060**



Codice **A5021**



Codice **T5221**



Codice **R0071**

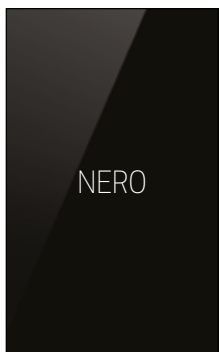

Codice **CA020**



Codice **CA010**



Codice **SA010**

In Art è un prodotto realizzato con colore fatto in polvere di vetro quindi la definizione non è di tipo fotografico e può essere soggetta a piccole variazioni cromatiche e di risoluzione

# SOLE MODELLI, CODICI ORDINE E PREZZI

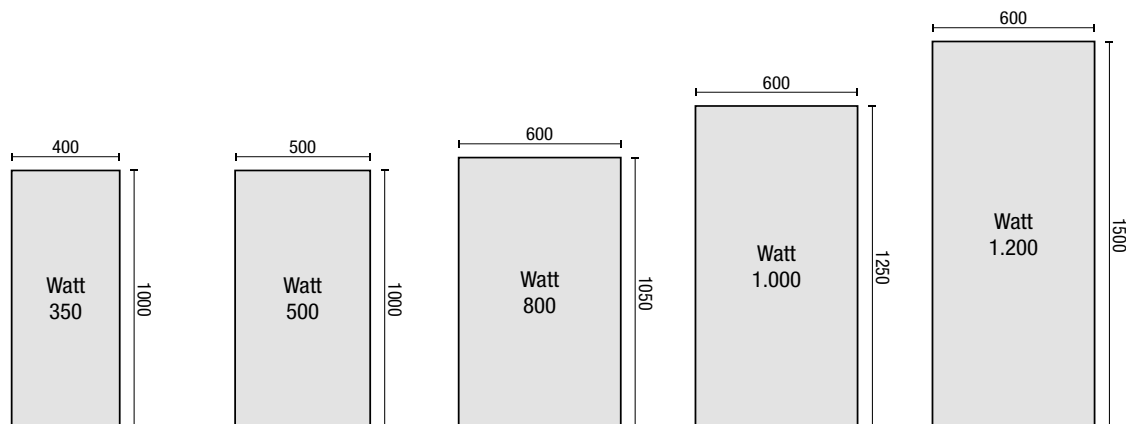

<b>Codice versione con telecomando</b>	<b>SOLT4010 -</b>	<b>SOLT5010 -</b>	<b>SOLT6010 -</b>	<b>SOLT6012 -</b>	<b>SOLT6015 -</b>
<b>Prezzo</b>	€ 1.074	€ 1.299	€ 1.523	€ 1.747	€ 1.972

Volt 220-230 - Hertz 50-60 Hz

Costruzione del codice:



# SOLE DISEGNI TECNICI

VERSIONE VERTICALE

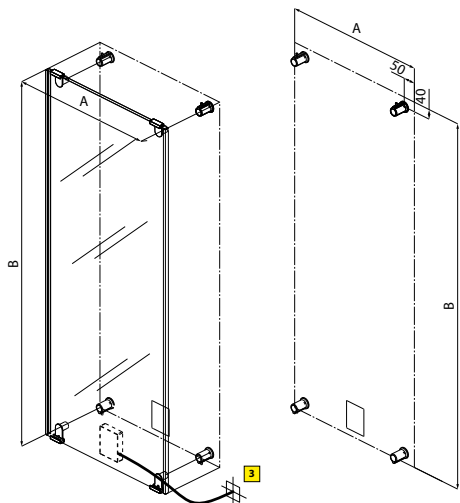

VERSIONE ORIZZONTALE

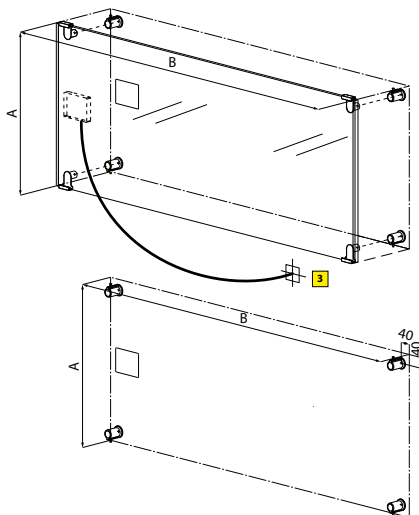

# SOLE CARATTERISTICHE TECNICHE

## PORTA SALVIETTE



### OPTIONAL PORTA SALVIETTE AGGIUNTIVO

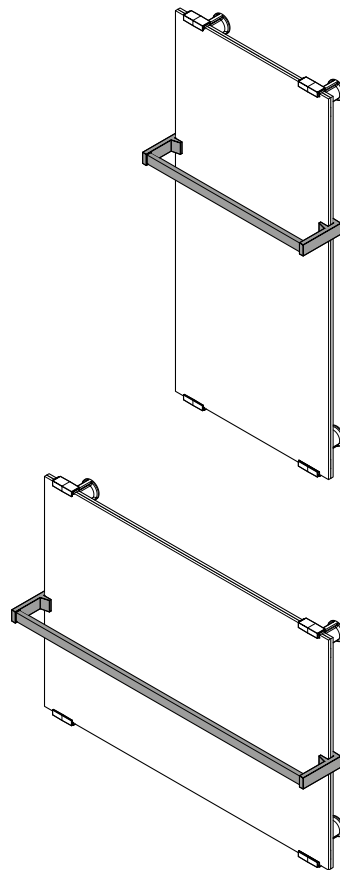

#### PER TERMOARREDO VERTICALE

Misure (mm)	Codice	Prezzo
400x1000	<b>R80SOLP40-K</b>	67 €
500x1000	<b>R80SOLP50-K</b>	67 €
600x1050	<b>R80SOLP60-K</b>	67 €
600x1250	<b>R80SOLP60-K</b>	67 €
600x1500	<b>R80SOLP60-K</b>	67 €

#### PER TERMOARREDO ORIZZONTALE

Misure (mm)	Codice	Prezzo
1000x400	<b>R80SOLP100-K</b>	74 €
1050x600	<b>R80SOLP105-K</b>	74 €
1250x600	<b>R80SOLP125-K</b>	84 €
1500x600	<b>R80SOLP150-K</b>	84 €

## FISSAGGIO A MURO

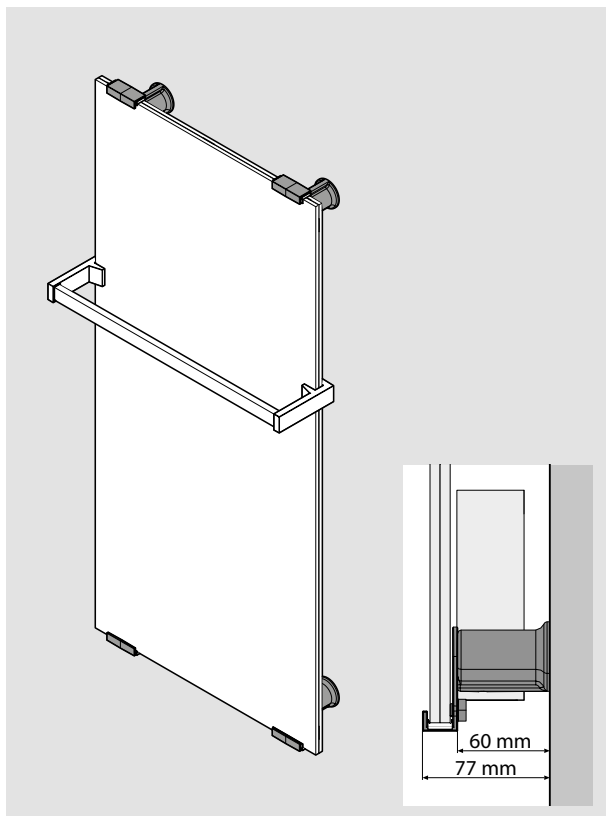

### STANDARD CROMO



### OPTIONAL

Descrizione	Codice	Prezzo
Nero	<b>R06SOL1-H</b>	17 €
Bianco	<b>R06SOL1-A</b>	17 €

Copertura fissaggio - 4 pezzi

### INSTALLAZIONE E POSIZIONAMENTO

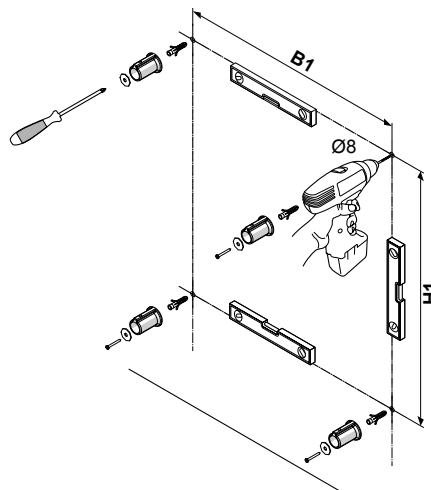

Misure (mm)	H1	B1
<b>400x1000</b>	921	300
<b>500x1000</b>	921	400
<b>600x1050</b>	971	500
<b>600x1250</b>	1171	500
<b>600x1500</b>	1421	500

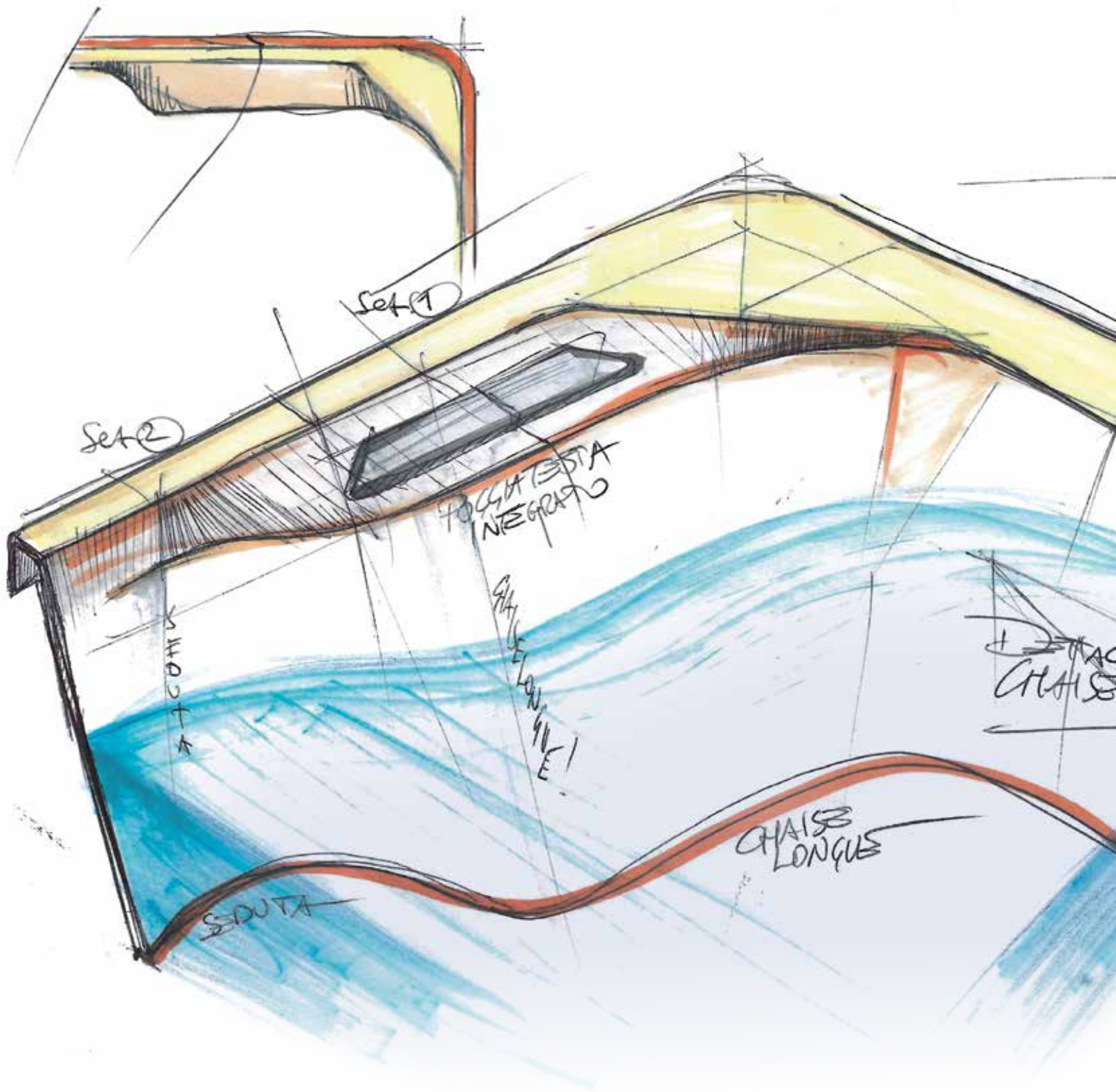

- 661 Moon
- 665 Divina M SPA
- 669 Divina L SPA
- 673 Divina XL SPA
- 677 Divina XXL SPA
- 681 Vita XL
- 685 Vita XXL
- 689 Complementi SPA

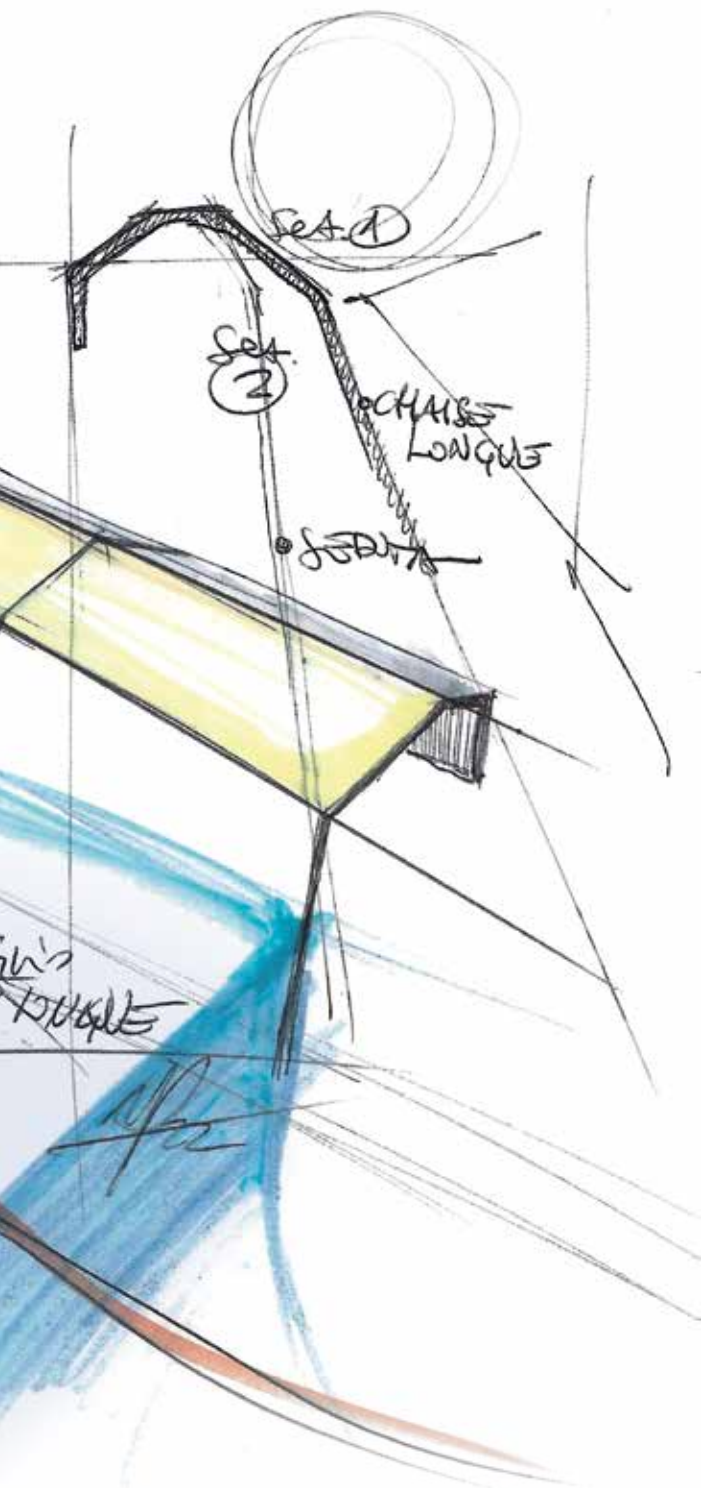

# OUTDOOR SPA

UN NUOVO SPAZIO  
DA SCOPRIRE  
E RIPROGETTARE  
PER IL TUO  
BENESSERE.

OUTDOOR SPA è la linea di prodotti wellness per esterno che interpreta perfettamente il nuovo concetto dell'abitare "everywhere". Che sia in una lounge in terrazza o in un ambiente relax a cielo aperto vicino alla stanza da letto, OUTDOOR SPA saprà dar forma ai tuoi spazi con un'estetica e con colori che si fondono in un ambiente unico contemporaneo, senza confini e dal carattere deciso.

Le vasche SPA sono dotate di specifici sistemi idromassaggio Whirlpool per un benessere totale, illuminazione bianca o Cromolight, audio Bluetooth e una serie di accessori che completano il confort del tuo spazio OUTDOOR.

OUTDOOR SPA, il rifugio per i tuoi sensi e per il tuo corpo da godere insieme a chi vuoi tu.



## MOON | FINITURE

### VASCA

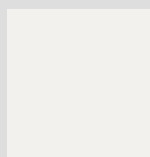

Bianco

### PANNELLI ARGILLA

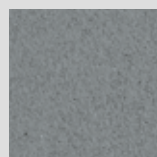

Cenere

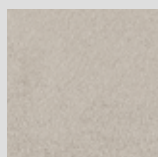

Polvere

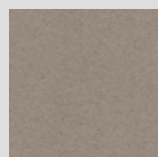

Tortora

### PANNELLI FIBER-CROSS

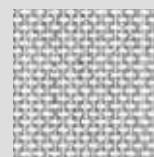

Light grey



Warm brown

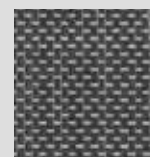

Steel

### PANNELLI NATURAL TOUCH

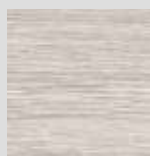

Oak Alpine



Oak Concrete

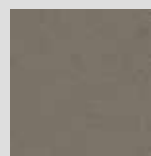

Oxid

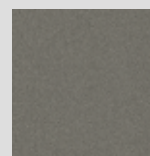

Quarz

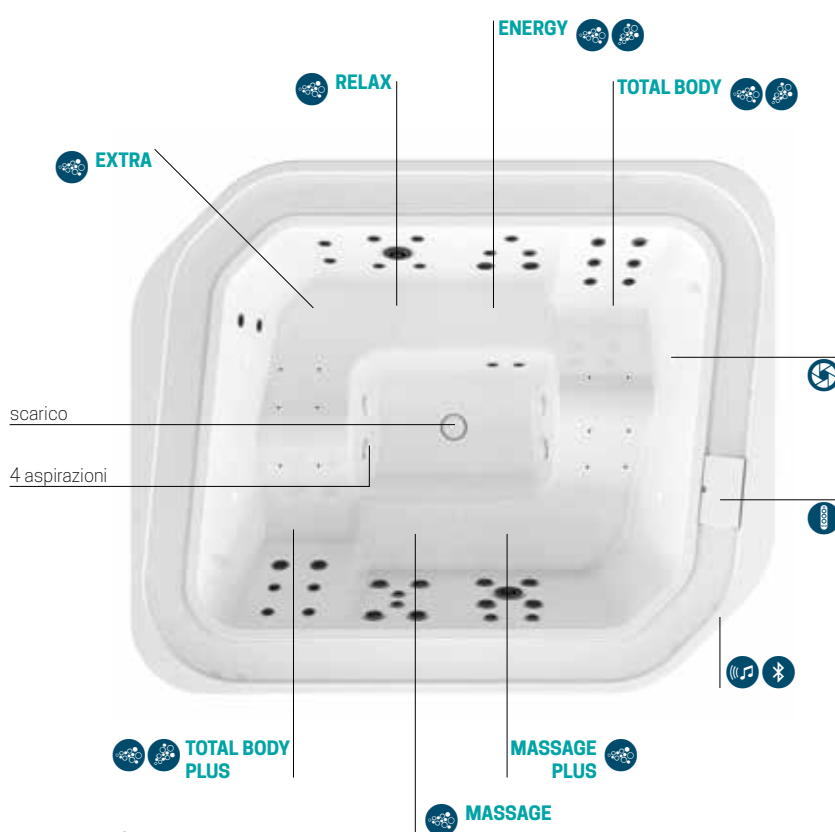

**Massaggio corpo Whirlpool** aria/acqua.  
Per soddisfare qualsiasi esigenza di benessere.



**Aquaclean** UV+Ozono



**4 Cromolight** con 8 variazioni cromatiche per attivare la mente ed emozionare lo spirito.



**Pannello di controllo**



**Diffusori audio bluetooth**  
4 interni e 4 esterni



Design by Simone Micheli



Pannello di controllo

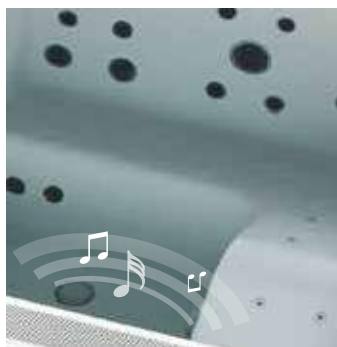

Sistema cromolight e audio



Griglia troppo pieno



Filtro a sabbia



# MOON

# MOON

MINIPISCINA MULTIFUNZIONE 215x260x93 - 1440 litri

Dimensioni cm 215 x 260 H 93

Posti 6+1

Capacità Lt. 1550

Codice	Scelta funzioni/Prezzo				Colori Vasca
	UV + Luci bianche	Aquaclean + Luci bianche	UV + Cromolight + audio Bluetooth *	Aquaclean + Cromolight + audio Bluetooth *	Bianco

## PLUS

	0X1	8X1	6X1	9X1	-W10K
<b>MOON40</b>	24.250 €	+ 650 €	+ 1.150 €	+ 1.750 €	

## PLUS CON SCAMBIATORE DI CALORE

	0R1	8R1	6R1	9R1	-W10K
<b>MOON40</b>	25.100 €	+ 650 €	+ 1.150 €	+ 1.750 €	

Costruzione del codice **Codice** + **Scelta funzioni/Prezzo** + **Colore vasca** = Codice prodotto finale

\* I TASTI AD AZIONAMENTO DIRETTO È INSTALLATO SOLO PER LE VERSIONI: 6X1, 9X1, 6R1 E 9R1

## PANNELLI

Codice	Scelta finitura pannelli/prezzo			
--------	---------------------------------	--	--	--

### PANNELLI NATURAL TOUCH

	P1	P2	P3	P4
				
	Oak-Alpine	Oak-Concrete	Oxid	Quarz
<b>PANV2F2LMOO-</b>	2.650 €	2.650 €	2.650 €	2.650 €

### PANNELLI ARGILLA

	R	O	S
			
	Cenere	Polvere	Tortora
<b>PANV2F2LMOO-</b>	4.000 €	4.000 €	4.000 €

### PANNELLI FIBER-CROSS

















	T1	T2	T3
			
	Light Grey	Warm Brown	Steel
<b>PATV2F2LMOO-</b>	3.000 €	3.000 €	3.000 €

662  Costruzione del codice **Codice** + **Scelta pannelli** = Codice prodotto finale



## FUNZIONI

## PLUS

	Whirlpool jets	41
	Whirlpool mini jets	12
	Sistema di purificazione Aquaclean (UV+ozono)	OPTIONAL
	Sistema di purificazione UV	●
	4 Luce led bianca	●
	5 Chromolight	OPTIONAL
	Sistema audio integrato + bluetooth	OPTIONAL
	Modulo Wi-Fi	OPTIONAL
	2 Pompe a singola velocità	●
	Pompa di ricircolo	●
	Riscaldatore 3 kW	●
	Scambiatore di calore	OPTIONAL
	Riempimento automatico	●
	Serbatoio di compenso	●
	Svuotamento rapido	●
	Filtro a sabbia	●
	Tasto ad azionamento diretto *	OPTIONAL

### MODULO WI-FI

Codice	Prezzo
<b>DOMOWF</b>	450 €

### KIT COIBENTAZIONE FONDO VASCA

Codice	Prezzo
<b>MOTHCOFV</b>	500 €

### KIT COIBENTAZIONE PANNELLI

Coibentazione	Codice	Prezzo
KIT OPZIONALE PER CLIMI RIGIDI	<b>KBT2F2LM00</b>	525 €

### COPERTURA TERMICA

Coibentazione	Codice	Prezzo	
		C1	C2
		Plenty Grey	Brown
Copertura Estiva	<b>MOTHCO-</b>	1.990 €	1.990 €
Copertura Invernale	<b>MOTHCOT-</b>	2.290 €	2.290 €

## VERSIONE PLUS

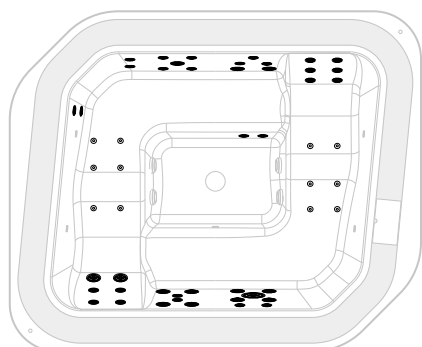



## DIVINA M SPA | FINITURE

### VASCA

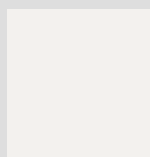

Bianco

### PANNELLI DOGATI

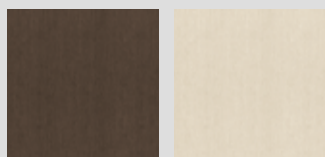

Dark brown

Ice

### SEDUTA E POGGIATESTA

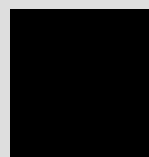

Nero



Light grey



Warm brown

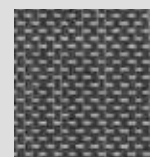

Steel

Fiber-Cross

### PANNELLI NATURAL TOUCH



Oak Alpine



Oak Concrete

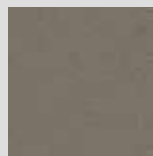

Oxid

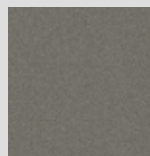

Quarz

### PANNELLI FIBER-CROSS

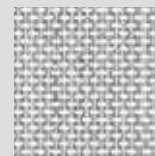

Light grey



Warm brown

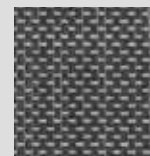

Steel

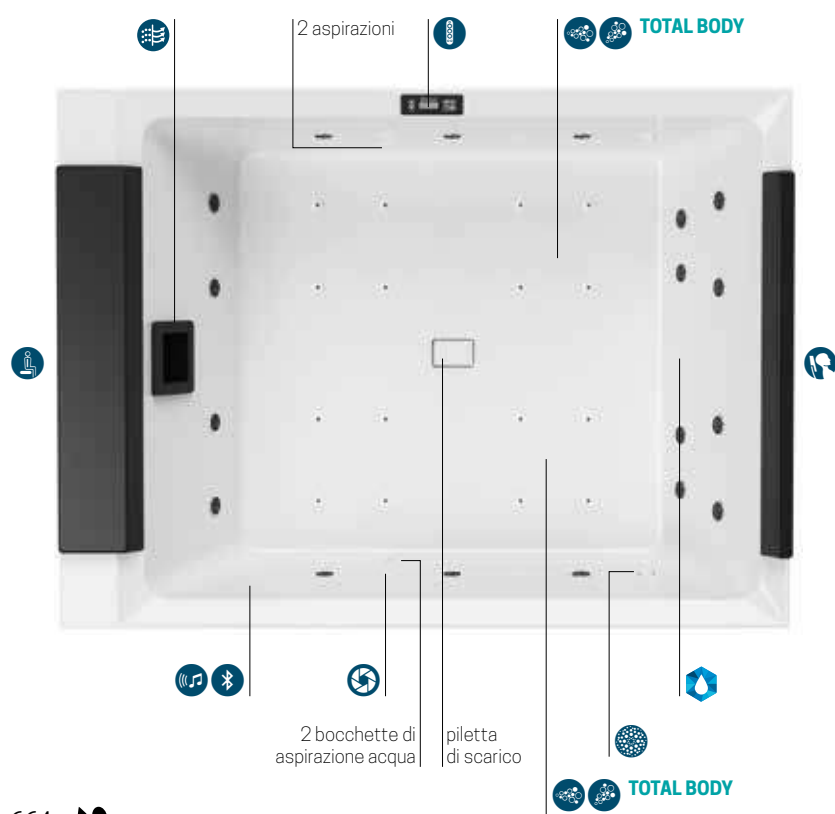

**Massaggio Airpool** a getto d'aria con accensione manuale on/off. Per una **efficace stimolazione cellulare**.



**Massaggio corpo Whirlpool** aria/acqua con regolazione di tempo e intensità manuale o automatica. Per soddisfare qualsiasi esigenza di benessere.



**Skimmer filtro acqua**



**Aquaclean UV+Ozono**



**2 Natural air**



**4 Cromolight** con 8 variazioni cromatiche per attivare la mente ed emozionare lo spirito.



**Pannello di controllo**



**Poggiatesta** in materiale antibatterico.



**Seduta** con comando piletta



**Diffusori audio bluetooth**  
2 interni e 2 esterni



VASCA BIANCO MORBIDO CON LUCE LED ESTERNA



Pannello di controllo

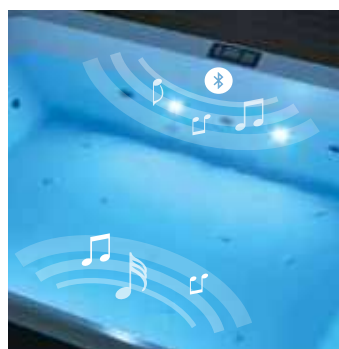

Sistema cromolight e audio



Natural Air



Sistema di purificazione acqua  
Aquaclean



# DIVINA M SPA

# DIVINA M SPA

MINIPISCINA MULTIFUNZIONE 190x140x75 - 500 litri

Dimensioni cm 190x140 H 75

Posti 2

Capacità Lt. 550

Codice	Scelta funzioni/Prezzo						Scelta riempimento		Colori Vasca	Colori sedile e poggiatesta			
	Standard + luci led bianche	UV + luci led bianche	Aquaclean + luci led bianche	Cromolight + audio Bluetooth	UV + Cromolight + audio Bluetooth	Aquaclean + Cromolight + audio Bluetooth	SENZA Riempimento Automatico	CON Riempimento Automatico		Bianco Lucido	Nero	Light Grey	Warm Brown

STANDARD													
	0X	3X	8X	6X	4X	9X	0	1	-A0	H	T1	T2	T3
DOM50	10.875 €	+ 600 €	+ 1.250 €	+ 900 €	+ 1.500 €	+ 2.150 €		+ 425 €			+ 600 €	+ 600 €	+ 600 €

STANDARD CON SCAMBIATORE DI CALORE													
	0R	3R	8R	6R	4R	9R	0	1	-A0	H	T1	T2	T3
DOM50	11.725 €	+ 600 €	+ 1.250 €	+ 900 €	+ 1.500 €	+ 2.150 €		+ 425 €			+ 600 €	+ 600 €	+ 600 €

PLUS													
	0X	3X	8X	6X	4X	9X	0	1	-A0	H	T1	T2	T3
DOM40	12.875 €	+ 600 €	+ 1.250 €	+ 900 €	+ 1.500 €	+ 2.150 €		+ 425 €			+ 600 €	+ 600 €	+ 600 €

PLUS CON SCAMBIATORE DI CALORE													
	0R	3R	8R	6R	4R	9R	0	1	-A0	H	T1	T2	T3
DOM40	13.725 €	+ 600 €	+ 1.250 €	+ 900 €	+ 1.500 €	+ 2.150 €		+ 425 €			+ 600 €	+ 600 €	+ 600 €

PLUS+NATURAL AIR													
	0X	3X	8X	6X	4X	9X	0	1	-A0	H	T1	T2	T3
DOMPO	15.375 €	+ 600 €	+ 1.250 €	+ 900 €	+ 1.500 €	+ 2.150 €		+ 425 €			+ 600 €	+ 600 €	+ 600 €

PLUS+NATURAL AIR CON SCAMBIATORE DI CALORE													
	0R	3R	8R	6R	4R	9R	0	1	-A0	H	T1	T2	T3
DOMPO	16.225 €	+ 600 €	+ 1.250 €	+ 900 €	+ 1.500 €	+ 2.150 €		+ 425 €			+ 600 €	+ 600 €	+ 600 €

Costruzione del codice **Codice** + **Scelta funzioni** + **Colore vasca** + **Colore seduta poggiatesta** = Codice prodotto finale

## PANNELLI

Codice	Scelta finitura pannelli/prezzo			
PANNELLI NATURAL TOUCH				
	P1	P2	P3	P4
				
	Oak-Alpine	Oak-Concrete	Oxid	Quarz
PANV2F2LDIVDO-	1.800 €	1.800 €	1.800 €	1.800 €

PANNELLI DOGATI		
	D1	D2
		
	Dark Brown	Ice
PADV2F2LDIVDO-	1.300 €	1.300 €

PANNELLI FIBER-CROSS			
	T1	T2	T3
			
	Light Grey	Warm Brown	Steel
PATV2F2LDIVDO-	2.100 €	2.100 €	2.100 €

666  Costruzione del codice **Codice** + **Scelta pannelli** = Codice prodotto finale

FUNZIONI	STANDARD	PLUS	PLUS+NATURAL AIR
Whirlpool jets	18	18	18
Whirlpool mini jets	-	16	16
Natural Air	-	-	2
Sistema di purificazione Aquaclean (UV+ozono)	OPTIONAL	OPTIONAL	OPTIONAL
Sistema di purificazione UV	OPTIONAL	OPTIONAL	OPTIONAL
4 Luce led bianca	●	●	●
4 Chromolight	OPTIONAL	OPTIONAL	OPTIONAL
Poggiatesta	OPTIONAL	OPTIONAL	OPTIONAL
Sistema audio integrato + bluetooth	OPTIONAL	OPTIONAL	OPTIONAL
Modulo Wi-Fi	OPTIONAL	OPTIONAL	OPTIONAL
Pompa a doppia velocità	●	●	●
Skimmer filtro acqua	●	●	●
Riscaldatore 2 kW	●	●	●
Scambiatore di calore	OPTIONAL	OPTIONAL	OPTIONAL
Riempimento automatico	OPTIONAL	OPTIONAL	OPTIONAL

MODULO WI-FI	
Codice	Prezzo
<b>DOMOWF</b>	450 €

KIT COIBENTAZIONE FONDO VASCA	
Codice	Prezzo
<b>DOTHCOFV</b>	225 €

KIT COIBENTAZIONE PANNELLI	
Codice	Prezzo
<b>KBT2F2LDOM</b>	325 €

COPERTURA TERMICA			
Coibentazione	Codice	Prezzo	
		C1	C2
		Plenty Grey	Brown
Copertura Estiva	<b>DOTHCO-</b>	1.200 €	1.200 €
Copertura Invernale	<b>DOTHCOT-</b>	1.500 €	1.500 €

VERSIONE **STANDARD**

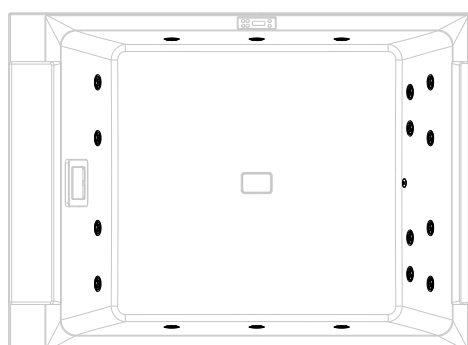

VERSIONE **PLUS**

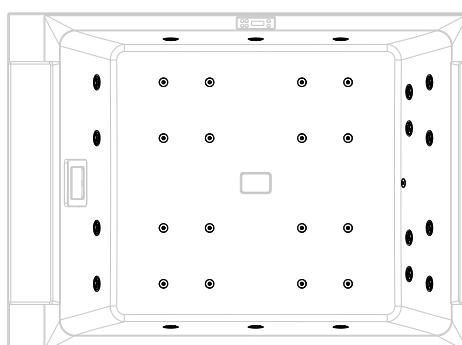

VERSIONE **PLUS+NATURAL AIR**

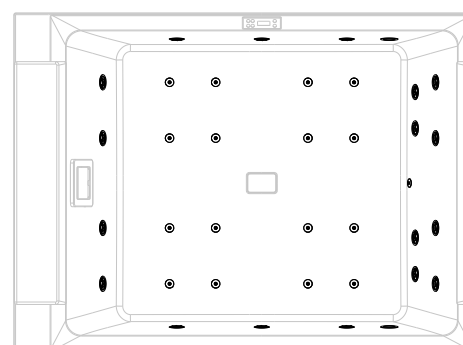



## DIVINA L SPA | FINITURE

### VASCA

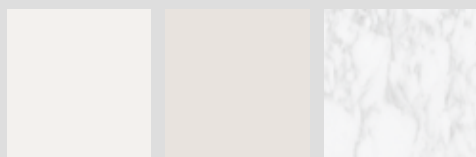

Bianco

Perla

Marmo chiaro

### SEDUTA E POGGIATESTA



Nero

Light grey

Warm brown

Steel

Fiber-Cross

### PANNELLI NATURAL TOUCH

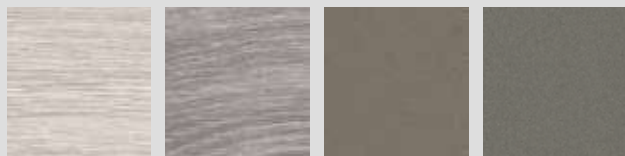

Oak Alpine

Oak Concrete

Oxid

Quarz

### PANNELLI DOGATI

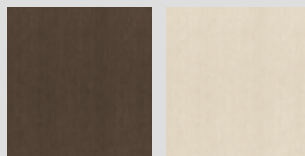

Dark brown

Ice

### PANNELLI FIBER-CROSS



Light grey

Warm brown

Steel



**Massaggio Airpool** a getto d'aria con accensione manuale on/off. Per una **efficace stimolazione cellulare**.



**Massaggio corpo Whirlpool** aria/acqua con regolazione di tempo e intensità manuale o automatica. Per soddisfare qualsiasi esigenza di benessere.



**Skimmer filtro acqua**



**Aquaclean UV+Ozono**



**4 Cromolight** con 8 variazioni cromatiche per attivare la mente ed emozionare lo spirito.



**Pannello di controllo**



**Poggiatesta** in materiale antibatterico.



**Seduta** con soft closing pannello di controllo regolatori aria



**Diffusori audio bluetooth**  
2 interni e 2 esterni



Pannello di controllo

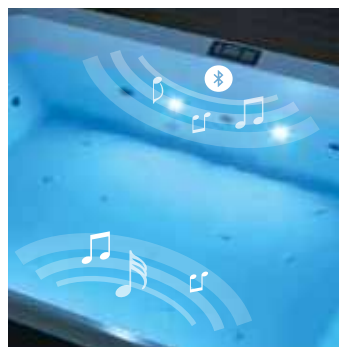

Sistema cromolight e audio



Sistema di purificazione acqua Aquaclean



Jet ad alta efficienza massaggiante



# DIVINA L SPA

# DIVINA L SPA

MINIPISCINA MULTIFUNZIONE 185x160x85 - 680 litri

Dimensioni cm 185 x 160 H 85

Posti 3

Capacità Lt. 680

Codice	Scelta funzioni/Prezzo						Scelta riempimento		Colori Vasca			Colori sedile e poggiatesta			
	Standard + luci led bianche	UV + luci led bianche	Aquaclean + luci led bianche	Cromolight + audio Bluetooth	UV + Cromolight + audio Bluetooth	Aquaclean + Cromolight + audio Bluetooth	SENZA Riempimento Automatico	CON Riempimento Automatico	Bianco	Perla	Marmo chiaro	Nero	Light Grey	Warm Brown	Steel

STANDARD															
	0X	3X	8X	6X	4X	9X	0	1	-W10	-W20	-W30	H	T1	T2	T3
DOL50	11.500 €	+ 600 €	+ 1.250 €	+ 900 €	+ 1.500 €	+ 2.150 €		+ 425 €		+ 250 €	+ 150 €	-	-	-	-

STANDARD CON SCAMBIATORE DI CALORE															
	0R	3R	8R	6R	4R	9R	0	1	-W10	-W20	-W30	H	T1	T2	T3
DOL50	12.350 €	+ 600 €	+ 1.250 €	+ 900 €	+ 1.500 €	+ 2.150 €		+ 425 €		+ 250 €	+ 150 €	-	-	-	-



PLUS															
	0X	3X	8X	6X	4X	9X	0	1	-W10	-W20	-W30	H	T1	T2	T3
DOL40	13.000 €	+ 600 €	+ 1.250 €	+ 900 €	+ 1.500 €	+ 2.150 €		+ 425 €		+ 250 €	+ 150 €		+ 600 €	+ 600 €	+ 600 €

PLUS CON SCAMBIATORE DI CALORE															
	0R	3R	8R	6R	4R	9R	0	1	-W10	-W20	-W30	H	T1	T2	T3
DOL40	13.850 €	+ 600 €	+ 1.250 €	+ 900 €	+ 1.500 €	+ 2.150 €		+ 425 €		+ 250 €	+ 150 €		+ 600 €	+ 600 €	+ 600 €

Costruzione del codice **Codice** + **Scelta funzioni** + **Colore vasca** + **Colore seduta poggiatesta** = Codice prodotto finale

## PANNELLI

Codice	Scelta finitura pannelli/prezzo			
PANNELLI NATURAL TOUCH				
	P1	P2	P3	P4
				
	Oak-Alpine	Oak-Concrete	Oxid	Quarz
PANV2F2LDIVDL-	2.200 €	2.200 €	2.200 €	2.200 €

PANNELLI DOGATI		
	D1	D2
		
	Dark Brown	Ice
PADV2F2LDIVDL-	1.425 €	1.425 €

PANNELLI FIBER-CROSS			
	T1	T2	T3
			
	Light Grey	Warm Brown	Steel
PATV2F2LDIVDL-	2.400 €	2.400 €	2.400 €

670  Costruzione del codice **Codice** + **Scelta pannelli** = Codice prodotto finale



FUNZIONI	STANDARD	PLUS
Whirlpool mini jets	4	6
Whirlpool jets	12	18
2 Luce led bianca	●	●
2 Chromolight	OPTIONAL	OPTIONAL
Poggiatesta	-	●
Sistema audio integrato + bluetooth	OPTIONAL	OPTIONAL
Modulo Wi-Fi	OPTIONAL	OPTIONAL
Sistema di purificazione Aquaclean (UV+ozono)	OPTIONAL	OPTIONAL
Sistema di purificazione UV	OPTIONAL	OPTIONAL
Pompa a doppia velocità	●	●
Riscaldatore 2 kW	●	●
Scambiatore di calore	OPTIONAL	OPTIONAL
Riempimento automatico	OPTIONAL	OPTIONAL

MODULO WI-FI	
Codice	Prezzo
<b>DOMOWF</b>	450 €

KIT COIBENTAZIONE FONDO VASCA	
Codice	Prezzo
<b>DLTHCOFV</b>	250 €

KIT COIBENTAZIONE PANNELLI	
Codice	Prezzo
<b>KBT2F2LDOL</b>	350 €

COPERTURA TERMICA			
Coibentazione	Codice	Prezzo	
		C1	C2
		Plenty Grey	Brown
Copertura Estiva	<b>DLTHCO-</b>	1.300 €	1.300 €
Copertura Invernale	<b>DLTHCOT-</b>	1.600 €	1.600 €

#### VERSIONE **STANDARD**

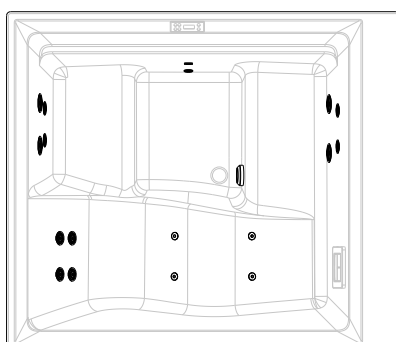

#### VERSIONE **PLUS**

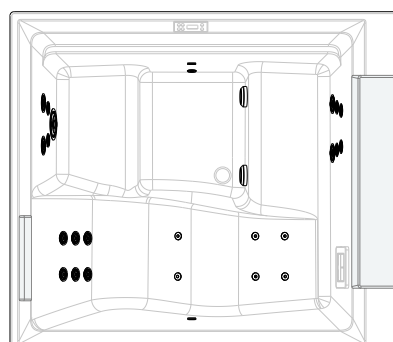



## DIVINA XL SPA | FINITURE

### VASCA

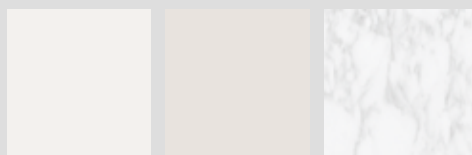

Bianco

Perla

Marmo chiaro

### SEDUTA E POGGIATESTA



Nero

Light grey

Warm brown

Steel

Fiber-Cross

### PANNELLI NATURAL TOUCH

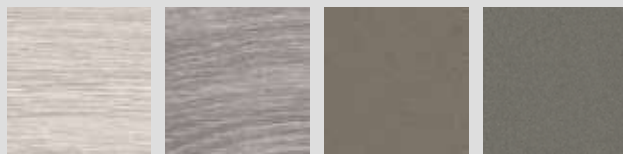

Oak Alpine

Oak Concrete

Oxid

Quarz

### PANNELLI DOGATI

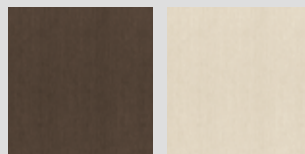

Dark brown

Ice

### PANNELLI FIBER-CROSS



Light grey

Warm brown

Steel

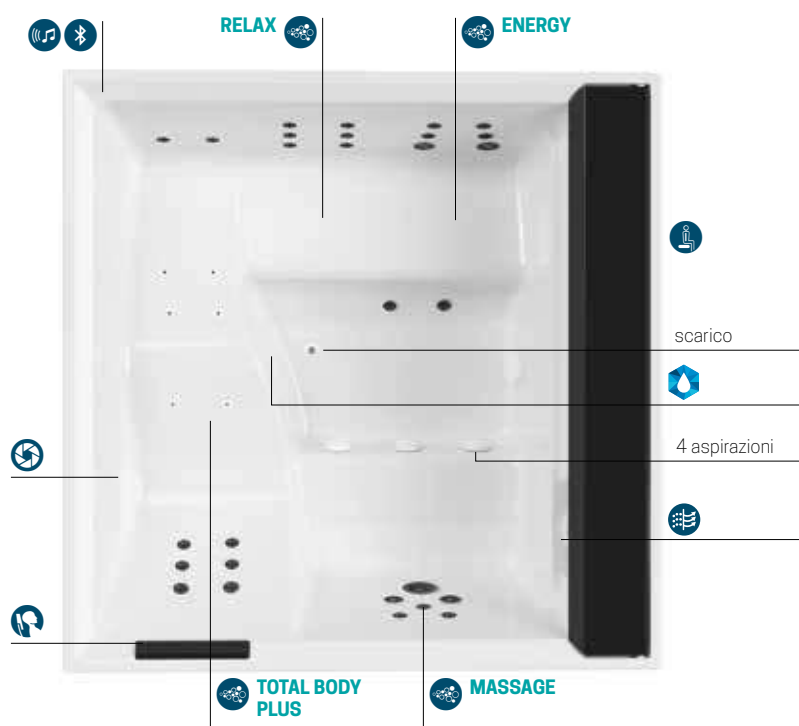

**Massaggio Airpool** a getto d'aria con accensione manuale on/off. Per una **efficace stimolazione cellulare**.



**Massaggio corpo Whirlpool** aria/acqua con regolazione di tempo e intensità manuale o automatica. Per soddisfare qualsiasi esigenza di benessere.



**Skimmer filtro acqua**



**Aquaclean UV+Ozono**



**4 Cromolight** con 8 variazioni cromatiche per attivare la mente ed emozionare lo spirito.



**Pannello di controllo**



**Poggiatesta** in materiale antibatterico.



**Seduta** con soft closing pannello di controllo regolatori aria



**Diffusori audio bluetooth**  
4 interni e 4 esterni



Pannello di controllo

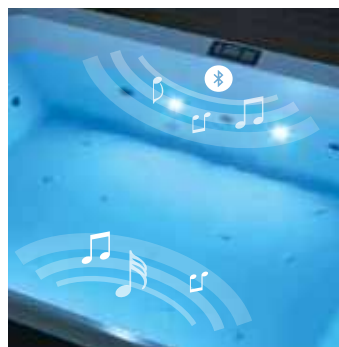

Sistema cromolight e audio



Sistema di purificazione acqua  
AquaClean



Sedile accesso vasca, con  
chiusura rallentata



# DIVINA XL SPA

# DIVINA XL SPA

MINIPISCINA MULTIFUNZIONE 200x200x85 - 930 litri

Dimensioni cm 200 x 200 H 85

Posti 4

Capacità Lt. 930

Codice	Scelta funzioni/Prezzo				Scelta riempimento		Colori Vasca			Colori sedile e poggiatesta			
	Standard + luci led bianche	Aquaclean + luci led bianche	Cromolight + audio Bluetooth	Aquaclean + Cromolight + audio Bluetooth	SENZA Riempimento Automatico	CON Riempimento Automatico							
<b>STANDARD</b>													
	<b>0X</b>	<b>8X</b>	<b>6X</b>	<b>9X</b>	<b>0</b>	<b>1</b>	<b>-W10</b>	<b>-W20</b>	<b>-W30</b>	<b>H</b>	<b>T1</b>	<b>T2</b>	<b>T3</b>
<b>DOXL50</b>	14.750 €	+ 650 €	+ 1.050 €	+ 1.650 €		+ 425 €		+ 275 €	+ 175 €		+ 800 €	+ 800 €	+ 800 €
<b>STANDARD CON SCAMBIATORE DI CALORE</b>													
	<b>0R</b>	<b>8R</b>	<b>6R</b>	<b>9R</b>	<b>0</b>	<b>1</b>	<b>-W10</b>	<b>-W20</b>	<b>-W30</b>	<b>H</b>	<b>T1</b>	<b>T2</b>	<b>T3</b>
<b>DOXL50</b>	15.600 €	+ 650 €	+ 1.050 €	+ 1.650 €		+ 425 €		+ 275 €	+ 175 €		+ 800 €	+ 800 €	+ 800 €
<b>PLUS</b>													
	<b>0X</b>	<b>8X</b>	<b>6X</b>	<b>9X</b>	<b>0</b>	<b>1</b>	<b>-W10</b>	<b>-W20</b>	<b>-W30</b>	<b>H</b>	<b>T1</b>	<b>T2</b>	<b>T3</b>
<b>DOXL40</b>	18.000 €	+ 650 €	+ 1.050 €	+ 1.650 €		+ 425 €		+ 275 €	+ 175 €		+ 800 €	+ 800 €	+ 800 €
<b>PLUS CON SCAMBIATORE DI CALORE</b>													
	<b>0R</b>	<b>8R</b>	<b>6R</b>	<b>9R</b>	<b>0</b>	<b>1</b>	<b>-W10</b>	<b>-W20</b>	<b>-W30</b>	<b>H</b>	<b>T1</b>	<b>T2</b>	<b>T3</b>
<b>DOXL40</b>	18.850 €	+ 650 €	+ 1.050 €	+ 1.650 €		+ 425 €		+ 275 €	+ 175 €		+ 800 €	+ 800 €	+ 800 €

Costruzione del codice **Codice** + **Scelta funzioni** + **Colore vasca** + **Colore seduta poggiatesta** = Codice prodotto finale

## PANNELLI

Codice	Scelta finitura pannelli/prezzo			
<b>PANNELLI NATURAL TOUCH</b>				
	<b>P1</b>	<b>P2</b>	<b>P3</b>	<b>P4</b>
<b>PANV2F2LDIVDX-</b>	Oak-Alpine 2.350 €	Oak-Concrete 2.350 €	Oxid 2.350 €	Quarz 2.350 €
<b>PANNELLI DOGATI</b>				
	<b>D1</b>	<b>D2</b>		
<b>PADV2F2LDIVDX-</b>	Dark Brown 1.575 €	Ice 1.575 €		
<b>PANNELLI FIBER-CROSS</b>				
	<b>T1</b>	<b>T2</b>	<b>T3</b>	
<b>PATV2F2LDIVDX-</b>	Light Grey 2.600 €	Warm Brown 2.600 €	Steel 2.600 €	

FUNZIONI	STANDARD	PLUS
whirlpool mini jets	4	6
whirlpool jets	18	28
4 Luce led bianca	●	●
4 Chromolight	OPTIONAL	OPTIONAL
Poggiatesta	-	●
Sistema audio stereo + bluetooth	OPTIONAL	OPTIONAL
Modulo Wi-Fi	OPTIONAL	OPTIONAL
Sistema di purificazione Aquaclean (UV+ozono)	OPTIONAL	OPTIONAL
Sistema di purificazione UV	●	●
Pompa a singola velocità	-	●
Pompa a doppia velocità	●	●
Riscaldatore 3 kW	●	●
Scambiatore di calore	OPTIONAL	OPTIONAL
Riempimento automatico	OPTIONAL	OPTIONAL

MODULO WI-FI	
Codice	Prezzo
<b>DOMOWF</b>	450 €

KIT COIBENTAZIONE FONDO VASCA	
Codice	Prezzo
<b>DXTHCOFV</b>	375 €

KIT COIBENTAZIONE PANNELLI	
Codice	Prezzo
<b>KBT2F2LDOXL</b>	425 €

COPERTURA TERMICA			
Coibentazione	Codice	Prezzo	
		C1	C2
		Plenty Grey	Brown
Copertura Estiva	<b>DXTHCO-</b>	1.400 €	1.400 €
Copertura Invernale	<b>DXTHCOT-</b>	1.700 €	1.700 €

#### VERSIONE STANDARD

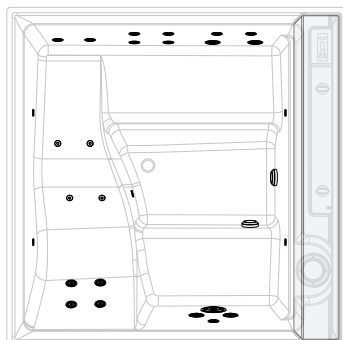

#### VERSIONE PLUS

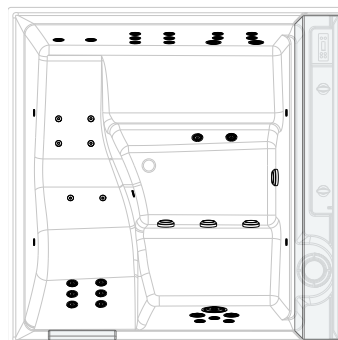



## DIVINA XXL SPA | FINITURE

### VASCA

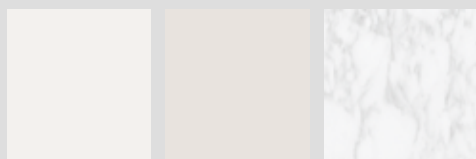

Bianco

Perla

Marmo chiaro

### SEDUTA E POGGIATESTA



Nero

Light grey

Warm brown

Steel

Fiber-Cross

### PANNELLI NATURAL TOUCH

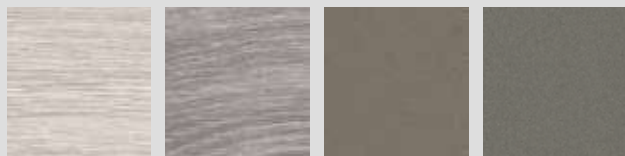

Oak Alpine

Oak Concrete

Oxid

Quarz

### PANNELLI DOGATI

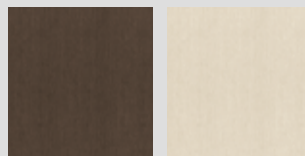

Dark brown

Ice

### PANNELLI FIBER-CROSS



Light grey

Warm brown

Steel

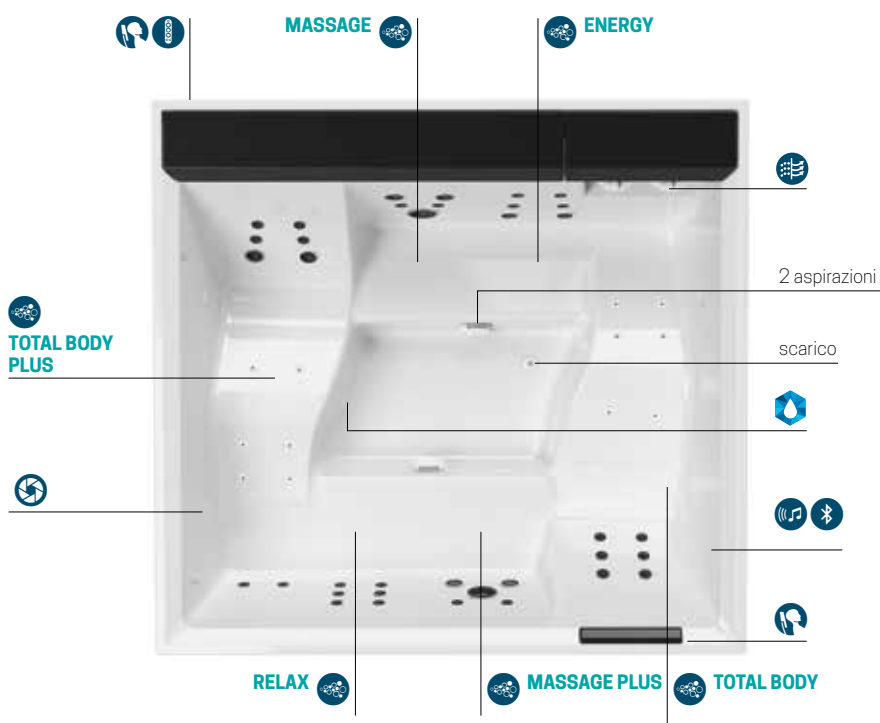

**Massaggio Airpool** a getto d'aria con accensione manuale on/off. Per una **efficace stimolazione cellulare**.



**Massaggio corpo Whirlpool** aria/acqua con regolazione di tempo e intensità manuale o automatica. Per soddisfare qualsiasi esigenza di benessere.



**Skimmer filtro acqua**



**Aquaclean UV+Ozono**



**4 Cromolight** con 8 variazioni cromatiche per attivare la mente ed emozionare lo spirito.



**Pannello di controllo**



**Poggiatesta** in materiale antibatterico.



**Seduta** con soft closing pannello di controllo regolatori aria



**Diffusori audio bluetooth**  
4 interni e 4 esterni



Pannello di controllo

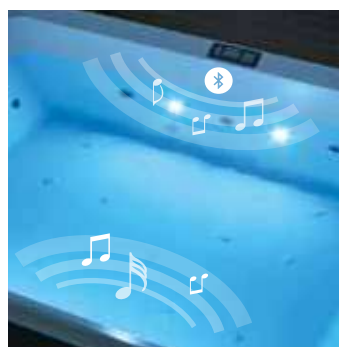

Sistema cromolight e audio



Sistema di purificazione acqua  
Aquaclean

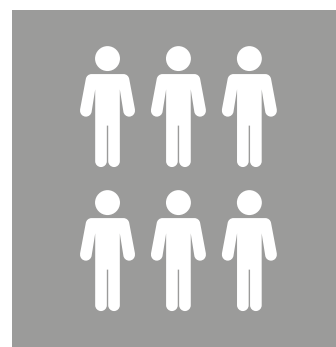

Vasca 6 posti



# DIVINA XXL SPA

# DIVINA XXL SPA

MINIPISCINA MULTIFUNZIONE 230x215x85 - 1160 litri

Dimensioni cm 230 x 215 H 85









Posti 6

Capacità Lt. 1160

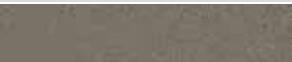
Codice	Scelta funzioni/Prezzo				Scelta riempimento		Colori Vasca			Colori sedile e poggiatesta			
	Standard + luci led bianche	Aquaclean + luci led bianche	Cromolight + audio Bluetooth	Aquaclean + Cromolight + audio Bluetooth	SENZA Riempimento Automatico	CON Riempimento Automatico							
							Bianco	Perla	Marmo chiaro	Nero	Light Grey	Warm Brown	Steel
<b>STANDARD</b>													
	<b>0X</b>	<b>8X</b>	<b>6X</b>	<b>9X</b>	<b>0</b>	<b>1</b>	<b>-W10</b>	<b>-W20</b>	<b>-W30</b>	<b>H</b>	<b>T1</b>	<b>T2</b>	<b>T3</b>
<b>DOXXL50</b>	18.500 €	+ 650 €	+ 1.050 €	+ 1.650 €		+ 425 €		+ 300 €	+ 200 €		+ 1.000 €	+ 1.000 €	+ 1.000 €
<b>STANDARD CON SCAMBIATORE DI CALORE</b>													
	<b>0R</b>	<b>8R</b>	<b>6R</b>	<b>9R</b>	<b>0</b>	<b>1</b>	<b>-W10</b>	<b>-W20</b>	<b>-W30</b>	<b>H</b>	<b>T1</b>	<b>T2</b>	<b>T3</b>
<b>DOXXL50</b>	19.350 €	+ 650 €	+ 1.050 €	+ 1.650 €		+ 425 €		+ 300 €	+ 200 €		+ 1.000 €	+ 1.000 €	+ 1.000 €
<b>PLUS</b>													
	<b>0X</b>	<b>8X</b>	<b>6X</b>	<b>9X</b>	<b>0</b>	<b>1</b>	<b>-W10</b>	<b>-W20</b>	<b>-W30</b>	<b>H</b>	<b>T1</b>	<b>T2</b>	<b>T3</b>
<b>DOXXL40</b>	21.750 €	+ 650 €	+ 1.050 €	+ 1.650 €		+ 425 €		+ 300 €	+ 200 €		+ 1.000 €	+ 1.000 €	+ 1.000 €
<b>PLUS CON SCAMBIATORE DI CALORE</b>													
	<b>0R</b>	<b>8R</b>	<b>6R</b>	<b>9R</b>	<b>0</b>	<b>1</b>	<b>-W10</b>	<b>-W20</b>	<b>-W30</b>	<b>H</b>	<b>T1</b>	<b>T2</b>	<b>T3</b>
<b>DOXXL40</b>	22.600 €	+ 650 €	+ 1.050 €	+ 1.650 €		+ 425 €		+ 300 €	+ 200 €		+ 1.000 €	+ 1.000 €	+ 1.000 €

Costruzione del codice **Codice** + **Scelta funzioni** + **Colore vasca** + **Colore seduta poggiatesta** = Codice prodotto finale

## PANNELLI

Codice	Scelta finitura pannelli/prezzo			
<b>PANNELLI NATURAL TOUCH</b>				
	<b>P1</b>	<b>P2</b>	<b>P3</b>	<b>P4</b>
				
	Oak-Alpine	Oak-Concrete	Oxid	Quarz
<b>PANV2F2LDIVDXX-</b>	2.500 €	2.500 €	2.500 €	2.500 €
<b>PANNELLI DOGATI</b>				
	<b>D1</b>	<b>D2</b>		
				
	Dark Brown	Ice		
<b>PADV2F2LDIVDXX-</b>	1.725 €	1.725 €		
<b>PANNELLI FIBER-CROSS</b>				
	<b>T1</b>	<b>T2</b>	<b>T3</b>	
				
	Light Grey	Warm Brown	Steel	
<b>PATV2F2LDIVDXX-</b>	2.800 €	2.800 €	2.800 €	



FUNZIONI	STANDARD	PLUS
whirlpool mini jets	8	16
whirlpool jets	24	36
4 Luce led bianca	●	●
4 Chromolight	OPTIONAL	OPTIONAL
Poggiatesta	-	●
Sistema audio stereo + bluetooth	OPTIONAL	OPTIONAL
Wi-Fi	OPTIONAL	OPTIONAL
Sistema di purificazione Aquaclean (UV+ozono)	OPTIONAL	OPTIONAL
Sistema di purificazione UV	●	●
Pompa a singola velocità	-	●
Pompa a doppia velocità	●	●
Riscaldatore 3 kW	●	●
Scambiatore di calore	OPTIONAL	OPTIONAL
Riempimento automatico	OPTIONAL	OPTIONAL

MODULO WI-FI	
Codice	Prezzo
<b>DOMOWF</b>	450 €

KIT COIBENTAZIONE FONDO VASCA	
Codice	Prezzo
<b>DXXTHCOFV</b>	450 €

KIT COIBENTAZIONE PANNELLI	
Codice	Prezzo
<b>KBT2F2LDOXXL</b>	475 €

COPERTURA TERMICA			
Coibentazione	Codice	Prezzo	
		C1	C2
		Plenty Grey	Brown
Copertura Estiva	<b>DXXTHCO-</b>	1.550 €	1.550 €
Copertura Invernale	<b>DXXTHCOT-</b>	1.850 €	1.850 €

#### VERSIONE **STANDARD**

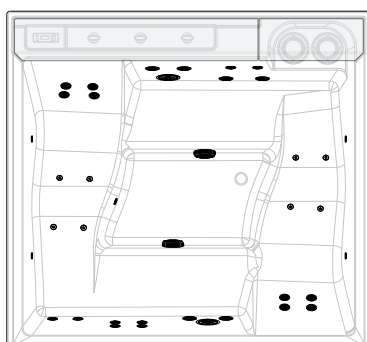

#### VERSIONE **PLUS**

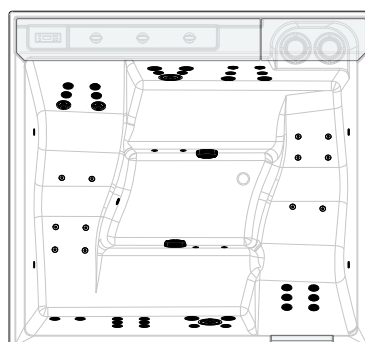



## VITA XL | FINITURE

### VASCA

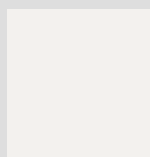

Bianco

### SEDUTA E POGGIATESTA

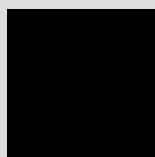

Nero

### PANNELLI NATURAL TOUCH

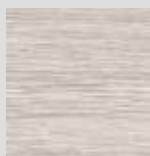

Oak Alpine



Oak Concrete

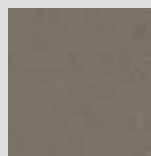

Oxid

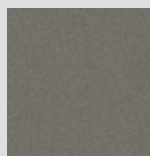

Quarz

### PANNELLI DOGATI

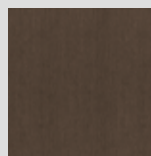

Dark brown

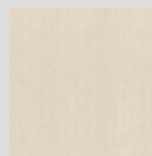

Ice

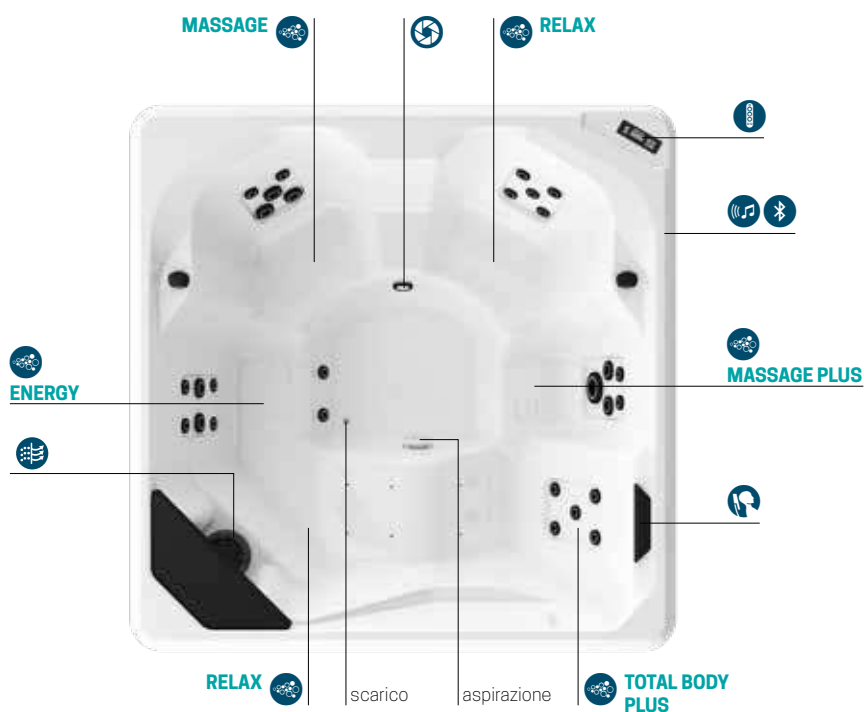

**Massaggio Airpool** a getto d'aria con accensione manuale on/off. Per una **efficace stimolazione cellulare**.



**Massaggio corpo Whirlpool** aria/acqua con regolazione di tempo e intensità manuale o automatica. Per soddisfare qualsiasi esigenza di benessere.



**Skimmer filtro acqua**



**4 Cromolight** con 8 variazioni cromatiche per attivare la mente ed emozionare lo spirito.



**Pannello di controllo**



**Poggiatesta** in materiale antibatterico.



**Seduta** copertura Skimmer



**Diffusori audio bluetooth**  
2 interni e 2 esterni



Design by Marco Pellici



Pannello di controllo



Sistema cromolight e audio Bluetooth



Posizionamento Jet incassato nello schienale

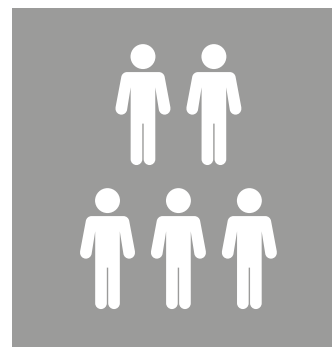

Vasca 5 posti



# VITA XL

# VITA XL

MINIPISCINA MULTIFUNZIONE 200x200x85 - 1600 litri

Dimensioni cm 200 x 200 H 85







Posti 5

Capacità Lt. 950

Codice	Scelta funzioni/Prezzo		Scelta riempimento		Colori Vasca	Colori sedile e poggiatesta
	UV + Cromolight	UV + Cromolight + audio Bluetooth	SENZA Riempimento Automatico	CON Riempimento Automatico		
					Bianco	Nero
<b>STANDARD</b>						
	<b>3X</b>	<b>4X</b>	<b>0</b>	<b>1</b>	<b>-W10</b>	<b>H</b>
<b>VITXL50</b>	11.600 €	+ 325 €		+ 425 €		
<b>STANDARD CON SCAMBIATORE DI CALORE</b>						
	<b>3R</b>	<b>4R</b>	<b>0</b>	<b>1</b>	<b>-W10</b>	<b>H</b>
<b>VITXL50</b>	12.450 €	+ 325 €		+ 425 €		
<b>PLUS</b>						
	<b>3X</b>	<b>4X</b>	<b>0</b>	<b>1</b>	<b>-W10</b>	<b>H</b>
<b>VITXL40</b>	13.900 €	+ 325 €		+ 425 €		
<b>PLUS CON SCAMBIATORE DI CALORE</b>						
	<b>3R</b>	<b>4R</b>	<b>0</b>	<b>1</b>	<b>-W10</b>	<b>H</b>
<b>VITXL40</b>	14.750 €	+ 325 €		+ 425 €		

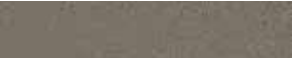
Costruzione del codice **Codice** + **Scelta funzioni** + **Colore vasca** + **Colore seduta poggiatesta** = Codice prodotto finale

## PANNELLI

Codice	Scelta finitura pannelli/prezzo			
<b>PANNELLI NATURAL TOUCH</b>				
	<b>P1</b>	<b>P2</b>	<b>P3</b>	<b>P4</b>
				
<b>PANV2F2LVITXL-</b>	Oak-Alpine 1.575 €	Oak-Concrete 1.575 €	Oxid 1.575 €	Quarz 1.575 €
<b>PANNELLI DOGATI</b>				
	<b>D1</b>	<b>D2</b>		
				
<b>PADV2F2LVITXL-</b>	Dark Brown 1.425 €	Ice 1.425 €		

FUNZIONI	STANDARD	PLUS
whirlpool mini jets	4	6
whirlpool jets	19	28
Regolazione aria	-	2
Chromolight	1	2
Poggiatesta	-	●
Sistema audio stereo + bluetooth	OPTIONAL	OPTIONAL
Modulo Wi-Fi	OPTIONAL	OPTIONAL
Sistema di purificazione UV	●	●
Pompa a doppia velocità	●	●
Riscaldatore 3 kW	●	●
Scambiatore di calore	OPTIONAL	OPTIONAL
Riempimento automatico	OPTIONAL	OPTIONAL
Copertura skimmer	-	●

MODULO WI-FI	
Codice	Prezzo
<b>DOMOWF</b>	450 €

KIT COIBENTAZIONE FONDO VASCA	
Codice	Prezzo
<b>VXTHCOFV</b>	375 €

KIT COIBENTAZIONE PANNELLI		
Coibentazione	Codice	Prezzo
KIT OPZIONALE PER CLIMI RIGIDI	<b>KBT2F2LVIXL</b>	425 €

COPERTURA TERMICA		
Coibentazione	Codice	Prezzo
Copertura Estiva	<b>VXTHCO-C2</b>	1.300 €
Copertura Invernale	<b>VXTHCOT-C2</b>	1.700 €

#### VERSIONE **STANDARD**

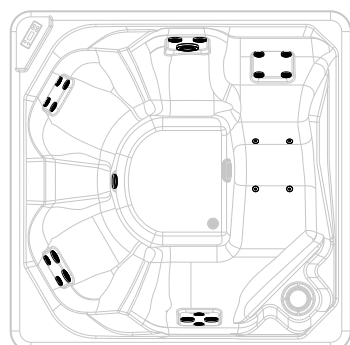

#### VERSIONE **PLUS**

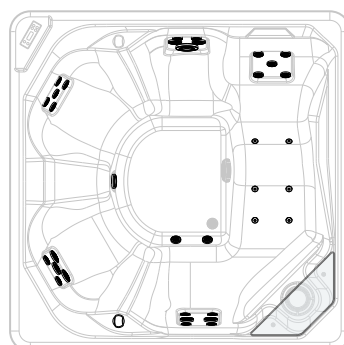



## VITA XXL | FINITURE

### VASCA

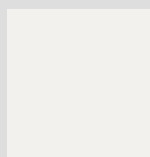

Bianco

### SEDUTA E POGGIATESTA

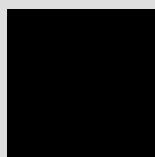

Nero

### PANNELLI NATURAL TOUCH



Oak Alpine



Oak Concrete

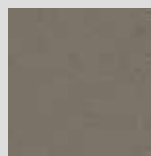

Oxid

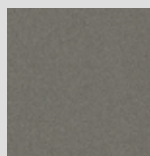

Quarz

### PANNELLI DOGATI

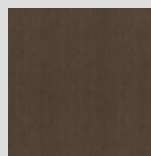

Dark brown

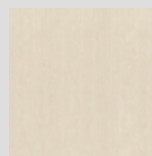

Ice

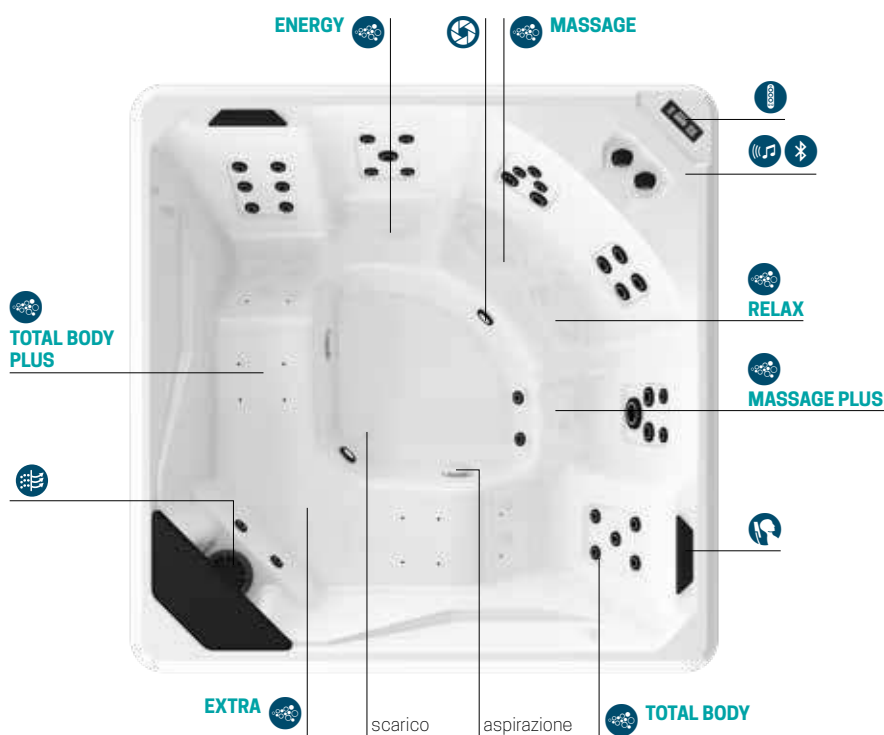

**Massaggio Airpool** a getto d'aria con accensione manuale on/off. Per una **efficace stimolazione cellulare**.



**Massaggio corpo Whirlpool** aria/acqua con regolazione di tempo e intensità manuale o automatica. Per soddisfare qualsiasi esigenza di benessere.



**Skimmer filtro acqua**



**4 Cromolight** con 8 variazioni cromatiche per attivare la mente ed emozionare lo spirito.



**Pannello di controllo**



**Poggiatesta** in materiale antibatterico.



**Seduta** copertura Skimmer



**Diffusori audio bluetooth**  
4 interni e 4 esterni



Design by Marco Pellici



Pannello di controllo



Sistema cromolight e audio Bluetooth



Posizionamento Jet incassato nello schienale

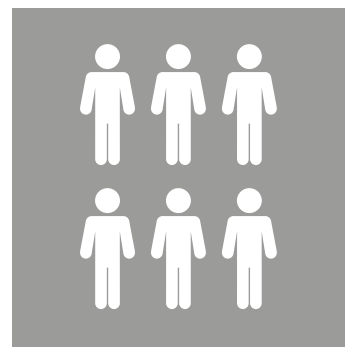

Vasca 6 posti + 1 extra



# VITA XXL

# VITA XXL

MINIPISCINA MULTIFUNZIONE 215x215x85 - 2050 litri

Dimensioni cm 215 x 215 H 85





Posti 6+1

Capacità Lt. 1150





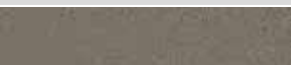
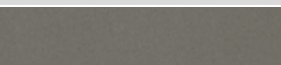









Codice	Scelta riempimento				Colori Vasca	Colori sedile e poggiatesta
	UV + Cromolight	UV + Cromolight + audio Bluetooth	SENZA Riempimento Automatico	CON Riempimento Automatico		
					Bianco	Nero
<b>STANDARD</b>						
	<b>3X</b>	<b>4X</b>	<b>0</b>	<b>1</b>	<b>-W10</b>	<b>H</b>
<b>VITXXL50</b>	14.100 €	+ 325 €		+ 425 €		
<b>STANDARD CON SCAMBIATORE DI CALORE</b>						
	<b>3R</b>	<b>4R</b>	<b>0</b>	<b>1</b>	<b>-W10</b>	<b>H</b>
<b>VITXXL50</b>	14.950 €	+ 325 €		+ 425 €		
<b>PLUS</b>						
	<b>3X</b>	<b>4X</b>	<b>0</b>	<b>1</b>	<b>-W10</b>	<b>H</b>
<b>VITXXL40</b>	16.400 €	+ 325 €		+ 425 €		
<b>PLUS CON SCAMBIATORE DI CALORE</b>						
	<b>3R</b>	<b>4R</b>	<b>0</b>	<b>1</b>	<b>-W10</b>	<b>H</b>
<b>VITXXL40</b>	17.250 €	+ 325 €		+ 425 €		

Costruzione del codice **Codice** + **Scelta funzioni** + **Colore vasca** + **Colore seduta poggiatesta** = Codice prodotto finale

## PANNELLI

Codice	Scelta finitura pannelli/prezzo			
<b>PANNELLI NATURAL TOUCH</b>				
	<b>P1</b>	<b>P2</b>	<b>P3</b>	<b>P4</b>
				
<b>PANV2F2LVITXXL-</b>	Oak-Alpine 1.725 €	Oak-Concrete 1.725 €	Oxid 1.725 €	Quarz 1.725 €
<b>PANNELLI DOGATI</b>				
	<b>D1</b>	<b>D2</b>		
				
<b>PADV2F2LVITXXL-</b>	Dark Brown 1.575 €	Ice 1.575 €		



FUNZIONI	STANDARD	PLUS
 whirlpool mini jets	8	12
 whirlpool jets	24	34
 Regolazione aria	-	2
 Chromolight	1	2
 Poggiatesta	-	●
 Sistema audio stereo + bluetooth	OPTIONAL	OPTIONAL
 Modulo Wi-Fi	OPTIONAL	OPTIONAL
 Sistema di purificazione UV	●	●
 Pompa a doppia velocità	●	●
 Pompa a singola velocità	-	●
 Riscaldatore 3 kW	●	●
 Scambiatore di calore	OPTIONAL	OPTIONAL
 Riempimento automatico	OPTIONAL	OPTIONAL
 Copertura skimmer	-	●

MODULO WI-FI	
Codice	Prezzo
<b>DOMOWF</b>	450 €

KIT COIBENTAZIONE FONDO VASCA	
Codice	Prezzo
<b>VXXTHCOFV</b>	450 €

KIT COIBENTAZIONE PANNELLI		
Coibentazione	Codice	Prezzo
KIT OPZIONALE PER CLIMI RIGIDI	<b>KBT2F2LVIXXL</b>	475 €

COPERTURA TERMICA		
Coibentazione	Codice	Prezzo
Copertura Estiva	<b>VXXTHCO-C2</b>	1.400 €
Copertura Invernale	<b>VXXTHCOT-C2</b>	1.850 €

#### VERSIONE STANDARD

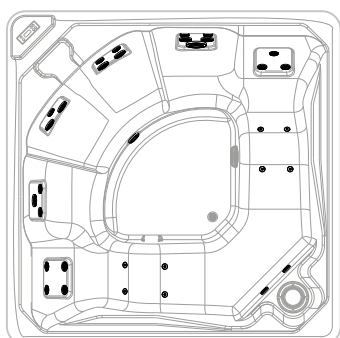

#### VERSIONE PLUS

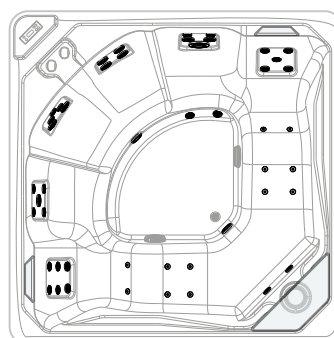



X 187 cm  
Y 84 cm  
Z 60 cm

### CHAISE LONGUE

Chaise longue in multistrato di betulla con laccatura protettiva Oxid wood/Quarz wood, materassino imbottito con rivestimento antiscivolo Fiber-Cross e struttura in acciaio Nero opaco

Codice	Struttura Oxid wood Prezzo			Struttura Quarz wood Prezzo		
	P3T1	P3T2	P3T3	P4T1	P4T2	P4T3
	Light Grey	Warm Brown	Steel	Light Grey	Warm Brown	Steel
<b>CHAISE LONGUE</b>						
<b>CHLOD001-</b>	2.188 €			2.188 €		



X 90 cm  
Y 40 cm  
Z 33 cm

### TAVOLINO TAVOLINO BORDO VASCA CON PORTA-SALVIETTE

Tavolino in multistrato di betulla con laccatura protettiva Oxid wood/Quarz wood e raccordi in alluminio Nero opaco

Codice	Prezzo	
	P3	P4
	Oxid wood	Quarz wood

<b>TAVOLINO</b>		
<b>TAVDOS01-</b>	750 €	750 €
<b>TAVOLINO BORDO VASCA CON PORTA-SALVIETTE</b>		
<b>TAVDOS02-</b>	800 €	800 €

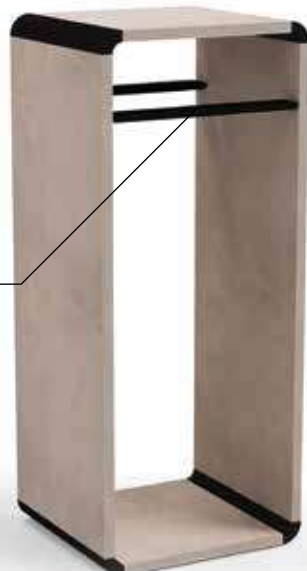

2 barre portasalviette

X 40 cm  
Y 90 cm  
Z 33 cm



GRADINO ALTO

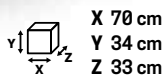

GRADINO BASSO

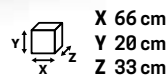

GRADINO DOPPIO

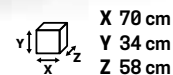

GRADINO DOPPIO LATERALE

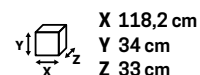

PROLUNGA LATERALE

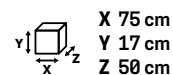

abbinabile al gradino doppio laterale



GRADINI PER VASCA

Gradini in multistrato di betulla con laccatura protettiva Oxid wood/Quarz wood e raccordi in alluminio Nero opaco



**AVVERTENZA: GLI ACCESSORI CHE SONO REALIZZATI IN MULTISTRATO, È OBBLIGATORIO TRATTARLI DUE VOLTE ALL'ANNO CON L'APPOSITO KIT DI MANUTENZIONE. VEDI PAG. 693**

Codice	Prezzo	
	P3	P4
	Oxid wood	Quarz wood
<b>GRADINO ALTO</b>		
<b>SCADOSC1-</b>	450 €	450 €
<b>GRADINO BASSO</b>		
<b>SCADOSC2-</b>	415 €	415 €
<b>GRADINO DOPPIO</b>		
<b>SCADOSC3-</b>	865 €	865 €
<b>GRADINO DOPPIO LATERALE</b>		
<b>SCADOSC4-</b>	900 €	900 €
<b>PROLUNGA LATERALE</b>		
<b>SCADOSC5-</b>	500 €	500 €



TAVOLINO

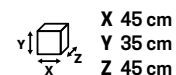

Codice	Prezzo			
	P1	P2	P3	P4
	Oak-Alpine	Oak-Concrete	Oxid	Quarz
<b>TAVVIT01-</b>	575 €	575 €	575 €	575 €



GRADINO ALTO

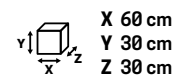

Codice	Prezzo			
	P1	P2	P3	P4
	Oak-Alpine	Oak-Concrete	Oxid	Quarz
<b>SCAVIT01-</b>	375 €	375 €	375 €	375 €



GRADINO BASSO

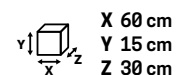

Codice	Prezzo			
	P1	P2	P3	P4
	Oak-Alpine	Oak-Concrete	Oxid	Quarz
<b>SCAVIT02-</b>	275 €	275 €	275 €	275 €



GRADINO DOPPIO

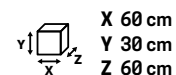

Codice	Prezzo			
	P1	P2	P3	P4
	Oak-Alpine	Oak-Concrete	Oxid	Quarz
<b>SCAVIT03-</b>	575 €	575 €	575 €	575 €

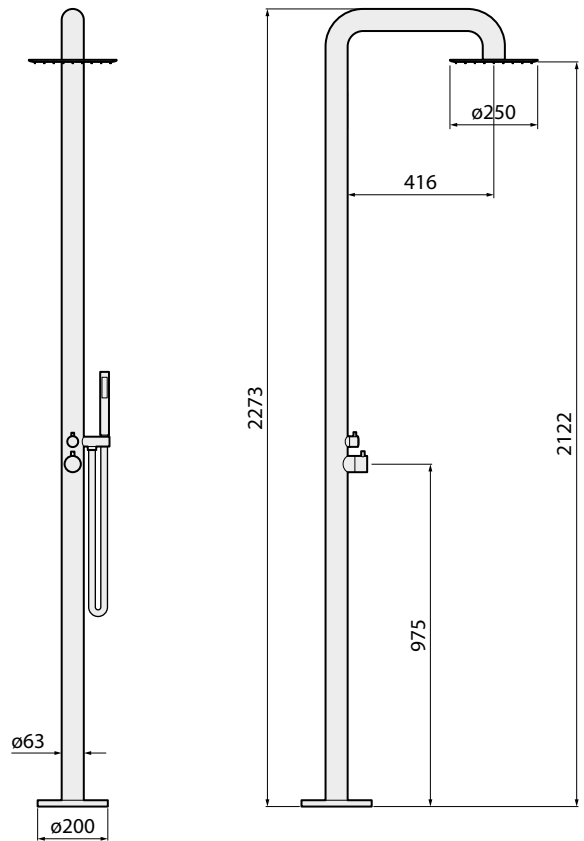

**COLONNA DOCCIA OUTDOOR**

Colonna doccia in acciaio inox spazzolato con miscelatore meccanico e deviatore incorporati, soffione pioggia e doccetta monogetta con flessibile antitorzione

Codice	Prezzo
<b>DOCDOS</b>	2.450 €



**STARTER KIT CLORO**

- 1kg di Cloro Multi-azione
- 750 gr Riduttore PH granulare
- Reagente

Codice	Prezzo
<b>DOKIWT</b>	110 €



**EASY KIT CLORO**

- Cloro in pastiglie da 20 g (azione sanificante) - 1 Kg
- Riduttore del pH liquido 500 ml
- Antischiuma siliconico 200 ml
- Top 5 multiaction, prodotto multifunzione antialga, flocculante, anticalcare, azzurrante
- Tester Cloro/pH
- bicchierino dosatore graduato 0-30 ml

Codice	Prezzo
<b>DOKIEC</b>	183 €



**PRO KIT** (per mini-piscina con filtro a sabbia)

- Cloro in pastiglie da 20 gr.4 azioni - formato da 1Kg
- Riduttore del pH liquido in formato liquido 1 litro
- Antischiuma siliconico 200 ml
- Alga clean Plus 500 ml
- Super Floc 500 ml
- Tester Cloro/pH/Alcalinity in strisce tornasole
- N. 1 Bicchierino Dosatore graduato 0 - 30 ml

Codice	Prezzo
<b>DOKIPR</b>	220 €



**IDRO PH+**

- Incrementatore del PH dell'acqua 1 lt
- bicchierino dosatore graduato 0-30 ml

Codice	Prezzo
<b>DOPH1L</b>	38 €



**KAL STOP**

- Anticalcare non schiumogeno per acqua 1 lt
- bicchierino dosatore graduato 0-30 ml

Codice	Prezzo
<b>DOCAST</b>	38 €



**FILTER CLEAN RAPID**

- Prodotto per la pulizia del filtro a cartuccia con vaporizzatore 500 ml

Codice	Prezzo
<b>DOFICR</b>	38 €



**IDRO SANIT SHOCK**

- Igienizzante/detergente anticalcare e antibatterico per sistemi idromassaggio SPA 5 ltq

Codice	Prezzo
<b>DOIDSS</b>	252 €



**2 FILTRI SKIMMER**

Confezione di 2 cartucce per il filtraggio meccanico dell'acqua da inserire nello skimmer

Codice	Prezzo
<b>DIVINA SPA M e L</b>	
<b>DOFISK2</b>	100 €
<b>DIVINA SPA XL e XXL</b>	
<b>DXFISK2</b>	185 €



**SISTEMA PER LA CURA DEI COMPLEMENTI OUTDOOR**

- Kit per il rinnovo delle superfici dei mobili da giardino a base di sostanze pulenti e curative, con effetto repellente all'acqua, all'olio e allo sporco.

Codice	Prezzo
<b>DOKIMA</b>	85 €



**TELO DI PROTEZIONE**

<b>MOON</b>	
Codice	Prezzo
<b>MOCOPR</b>	1.000 €
<b>DIVINA M SPA</b>	
Codice	Prezzo
<b>DOMCOPR</b>	675 €
<b>DIVINA L SPA</b>	
Codice	Prezzo
<b>DOLCOPR</b>	700 €
<b>DIVINA XL SPA</b>	
Codice	Prezzo
<b>DOXCOPR</b>	775 €
<b>DIVINA XXL SPA</b>	
Codice	Prezzo
<b>DOXXCOPR</b>	850 €
<b>VITA XL</b>	
Codice	Prezzo
<b>VXCOPR</b>	775 €
<b>VITA XXL</b>	
Codice	Prezzo
<b>VXXCOPR</b>	850 €

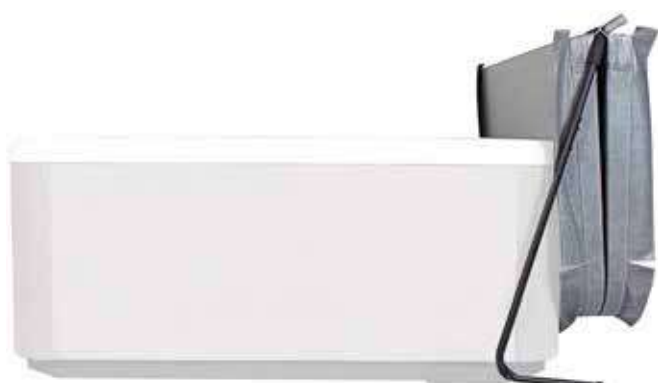

**RIBALTATORE COPERTURA**

Ribaltatore di copertura per i modelli Divina SPA e Vita

Codice	Prezzo
<b>RIBALTATORE COPERTURA</b>	
<b>DOTHCORE</b>	390 €



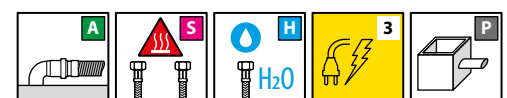
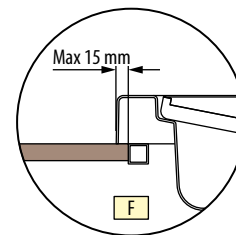
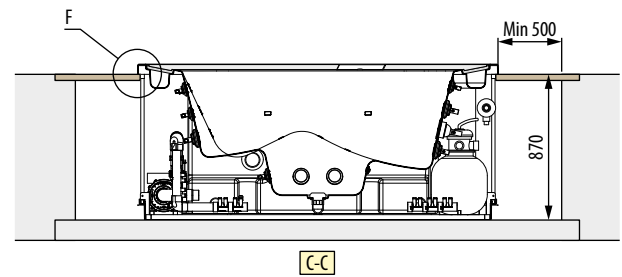
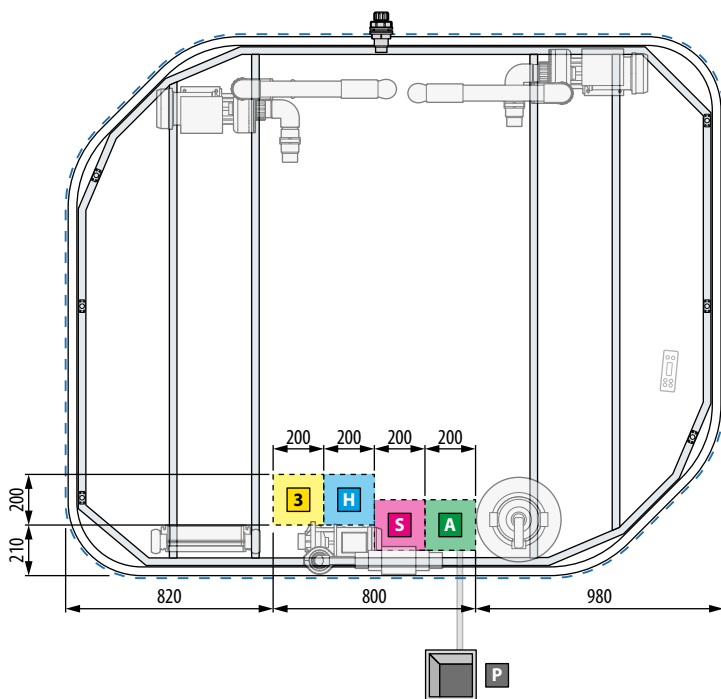
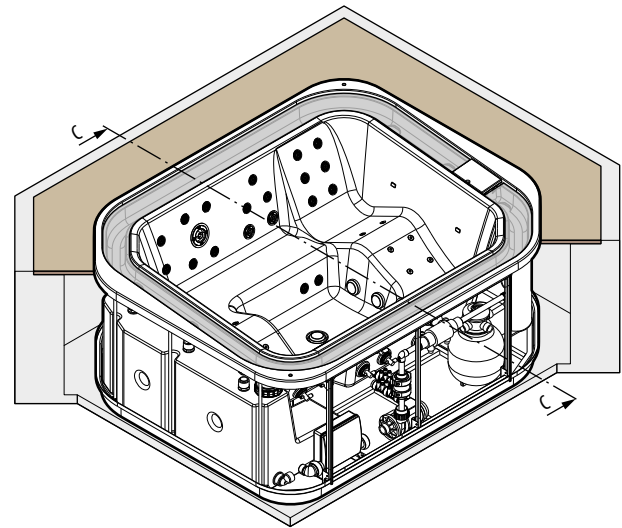
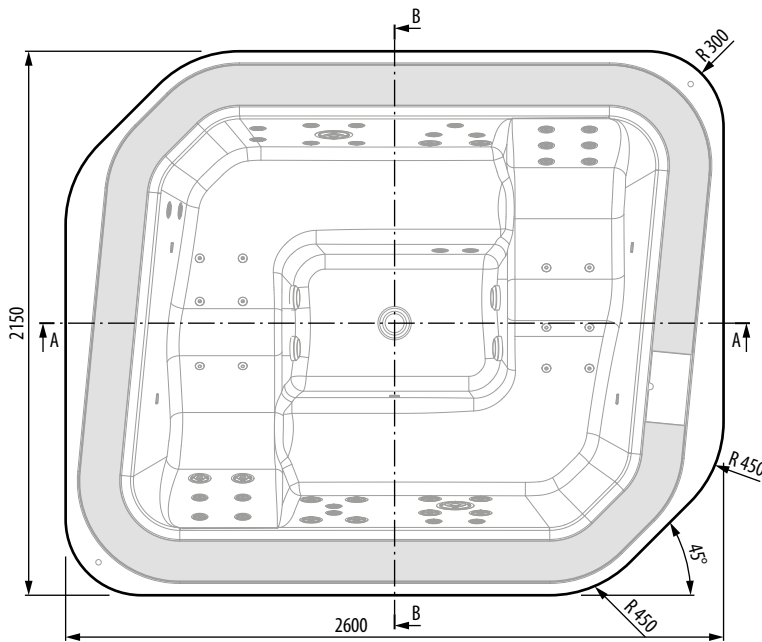
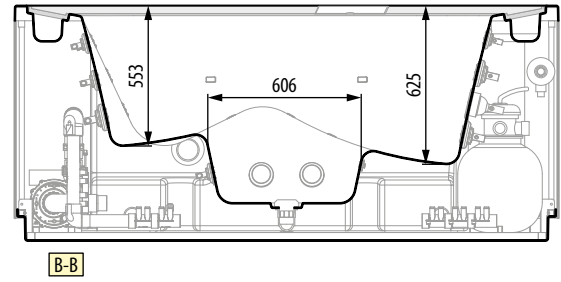
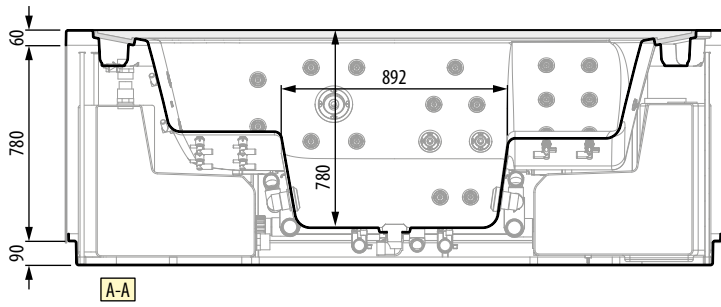

**CARATTERISTICHE IDRAULICHE**

capienza media 1550 lt  
37 bocchette whirlpool  
16 bocchette mini jet

**CARATTERISTICHE ELETTRICHE**

Tensione 230 V  
Frequenza 50 Hz  
Potenza max richiesta 3550 W

**CARATTERISTICHE MECCANICHE**

Area totale 4.85 m<sup>2</sup>  
Peso totale: 2620 kg  
Peso vasca+componenti 450 kg  
Peso utilizzatori (6 pers.) 80x6=480 kg  
Carico specifico su base di appoggio 5290 N/m<sup>2</sup>

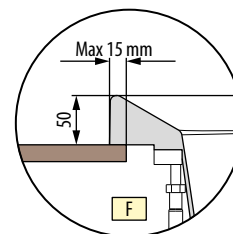
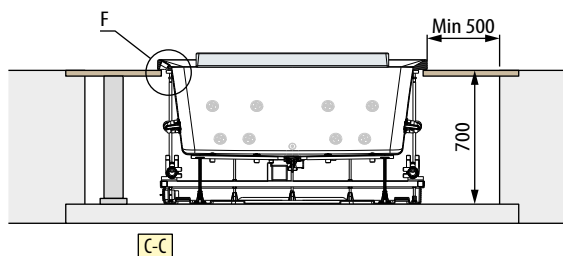
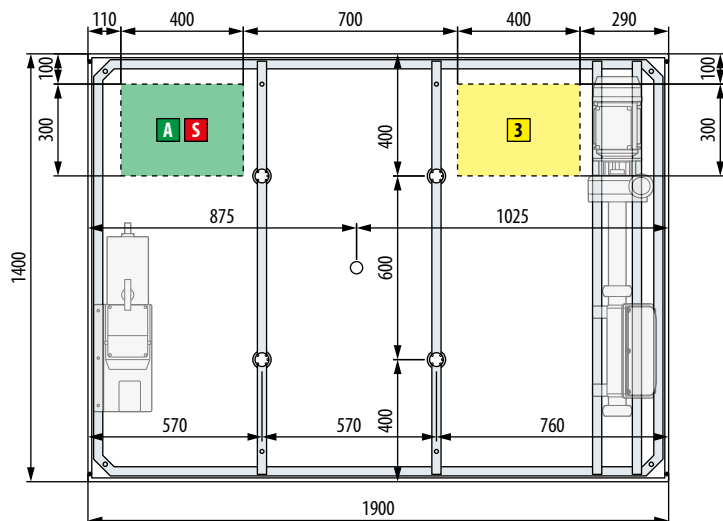
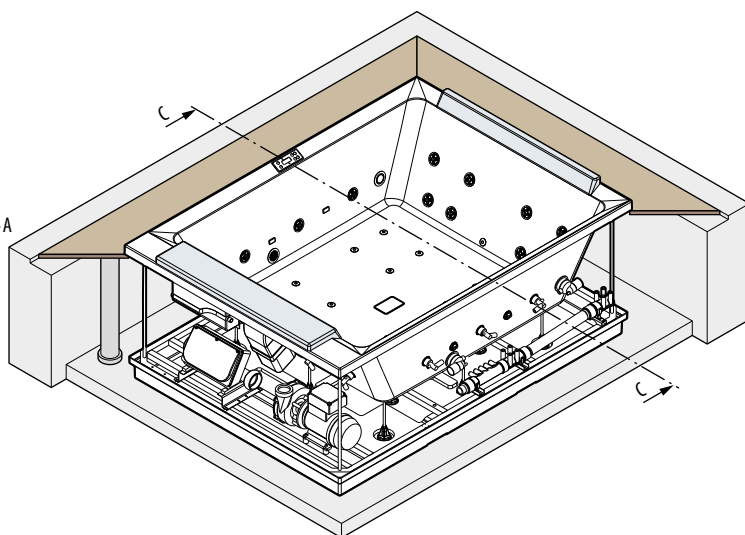
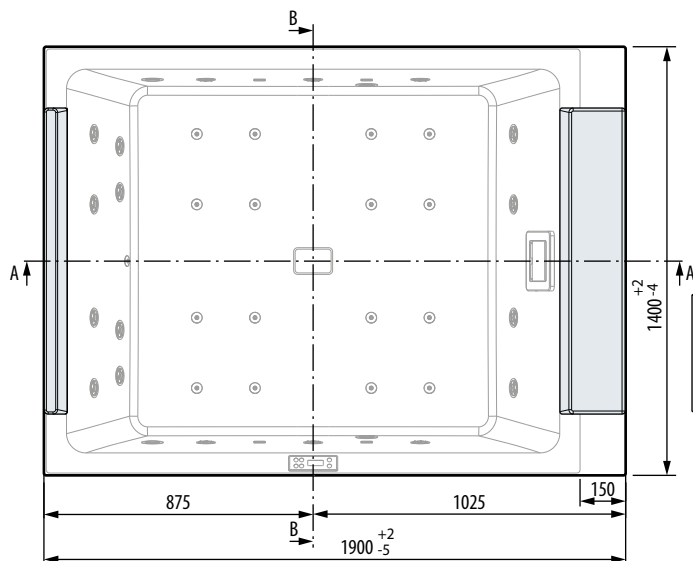
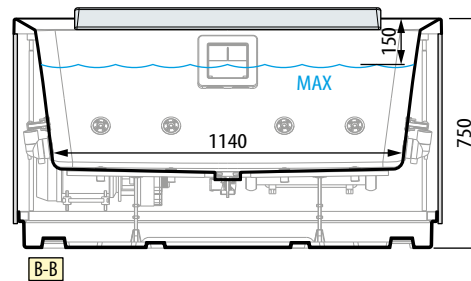
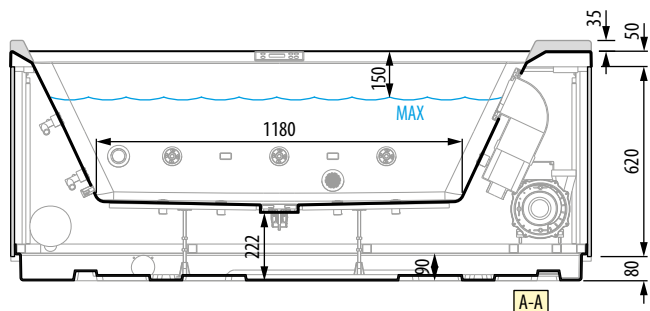

**CARATTERISTICHE IDRAULICHE**

capienza massima 550 lt  
 18 bocchette whirlpool laterali (18 vers. st.)  
 16 bocchette mini jet sul fondo (0 vers. st.)  
 2 bocchette Natural Air

**CARATTERISTICHE ELETTRICHE**

Tensione 230 V  
 Frequenza 50 Hz  
 Potenza max assorbita riscaldatore  
 + pompa bassa velocità: 2400 W

**CARATTERISTICHE MECCANICHE**

Area totale 2.66 m<sup>2</sup>  
 Peso totale: 960 kg  
 Peso vasca+componenti 250 kg  
 Peso utilizzatori (2 pers.) 80+80 kg  
 Carico specifico su base di appoggio  
 3610 N/m<sup>2</sup>

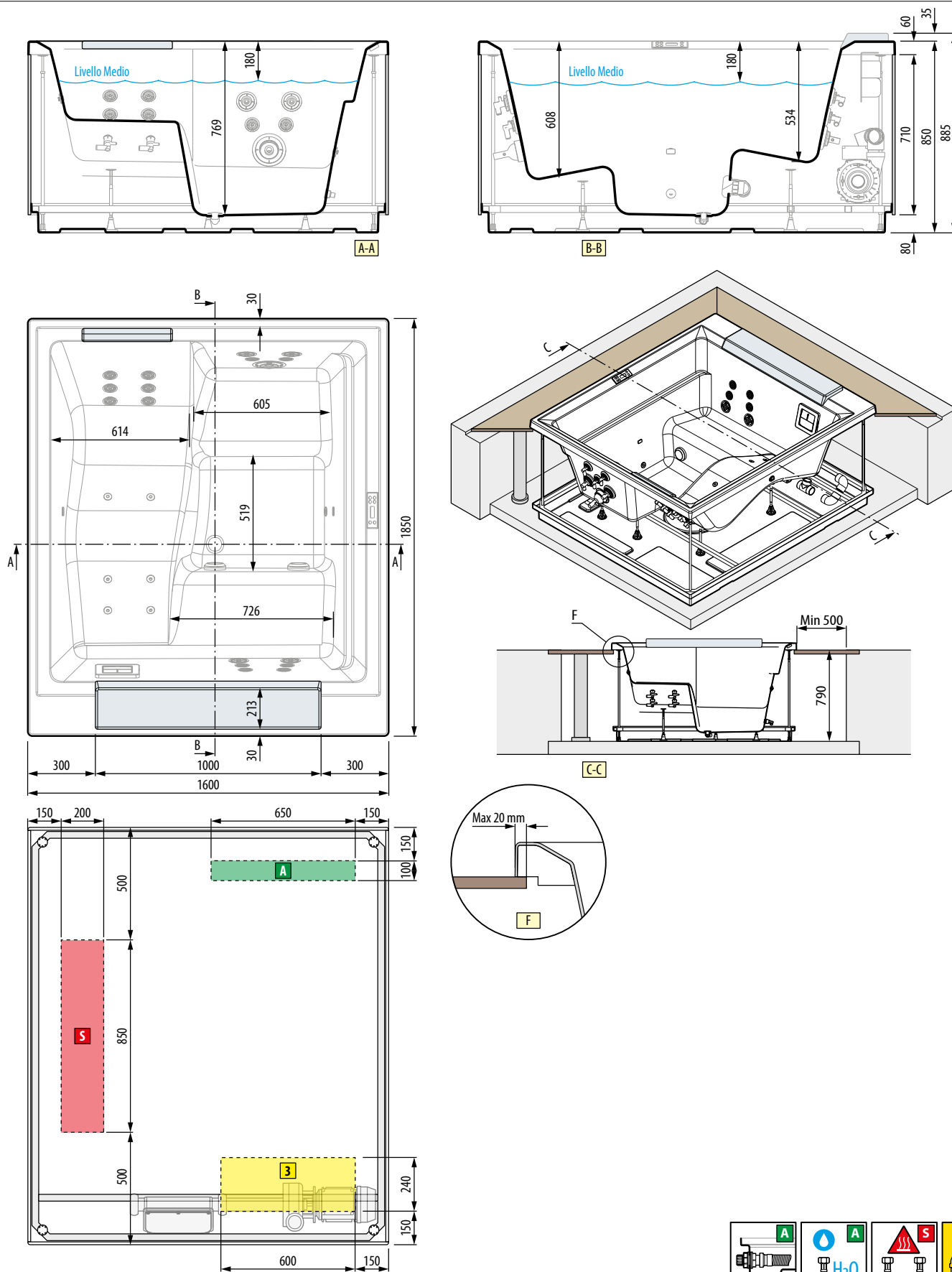

**CARATTERISTICHE IDRAULICHE**

capienza media 680 lt  
 17 bocchette whirlpool (12 versione standard)  
 6 bocchette mini jet (4 versione standard)

**CARATTERISTICHE ELETTRICHE**

Tensione 230 V  
 Frequenza 50 Hz  
 Potenza max richiesta 2400 W

**CARATTERISTICHE MECCANICHE**

Area totale 3.0 m<sup>2</sup>  
 Peso totale: 1200 kg  
 Peso vasca+componenti 290 kg  
 Peso utilizzatori (3 pers.) 80x3=240 kg  
 Carico specifico su base di appoggio 4090 N/m<sup>2</sup>



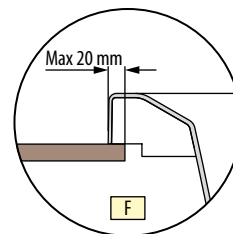
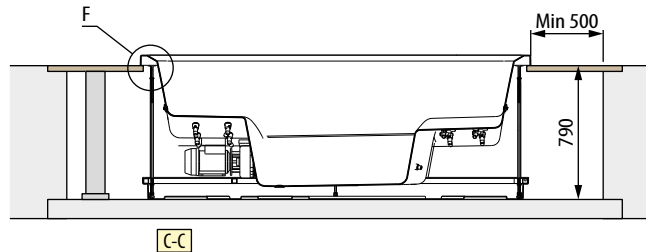
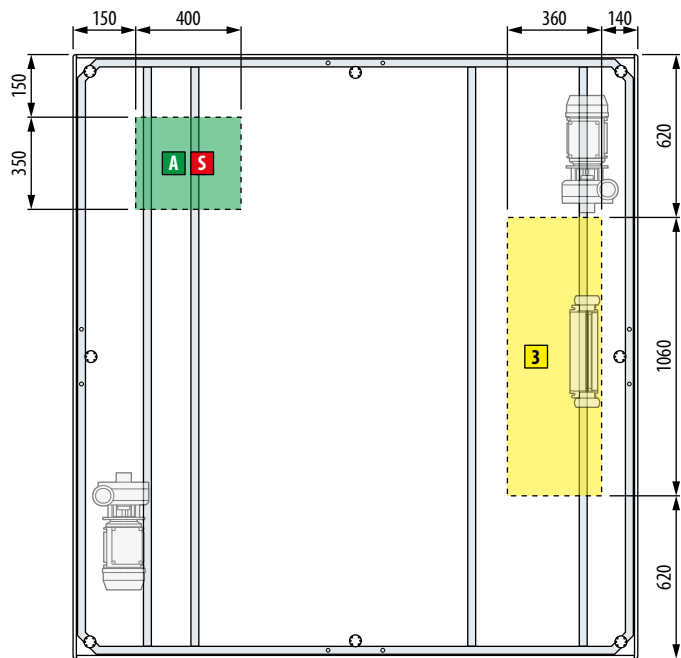
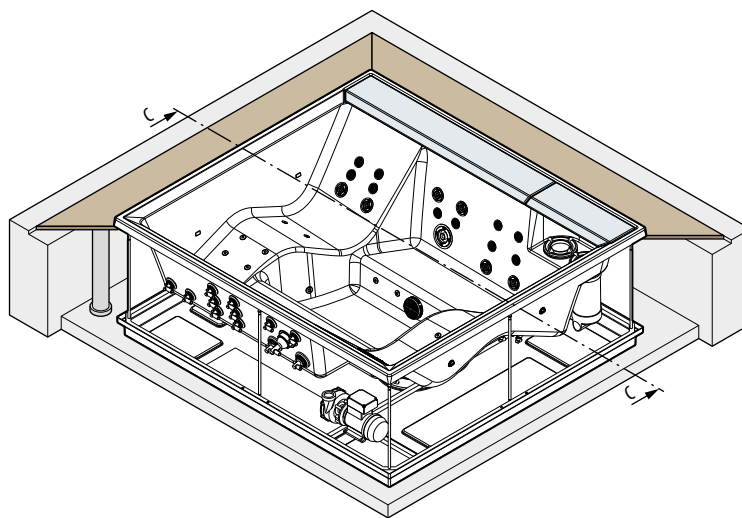
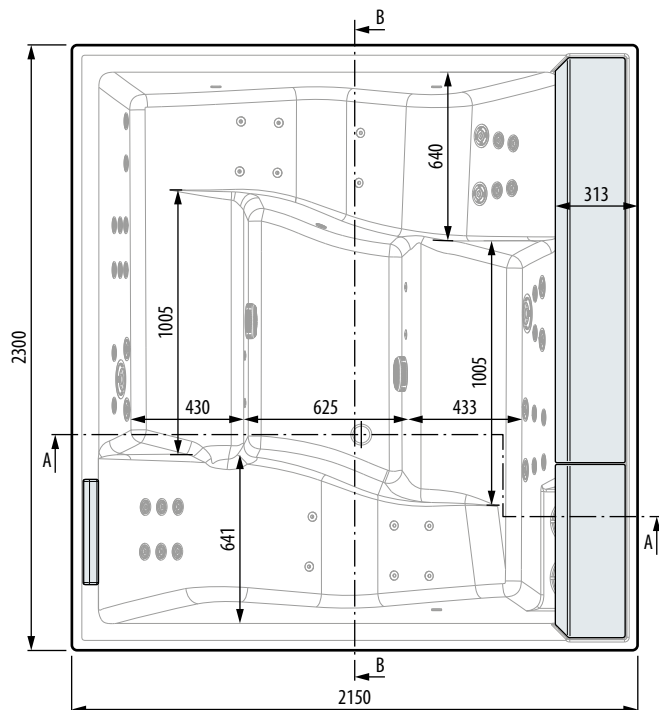
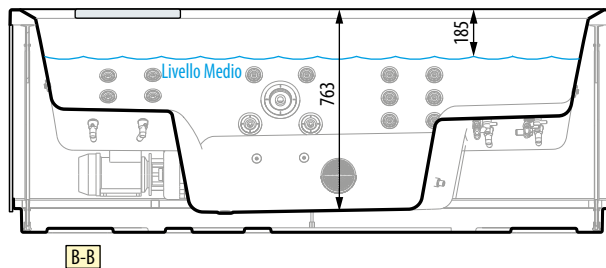
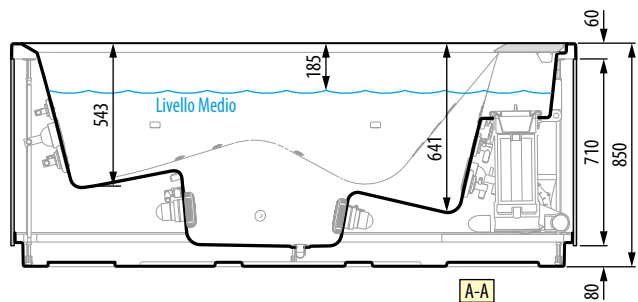

**CARATTERISTICHE IDRAULICHE**

capienza media 1160 lt  
 36 bocchette whirlpool (24 versione standard)  
 16 bocchette mini jet (8 versione standard)

**CARATTERISTICHE ELETTRICHE**

Tensione 230 V  
 Frequenza 50 Hz  
 Potenza max richiesta 4050 W (plus)  
 Potenza max richiesta 3450 W (stand.)

**CARATTERISTICHE MECCANICHE**

Area totale 4.9 m<sup>2</sup>  
 Peso totale: 2080 kg  
 Peso vasca+componenti 440 kg  
 Peso utilizzatori (6 pers.) 80x6=480 kg  
 Carico specifico su base di appoggio 4210 N/m<sup>2</sup>

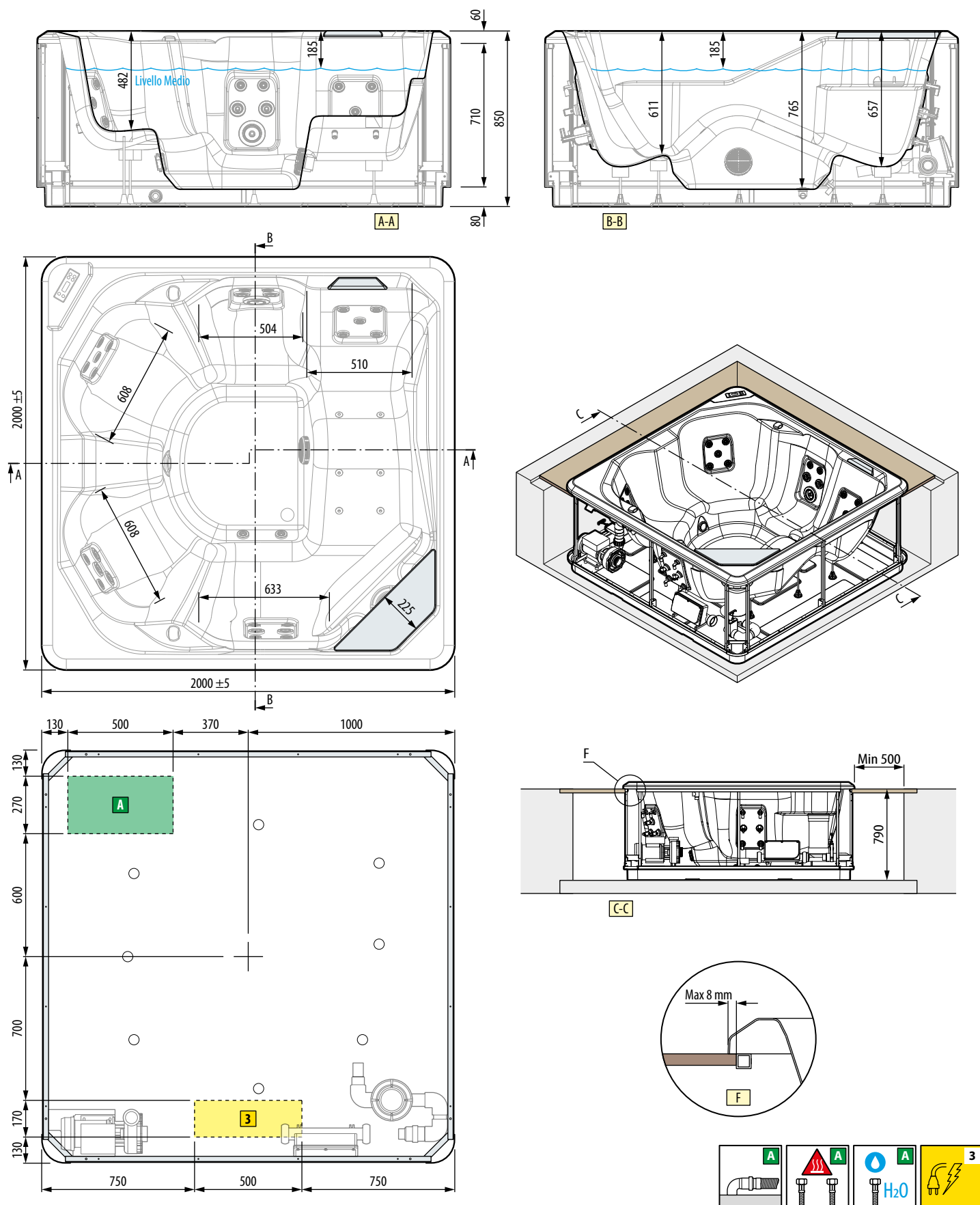

**CARATTERISTICHE IDRAULICHE**

capienza media 950 lt  
 28 bocchette whirlpool (19 versione standard)  
 6 bocchette mini jet (4 versione standard)

**CARATTERISTICHE ELETTRICHE**

Tensione 230 V  
 Frequenza 50 Hz  
 Potenza max richiesta 3450 W

**CARATTERISTICHE MECCANICHE**

Area totale 4 m<sup>2</sup>  
 Peso totale: 1650 kg  
 Peso vasca+componenti 300 kg  
 Peso utilizzatori (5 pers.) 80x5=400 kg  
 Carico specifico su base di appoggio 4130 N/m<sup>2</sup>

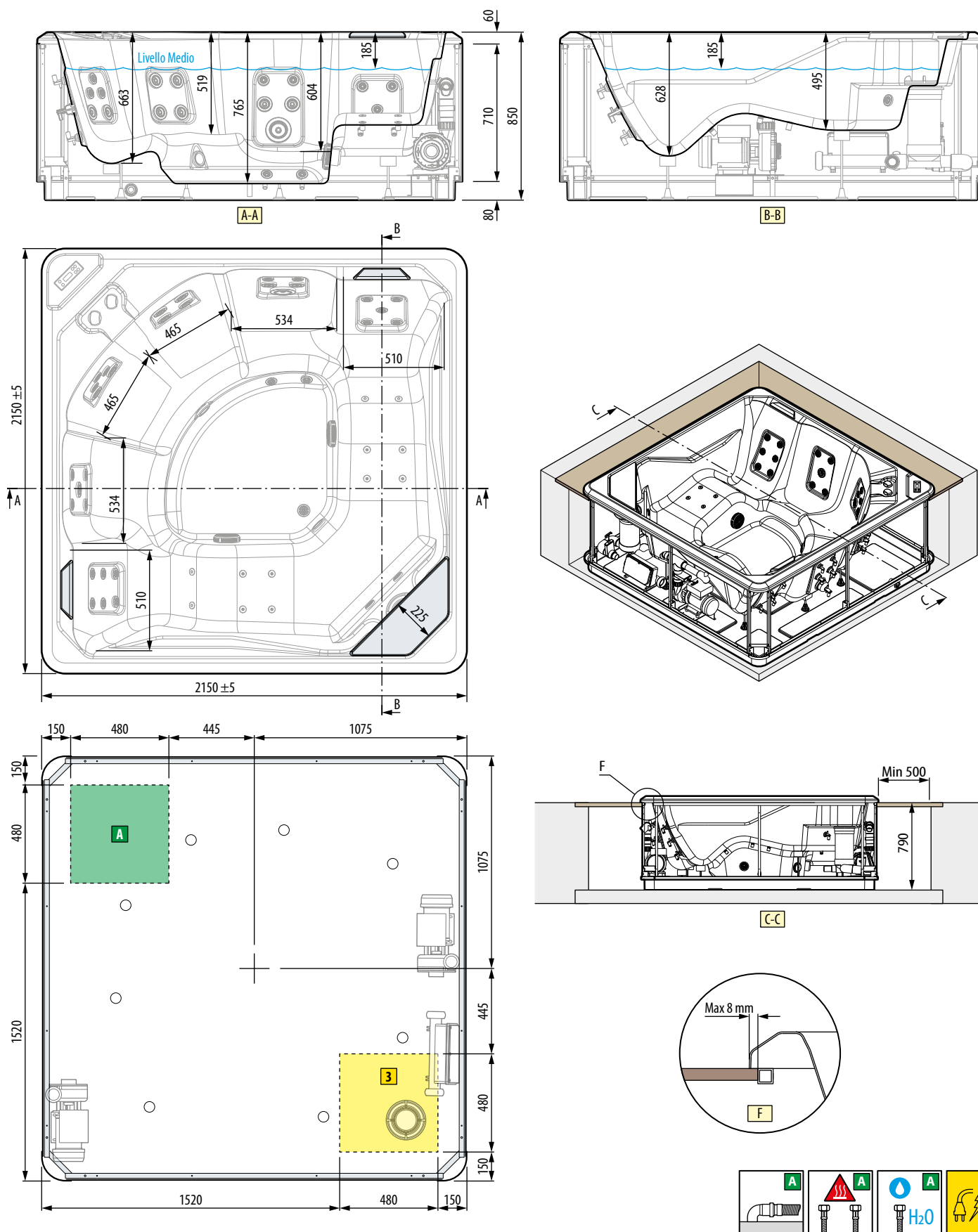

**CARATTERISTICHE IDRAULICHE**

capienza media 1150 lt  
 34 bocchette whirlpool (24 versione standard)  
 12 bocchette mini jet (8 versione standard)

**CARATTERISTICHE ELETTRICHE**

Tensione 230 V  
 Frequenza 50 Hz  
 Potenza max richiesta 4050 W (plus)  
 Potenza max richiesta 3450 W (stand.)

**CARATTERISTICHE MECCANICHE**

Area totale 4.6 m<sup>2</sup>  
 Peso totale: 1980 kg  
 Peso vasca+componenti 350 kg  
 Peso utilizzatori (6+1 pers.) 80x6=480 kg  
 Carico specifico su base di appoggio 4280 N/m<sup>2</sup>



# QUALITÀ E SICUREZZA

## IL NOSTRO IMPEGNO PER LA VOSTRA SICUREZZA

Ogni nostro prodotto è progettato e realizzato per soddisfare le più recenti normative europee in materia di qualità e sicurezza.

Dalle materie prime utilizzate ai semilavorati, all'assemblaggio dei diversi componenti, ogni fase è attentamente pianificata, monitorata e testata per garantire risultati sempre ai massimi livelli degli standard richiesti dal mercato internazionale. I materiali utilizzati per l'imballaggio sono completamente riciclabili e conformi alla direttiva 94/62/CE.

Un impegno quotidiano che intende ripagare la fiducia dei nostri affezionati clienti.

### SAUNA DI VAPORE UMIDO

Le saune di vapore umido Novellini sono conformi alle seguenti direttive europee: **UE 305/2011, 2014/35/UE, 2014/30/UE, 2014/53/UE.**

Con riferimento alle norme armonizzate:

- N 60335-1
- EN 60335-2-105
- EN 62233
- EN 60479
- EN 55014-1
- EN 55014-2
- EN 61000-3-2
- EN 61000-3-3
- EN 301 489-17 V3.2.0
- EN 301 489-1 V2.2.0
- EN 300 328 V2.1.1
- EN 15200



### VASCHE IDROMASSAGGIO

Le vasche idromassaggio Novellini sono conformi alle seguenti direttive Europee: Regolamento **UE 305/2011, 2014/35/UE, 2014/30/UE, 2014/53/UE.** Con riferimento alle norme armonizzate:

- EN12764:2018
- EN 60335-1
- EN 60335-2-60
- EN 62233
- EN 60479
- EN 55014-1
- EN 55014-2
- EN 61000-3-2
- EN 61000-3-3
- EN 301 489-17 V3.2.0
- EN 301 489-1 V2.2.0
- EN 300 328 V2.1.1



<b>CE</b>	
Novellini Spa - Via Mantova, 1023 46034 Romanore di Borgo Virgilio - Mantova - Italy	
07	
EN 12764:2018	
Bagno idromassaggio, destinato ad essere utilizzato per l'igiene personale	
Resistenza all'intrappolamento dei capelli:	Passa
Pulibilità:	Passa
Durabilità della pulibilità:	Passa

### MATERIALI PLASTICI

Tutti i materiali plastici utilizzati per la produzione di prodotti Novellini (Acrilico, Metacrilato, ABS, etc.) sono sottoposti a scrupolosi controlli per verificarne la compattezza, lo spessore e l'omogeneità.

### TERMOARREDI SOLE

I termoarredi Sole sono conformi alle seguenti direttive europee: **UE 305/2011, 2014/35/UE, 2014/30/UE, 2014/53/UE, 2009/125/CE** (regolamento **UE 2015/1188**) con riferimento alle norme armonizzate:

- EN 60335-1
- EN 60335-2-30
- EN 62233
- EN 60479
- EN 55014-1
- EN 55014-2
- EN 61000-3-2
- EN 61000-3-3
- EN 301 489-17 V3.2.0
- EN 301 489-1 V2.2.0
- EN 300 328 V2.1.1

### PARETI DOCCIA

Le pareti doccia Novellini per impieghi domestici di propria fabbricazione sono conformi alla **EN 14428** (Pareti Doccia- Requisiti funzionali e metodi di prova). Questa dichiarazione è basata sulla conformità dei prodotti alla norma seguente: **EN 14428:2018**, con riferimento alle norme armonizzate:

- EN 12150-1:2019
- ISO 7599
- EN ISO 2409
- ISO7892

<b>CE</b>	
Novellini Spa - Via Mantova, 1023 46034 Romanore di Borgo Virgilio - Mantova - Italy	
<b>EN 14428:2018</b>	

### PIATTI DOCCIA

I Piatti doccia doccia Novellini per impieghi domestici di propria fabbricazione sono conformi alla **EN 14527:2019**

**ANNEX B:** Quando bagnata, la superficie della maggioranza dei piatti doccia da un aumento nel potenziale scivolamento. Ciò è in particolare vero quando si utilizzano sapone, shampoo, olio da bagno, ecc. è importante che i progettisti, gli installatori e gli utilizzatori ne siano consapevoli.

<b>CE</b>	
Novellini Spa - Via Mantova, 1023 46034 Romanore di Borgo Virgilio - Mantova - Italy	
<b>12</b>	
<b>EN 14527-CL 1</b>	



È VIETATO METTERE SILICONE ALL'INTERNO DELLE PARETI DOCCIA

**Le pareti doccia e i piatti doccia di propria fabbricazione sono conformi al nuovo Regolamento UE 305/2011**



# DIRETTIVA REACH

## **Applicazione del Regolamento n° 1907/2006 (Direttiva REACH)**

Il 1° giugno 2007 è entrato in vigore in tutta l'Unione Europea il nuovo sistema di regolarizzazione (REACH - REGOLAMENTO (CE) N. 1907/2006) per la valutazione, la registrazione ed il controllo dell'immissione di sostanze e preparati chimici sul mercato europeo. Questo prevede che tutte le sostanze chimiche prodotte o importate nell'Unione Europea in quantità superiore ad 1 tonnellata/anno debbano essere registrate presso l'Agenzia Europea della Chimica (ECHA). Al fine di usufruire di un periodo transitorio durante il quale sarà possibile preparare il dossier di registrazione, è necessario effettuare una registrazione preliminare entro il 01/12/08. Si ricorda che, se entro tale data non è stata effettuata la pre-registrazione, la sostanza in oggetto non potrà essere immessa sul mercato finché non sarà stata effettuata la registrazione.

A tal proposito si comunica che la Novellini S.p.A. riveste solamente il ruolo di utilizzatore a valle non producendo o importando sostanze all'interno dell' UE, quindi non deve assolvere gli obblighi relativi alla registrazione di tali sostanze.

Al fine di garantirVi l'abituale continuità nella fornitura dei nostri

prodotti con la presente siamo a comunicarVi che ci stiamo assicurando che i nostri fornitori, qualora ricorra il caso, effettuino la pre-registrazione. Nel caso ciò non avvenisse sostituiremo le sostanze in uso con altre che rispondano ai requisiti delle norme cogenti. Comunque la nostra fornitura non subirà alcuna modifica a valle degli obblighi REACH.

Per quanto riguarda i nostri prodotti si evidenzia che si inseriscono tutti nella definizione di articolo presente nel Regolamento (CE) N. 1907/2006 del Parlamento Europeo e del Consiglio del 18 dicembre 2006. In particolare ai sensi dell'art. 7 "Registrazione e notifica delle sostanze contenute in articoli", comma 1 lettera b), tali articoli non risultano soggetti a registrazione in quanto eventuali sostanze in essi contenute non sono destinate a essere rilasciate in condizioni d'uso normali o ragionevolmente prevedibili. Si specifica inoltre che, sempre ai sensi del Regolamento (CE) N. 1907/2006, i suddetti articoli, in base alle loro caratteristiche, non rientrano negli obblighi previsti dall'art. 33 "Obbligo di comunicare informazioni sulle sostanze presenti negli articoli" in quanto la percentuale in peso delle sostanze ritenute pericolose, ai sensi della presente normativa, è inferiore allo 0,1% del peso totale dell'articolo.

## CONDIZIONI GENERALI DI VENDITA

### **ORDINI**

Gli ordini sono impegnativi per il Committente, mentre avranno valore di semplice proposta per la Novellini. Gli ordini divengono definitivi solo dopo esplicita accettazione oppure, nel caso di assenza di accettazione esplicita, dopo un periodo di 15 giorni dal ricevimento in sede dell'ordine medesimo. Gli ordini possono essere evasi anche parzialmente ed in più riprese.

### **ANNULLAMENTO ORDINI**

Nessun annullamento di ordini verrà accettato senza la preventiva ed esplicita autorizzazione della Novellini, che si riserva comunque la facoltà di addebitare eventuali spese ed oneri conseguenti.

### **ORDINI SPECIALI**

L'ordine di prodotti speciali deve sempre pervenire in forma scritta e deve essere accompagnato da un anticipo pari al 25% almeno dell'intero importo. Su tali ordini non si accetteranno resi o annullamenti di nessun tipo.

### **TEMPI DI CONSEGNA**

I tempi di consegna sono puramente indicativi e non costituiscono in nessun caso motivo di annullamento totale o parziale dell'ordine, né per richiesta di risarcimento ad alcun titolo. Qualora il termine di consegna sia essenziale per l'acquirente, andrà specificatamente segnalato per iscritto al momento del conferimento dell'ordine.

### **PREZZI E PAGAMENTI**

I prezzi di vendita corrispondono a quelli riportati sul listino ufficiale alla data della stipulazione dell'ordine. La Novellini si riserva la facoltà di effettuare variazioni di tali prezzi anche senza preavviso. Gli ordini già in essere e con una programmazione di consegna oltre i 60 giorni dalla data di entrata in vigore dei nuovi listini, verranno assoggettati al nuovo regime di prezzi.

Le condizioni di pagamento sono quelle pattuite specificatamente per ogni cliente. In caso di clienti nuovi, o di variazioni delle condizioni stesse, tali condizioni andranno espressamente dichiarate al momento dell'ordine e successivamente approvate dalla Novellini.

In caso di ritardato pagamento, verranno addebitati gli interessi di legge. Tutte le vendite effettuate avverranno in regime di riserva di proprietà, rimanendo di proprietà esclusiva della Novellini fino al completo pagamento delle stesse.

### **IMBALLO**

Il prezzo pattuito per i prodotti Novellini si intende comprensivo di normale imballo. Nel caso di particolari esigenze di trasporto e di conseguente imballo, verrà pattuito un prezzo speciale in funzione del costo aggiuntivo sopportato. I pallets in ferro utilizzati per il trasporto dei prodotti Novellini,

si considerano "a rendere" in quanto di proprietà del venditore. In caso di mancato restituzione, l'azienda si riserva la facoltà di riaddebitarne il valore. Tali pallets in ferro sono stati progettati ad esclusivo uso prodotti del venditore. Il venditore si solleva da ogni responsabilità per un uso improprio di questo bene.

### **TRASPORTO**

Si rinvia all'art. 1510 del Codice Civile.

### **GARANZIA**

La merce si intende coperta da garanzia secondo quanto previsto dal Codice Civile Italiano, dalle leggi speciali e dalla normativa europea in materia. Tale garanzia è estesa a 2 anni dalla data di consegna del prodotto e verrà presa in considerazione solo dietro reclamo scritto. Non verrà riconosciuta alcuna garanzia qualora, in caso di vizio di conformità riconoscibile risultante all'apertura dell'imballo, il prodotto venga comunque installato e ne sia fatta denuncia solo successivamente.

### **RESI DI MERCE**

L'eventuale reso di prodotti Novellini dovrà essere sempre effettuato dopo specifica autorizzazione, da richiedere caso per caso.

In caso di reso per errore cliente rimarranno comunque a carico del committente, per spese generali di ripristino e immagazzinaggio, purchè il prodotto sia integro; nel caso in cui il prodotto risulti danneggiato o non integro, l'azienda si riserva di valutare di volta in volta il valore da accreditare.

### **CONTROVERSIE LEGALI**

Le condizioni suddette vengono integralmente accettate dal committente al momento del conferimento dell'ordine alla Novellini. Per ogni controversia in merito, l'unico Foro competente è quello di Mantova.

Tutti i prodotti sono assicurati per i danni cagionati al consumatore conformemente alla direttiva comunitaria CEE 85/374 del 1985, e s.m.i, con XL Group - Insurance Company PLC.

In caso di fuori squadra dei muri o del piatto, ondulazioni degli stessi, la Novellini S.P.A. declina ogni responsabilità per eventuali difficoltà o impossibilità di installazione del prodotto, così come non risponderà per eventuali perdite di acqua o malfunzionamenti vari.

La Novellini si riserva di apportare modifiche parziali o radicali ai prodotti, nonché di deciderne l'eliminazione dal catalogo anche senza preavviso. Gli allestimenti e le tonalità di colori delle fotografie sono puramente indicativi.

Il presente listino annulla e sostituisce i precedenti. Le immagini e i dati contenuti nel presente catalogo sono da ritenersi indicativi e possono subire variazioni anche senza alcun preavviso.



[store.novellini.com](https://store.novellini.com)













TIENITI SEMPRE AGGIORNATO  
CONSULTANDO LE PROMOZIONI  
SUL PORTALE A TE DEDICATO

Comodo, sicuro, veloce e facile.

È il portale online che, in tempo reale, ti consente di consultare  
l'ampia gamma di prodotti Novellini e le loro offerte.

Richiedi l'accesso al tuo referente.

## LEGENDA SIMBOLI BOX DOCCIA

 Altezza box	 Non reversibile	 Impermeabilità soddisfacente
 Spessore vetro	 Sollevamento anta in apertura / chiusura	 Impermeabilità non garantita al 100%
 Estensibilità	 Soft opening-closing	
 Reversibile	 Impermeabilità ottima	

## LEGENDA SIMBOLI CABINE DOCCIA E COLONNE MULTIFUNZIONE

 Altezza cabina	 Doccia a cascata	 Ripiano portaoggetti
 Altezza utile interna	 Sauna di vapore + erogatore con dispenser di aromi	 Poggiapiedi
 Spessore vetro	 Chromolight	 Bluetooth
 Idromassaggio verticale e dorsale	 Illuminazione LED interna	 Radio RDS stereo con diffusori acustici
 Idromassaggio cervicale	 Telecomando Touch Screen	 Specchio
 Idromassaggio plantare	 Pannello elettronico	 Tettuccio
 Rotopioggia	 Doccetta a mano con flessibile	 Pedana
 Soffione pioggia	 Sedile	 Disegni tecnici

## LEGENDA SIMBOLI VASCHE

 Idromassaggio Airpool	 Pannello accensione soft-touch	 Colonna di scarico (tranne vasche ad incasso)
 Idromassaggio Airpool dorsale	 Disinfezione	 Colonna di scarico con piletta click-clack
 Idromassaggio Whirlpool laterale	 Rubinetteria bordo vasca	 Bluetooth
 Idromassaggio Whirlpool dorsale	 Telecomando Touch Screen	 Radio RDS stereo
 Idromassaggio Whirlpool plantare	 Pannello elettronico con funzioni Hydro Sequence	 Presa AUX per MP3
 Natural Air	 Telecomando ON/OFF	 Tubo di scarico salvagoccia
 Chromolight	 Poggiatesta impermeabile, antibatterico e atossico	 Disegni tecnici
 Riscaldatore	 Sedile	



### **NOVELLINI GmbH**

Salzburger Straße 30 - A-6300 Wörgl  
Tel. +43 5332 23200 | Fax +43 5332 23200 9 | office.at@novellini.com

### **NOVELLINI SpA**

Via Mantova, 1023 - 46034 Borgo Virgilio - Loc. Romanore - Mantova - Italy  
Tel. +39 0376 64 21 | Fax +39 0376 64 22 50 | info@novellini.com

  
Designed and  
manufactured  
in **ITALY**



[www.novellini.com](http://www.novellini.com)



[www.novellini.com/facebook](http://www.novellini.com/facebook)



[www.novellini.com/instagram](http://www.novellini.com/instagram)



[www.novellini.com/YouTube](http://www.novellini.com/YouTube)



[www.novellini.com/Linkedin](http://www.novellini.com/Linkedin)



[www.novellini.com/Pinterest](http://www.novellini.com/Pinterest)